

COUNTY OF SAN LUIS OBISPO GENERAL PLAN

**NOISE ELEMENT, PART I
POLICY DOCUMENT**

ADOPTED BY
THE SAN LUIS OBISPO COUNTY BOARD OF SUPERVISORS
MAY 5, 1992 - RESOLUTION 92-227

[Table of Contents](#)

PREPARED BY
BROWN-BUNTIN ASSOCIATES, INC

COUNTY OF SAN LUIS OBISPO

Board of Supervisors

Harry Ovitt, District 1
Shirley Bianchi, District 2
James Patterson, District 3
K. H. Achadjian, District 4
Jerry Lenthall, District 5

Department of Planning and Building

Victor Holanda, AICP, Director
Pat Beck, Assistant Planning Director
Kami Griffin, Supervising Planner
Jennifer Jimenez, Administrative Assistant

TABLE OF CONTENTS

<i>Chapter</i>		<i>Page</i>
	EXECUTIVE SUMMARY	iii
Chapter 1:	INTRODUCTION	1 - 1
	1.1 Purpose and Scope	1 - 1
	1.2 Authority	1 - 2
	1.3 Relationship to Other Elements of the General Plan	1 - 2
	1.4 Noise And Its Effects On People	1 - 3
	1.5 Definitions	1 - 3
Chapter 2:	THE NOISE ENVIRONMENT	2 - 1
	2.1 Overview of Sources	2 - 1
	2.2 Methods Used to Develop Noise Exposure Information	2 - 1
	2.3 Determining Noise Exposure and Mitigation for Specific Locations	2 - 1
	2.4 Community Noise Survey	2 - 7
Chapter 3:	GOALS AND POLICIES	3 - 1
	3.1 Goals	3 - 1
	3.2 Land Use Compatibility - Transportation	3 - 1
	3.3 Policies	3 - 3
Chapter 4:	IMPLEMENTATION MEASURES	4 - 1

<u>Table</u>	<u>Page:</u>
2-1 Adjustments to Traffic Noise Exposure for Topography	2 - 2
2-2 Determining Noise Mitigation for New Development of Noise-Sensitive Uses: Plot and Site Plans	2 - 5
3-1 Maximum Allowable Noise Exposure-Transportation Noise Sources	3 - 5
3-2 Maximum Allowable Noise Exposure-Stationary Noise Sources	3 - 6
4-1 Schedule for Carrying Out Noise Element Implementation Measures	4 - 5
4-2 Requirements for an Acoustical Analysis	4 - 6

<u>Figure</u>	
2-1 Chart for Locating Noise Exposure Information	2 - 3
2-2 Flow Chart for Determining Noise Exposure and Mitigation for New Development of Noise-Sensitive Uses: Minor Use Permits & Development Plans	2 - 4
3-1 Land Use Compatibility for New Development Near Transportation Noise Sources	3 - 2

<u>Appendix</u>	
A Noise Contour Maps - Transportation Noise Sources (2010)	A - 1
B Noise Contour Maps - Stationary Noise Sources (1990)	B - 1
C Noise Contour Maps - Future CNEL Contours for Paso Robles Municipal Airport, Oceano and San Luis Obispo County Airports (Figures C-1, C-2, C-3)	C - 1
D Noise Contour Data - Distance from Center of Roadway to L _{DN} Contours	D - 1
E Distance (Feet) from Center of Track to Future L _{DN} Contours Southern Pacific Railroad ..	E - 1

Table of Contents Part II

EXECUTIVE SUMMARY

The San Luis Obispo County Noise Element of the General Plan provides a policy framework for addressing potential noise impacts in the planning process. Its purpose is to minimize future noise conflicts. The Noise Element consists of a Policy Document and Acoustical Design Manual. A Technical Reference Document has also been prepared, but is not adopted as part of the Noise Element.

The Policy Document includes maps showing the extent of noise exposure from the major noise sources in the county (roadways, railways, airports, and stationary sources), along with the goals, policies and implementation program adopted by the county to reduce future noise impacts. Among the most significant policies of the Noise Element are numerical noise standards that limit noise exposure within noise-sensitive land uses, and performance standards for new commercial and industrial uses that might adversely impact noise-sensitive land uses. When the potential for adverse noise impacts is identified, mitigation is required to carry out the specific recommendations of an expert in acoustics or, under some circumstances, by implementing standard noise mitigation packages. When mitigation is required, highest priority is given to avoiding or reducing noise impacts through site planning and project design, and lowest priority given to structural mitigation measures such as construction of sound walls and acoustical treatment of buildings.

The purpose of the Acoustical Design Manual is to provide county staff, developers, builders, and homeowners with a guide for reducing outdoor and indoor noise in relatively simple situations. The Manual contains standard noise mitigation packages which in some situations may be used in lieu of an acoustical analysis prepared by a professional.

The Technical Reference Document is a separate volume which contains background information on the data and methods used to prepare noise exposure information and an inventory of the major noise sources in the county. Information about the measurement and effects of noise is also included in the document. The Technical Reference Document is intended to be a resource when evaluating the noise-related implications of a project.

CHAPTER 1: INTRODUCTION

1.1 Purpose and Scope

The Noise Element of the General Plan provides a policy framework within which potential noise impacts may be addressed during project review and long range planning. The Policy Document and Acoustical Design Manual which comprise Parts I and II of this element have been adopted by San Luis Obispo County in conformance with Section 65302 (f) of the California Government Code.

The Acoustical Design Manual is Part II of the Noise Element. It provides standard noise mitigation packages which may be used under some circumstances to comply with the policies of the Noise Element. It also contains background information to assist staff and the general public in evaluating the effectiveness of proposed noise mitigation measures.

The Technical Reference Document is a separate volume. It provides detailed information concerning the methods used to define existing and future noise exposure within San Luis Obispo County.

The Noise Element is directed at minimizing future noise conflicts, whereas a noise ordinance focuses on resolving existing noise conflicts. A noise ordinance may be used to address noise levels generated by existing industrial, commercial and residential uses which are not regulated by federal or state noise level standards. The regulation of noise sources such as traffic on public roadways, railroad line operations and aircraft in flight is preempted by existing federal and/or state regulations, meaning that such sources generally may not be addressed by a noise ordinance. The Noise Element addresses the prevention of noise conflicts from all of these sources.

The noise level standards of a noise ordinance should be consistent with the adopted policies of the Noise Element to achieve consistency in the implementation of noise control programs, and to provide industry with design criteria for future development or expansion.

According to the Government Code requirements, noise exposure information should be included in the Noise Element for the following major noise sources:

1. Highways and freeways
2. Primary arterials and major local streets
3. Railroad operations
4. Aircraft and airport operations
5. Local industrial facilities
6. Other stationary sources

Noise-sensitive uses that have been identified by the county are the following:

1. Residential development, except temporary dwellings
2. Schools-preschool to secondary, college and university; specialized education and training
3. Health care services (hospitals)
4. Nursing and personal care
5. Churches
6. Public assembly and entertainment
7. Libraries and museums

8. Hotels and motels
9. Bed and breakfast facilities
10. Outdoor sports and recreation
11. Offices

1.2 Authority

The contents of the Noise Element and the methods used in its preparation have been determined by the requirements of Section 65302(f) of the California Government Code and by the *Guidelines for the Preparation and Content of the Noise Element of the General Plan* prepared by the California Department of Health Services and included in the 1990 State of California *General Plan Guidelines*, published by the State Office of Planning and Research. The *Guidelines* require that major noise sources and areas containing noise-sensitive land uses be identified and quantified by preparing generalized noise exposure contours for current and projected conditions. Contours may be prepared in terms of either the Community Noise Equivalent Level (CNEL) or the Day-Night Average Level (L_{DN}), which are descriptors of total noise exposure at a given location for an annual average day. The CNEL and L_{DN} are generally considered to be equivalent descriptors of the community noise environment within plus or minus 1.0 Db (see Section 1.5 for definitions of the terminology used in this document).

1.3 Relationship to Other Elements of the General Plan

The Noise Element is related to the Land Use, Housing, Circulation and Open Space Elements of the General Plan. Recognition of the interrelationship of noise and the other mandated elements is necessary to prepare an internally consistent general plan and to initiate changes which will reduce noise exposure to acceptable levels in areas where noise presently exceeds the levels set forth by the adopted policies of the Noise Element. The relationship between these elements is briefly discussed below:

1. Land Use: An objective of the Noise Element is to provide noise exposure information for use in the Land Use Element. The noise contours in the Noise Element should be used to help determine appropriate land use patterns in the Land Use Element.
2. Housing: The Housing Element addresses sites and standards for new housing. Since residential land uses are noise-sensitive, the noise exposure information of the Noise Element must be considered when planning the locations of new housing. The State Noise Insulation Standards may influence the locations and construction costs of multi-family dwellings, which should be considered by the Housing Element.
3. Circulation: The circulation system, which is a major source of noise, must be correlated with the Land Use Element. This is especially true for roadways which carry significant numbers of trucks. Noise exposure will thus be a decisive factor in the location and design of new transportation facilities, and in the mitigation of noise produced by existing facilities upon existing and planned land uses.

4. Open Space: Excessive noise adversely affects the enjoyment of recreational pursuits in designated open space, particularly in areas where quiet is a valued part of the recreational experience. Thus, noise exposure should be considered in planning for this kind of open space use. Conversely, open space can be used to buffer noise-sensitive uses from noise sources by providing setbacks and visual screening.

1.4 Noise And Its Effects On People

The Technical Reference Document provides discussions of the fundamentals of noise assessment, the effects of noise on people and criteria for acceptable noise exposure. It is intended that the Technical Reference Document serve as a reference for staff during the review of documents or proposals which refer to the measurement and effects of noise.

1.5 Definitions

A WEIGHTED SOUND LEVEL (DB): The sound level obtained by using the A-weighting filter of a sound level meter, expressed in decibels (dB). All sound levels referred to in this policy document are in A-weighted decibels. A-weighting de-emphasizes the very low and very high frequencies of sound in a manner similar to the human ear. Most community noise standards utilize A-weighting, as it provides a high degree of correlation which human annoyance and health effects.

COMMUNITY NOISE EQUIVALENT LEVEL (CNEL): The equivalent energy (or energy average) sound level during a 24-hour day, obtained after addition of approximately five decibels to sound levels in the evening from 7:00 p.m. to 10:00 p.m. and ten decibels to sound levels in the night before 7:00 a.m. and after 10:00 p.m. The CNEL is generally computed for annual average conditions.

DAY/NIGHT AVERAGE SOUND LEVEL (L_{DN}): The equivalent energy (or energy average) sound level during a 24-hour day, obtained after addition of ten decibels to sound levels in the night after 10:00 p.m. and before 7:00 a.m. The L_{DN} is generally computed for annual average conditions.

EQUIVALENT SOUND LEVEL (LEQ): The sound level containing the same total energy as a time varying signal over a given sample period. Thus, the LEQ is a single-valued level that expresses the time averaged total energy of a fluctuating sound level. For example, if 64 dB is measured for 10 minutes, 68 dB is measured for 20 minutes and 73 dB is measured for 30 minutes, the 1 hour LEQ is about 71 dB. The LEQ is typically computed over 1, 8 and 24 hour sample periods.

IMPULSIVE NOISE: Noise of short duration, usually less than one second, with an abrupt onset and rapid decay. Examples of impulsive noise include explosions, hammering and discharge of firearms.

NEW DEVELOPMENT: Projects requiring land use or building permits, but excluding remodeling or additions to existing structures. Includes modifications to existing stationary noise sources that increase noise levels.

NOISE LEVEL REDUCTION (NLR): The arithmetic difference between the level of sound outside and inside a structure measured in decibels. For example, if the sound level outside a house is 70 dB and the level inside a room of the house is 45 dB, the NLR is 25 dB ($70-45=25$)

NOISE-SENSITIVE LAND USE:

- a. Residential uses listed in Table O, Framework for Planning of the Land Use Element, except temporary dwellings and residential accessory uses
- b. Schools-preschool to secondary, college and university; specialized education and training
- c. Health care services (hospitals)
- d. Nursing and personal care
- e. Churches
- f. Public assembly and entertainment
- g. Libraries and museums
- h. Hotels and motels
- i. Bed and breakfast facilities
- j. Outdoor sports and recreation
- k. Offices

OUTDOOR ACTIVITY AREAS: The rear yards of dwelling units and other areas which have been designated for outdoor activities and recreation, such as patios, decks, balconies, outdoor eating areas, and swimming pool areas.

STATIONARY NOISE SOURCE: Any fixed or mobile source not preempted from local control by existing federal or state regulations, excluding passenger vehicle movements in parking lots. Examples of such sources include industrial and commercial facilities and vehicle movements on private property (e.g., truck loading and unloading operations in shopping centers, truck terminals, auto race tracks, etc.)

TRANSPORTATION NOISE SOURCE: Traffic on public roadways, railroad line operations and aircraft in flight. Control of noise from these sources is preempted by existing federal or state regulations. However, the effects of noise from transportation sources may be controlled by regulating the location and design of land uses affected by transportation noise sources.

CHAPTER 2: THE NOISE ENVIRONMENT

2.1 Overview of Sources

Based on discussions with county staff and field studies conducted during the preparation of the Noise Element, it was determined that there are a number of potentially significant sources of community noise within San Luis Obispo County. These sources include traffic on state highways and other major roadways; railroad operations; airport operations; military training activities at Camp Roberts; and industrial, commercial and agricultural activities. The Technical Reference Document includes detailed discussions of the noise levels produced by these sources.

2.2 Methods Used to Develop Noise Exposure Information

Analytical noise modeling techniques in conjunction with actual field noise level measurements were used to develop generalized L_{DN} or CNEL contours for major sources of noise within San Luis Obispo County for existing and future conditions.

Analytical noise modeling techniques generally make use of source-specific data, including average levels of activity, hours of operation, seasonal fluctuations, and average levels of noise from source operations. Analytical methods have been developed for many environmental noise sources, including roadways, railroad line operations, railroad yard operations, industrial plants and aircraft/airport operations. Such methods will produce reliable results as long as data inputs and assumptions are valid for the sources being studied. The analytical methods used in the preparation of this Noise Element closely follow recommendations made by the State Office of Noise Control. Methods included the Federal Highway Administration (FHWA) Highway Traffic Noise Prediction Model for roadway sources, the Wyle Laboratories method for determining railroad noise exposure and the Federal Aviation Administration (FAA) Integrated Noise Model (INM) for the assessment of aircraft/airport noise sources. For industrial, commercial and other stationary sources identified for study, a combination of source-specific noise level data and accepted calculation procedures was used to characterize noise emissions based upon operational data obtained from source operations.

The noise exposure information developed during the preparation of the Noise Element does not include all conceivable sources of industrial or commercial noise within the county, but rather is a representative sampling of all conceivable sources. The noise exposure information developed for the sources identified for study should be used only as an indicator of potential noise impacts when other, similar sources are considered.

2.3 Determining Noise Exposure and Mitigation for Specific Locations

The chart shown in Figure 2-1 illustrates where noise exposure information for a particular location may be found. Note that Table 2-1 should be consulted to adjust traffic noise exposure in areas with varying topography. Noise exposure information may be used to determine if a particular land use is consistent with the policies of the Noise Element, and whether or not noise mitigation should be required as a part of the project development process. Figure 2-2 is a flow chart which illustrates the process which should be followed to determine noise exposure and appropriate mitigation for specific locations.

**TABLE 2-1
ADJUSTMENTS TO TRAFFIC NOISE EXPOSURE FOR TOPOGRAPHY**

Topographical Situation	<u>Distance from Center of Roadway</u>		
	<200'	200-400'	>400'
Hillside overlooks roadway	-0-	+1 dB	+3 dB
Roadway is elevated (>15')	-5 dB	-2 dB	-0-
Roadway is cut/below embankment	-5 dB	-5 dB	-5 dB

**FIGURE 2-1
CHART FOR LOCATING NOISE EXPOSURE INFORMATION**

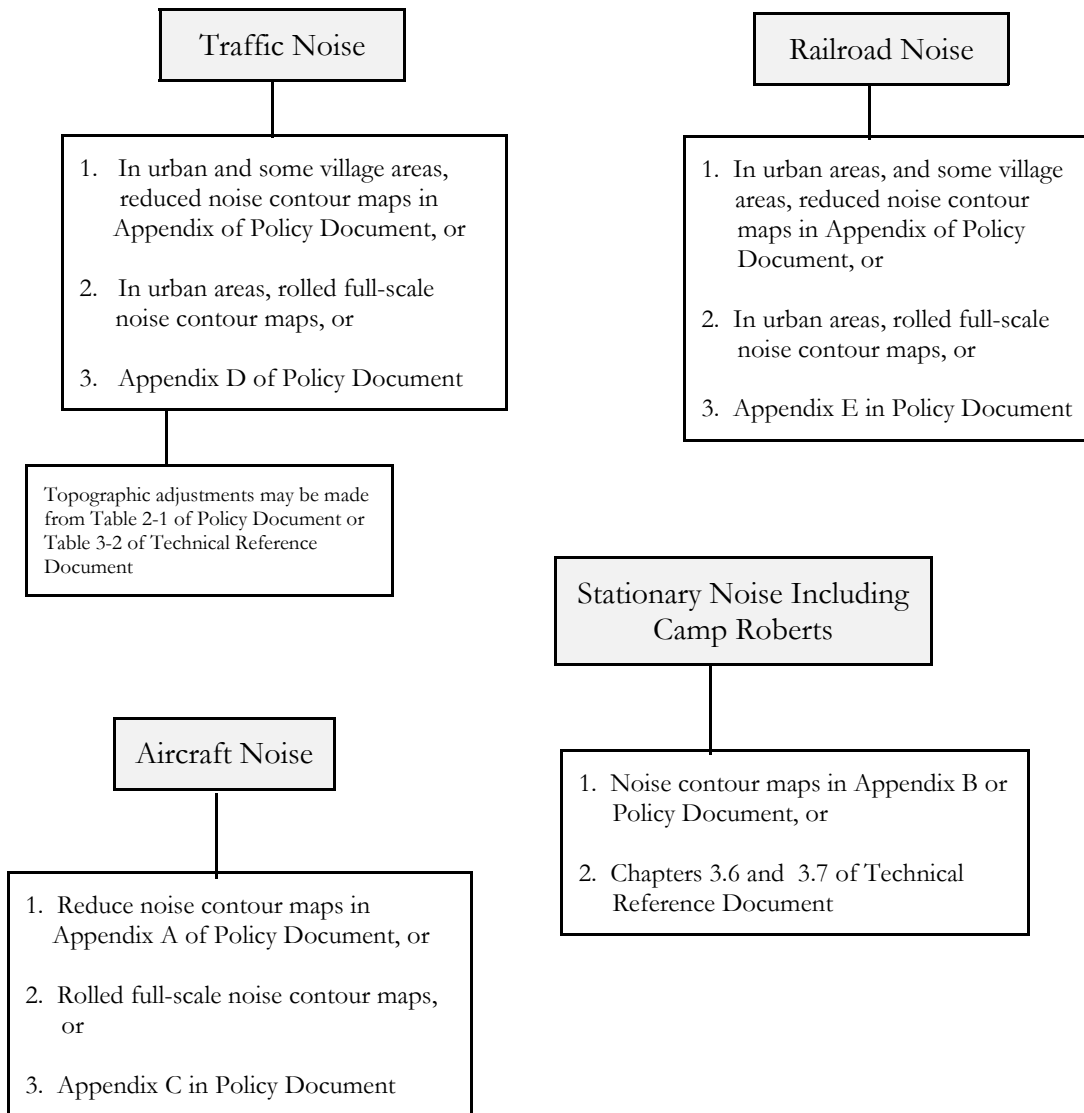

FIGURE 2-2

FLOW CHART FOR DETERMINING NOISE EXPOSURE AND MITIGATION FOR NEW DEVELOPMENT OF NOISE-SENSITIVE USES: MINOR USE PERMITS, SUBDIVISIONS AND DEVELOPMENT PLANS

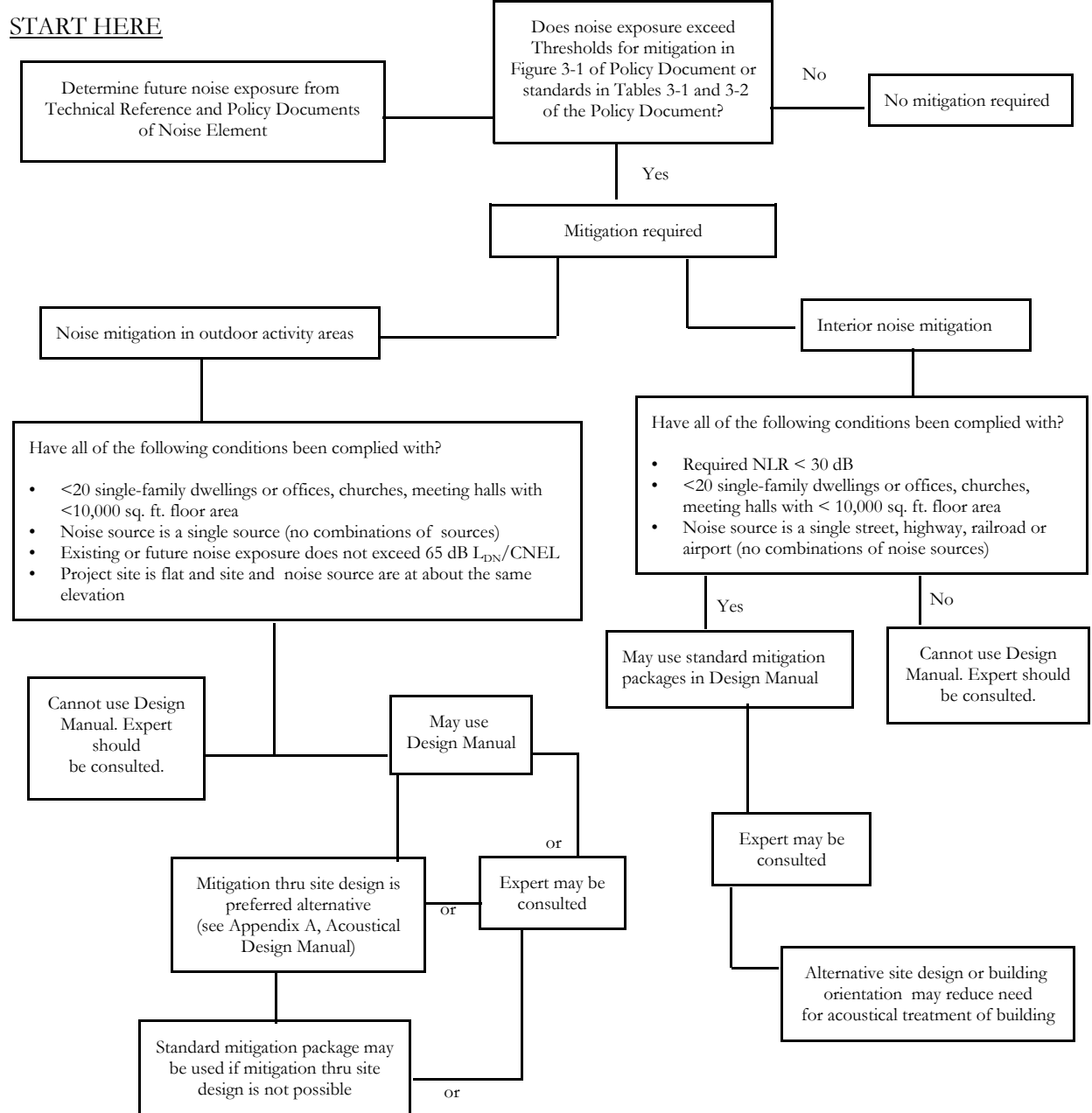

TABLE 2-2

**DETERMINING NOISE MITIGATION FOR NEW DEVELOPMENT OF
NOISE-SENSITIVE USES: PLOT AND SITE PLANS**

A. Is Mitigation Required:

1. Is the proposed use one of the following?
Residential development (except temporary dwellings), school, hospital, nursing and personal care, church, public assembly and entertainment, libraries and museums, hotels and motels, bed and breakfast facilities, outdoor sports and recreation, offices.

If yes, go to #2; if no, NO MITIGATION REQUIRED

2. Is future noise exposure at the noise-sensitive use or outside activity area (from maps or table in Policy Document, Appendices A, B, C, D, or E) above 60dB LDN/CNEL for transportation noise sources or above the standards in Table 3-2 of the Policy Document?

If yes, go to #3; if no, NO MITIGATION REQUIRED

3. For traffic noise, is future noise exposure between 60 and 65 Db LDN and roadway is either a) below grade in a cut/embankment or b) elevated more than 15 feet above and within 200 feet of proposed noise-sensitive use, including outdoor activity area?

If no, go to #4; if yes, NO MITIGATION REQUIRED

4. Has an acoustical analysis prepared by an expert been submitted at the option of the applicant which demonstrates that no mitigation is needed?

If no, MITIGATION REQUIRED, go to B; if yes, NO MITIGATION REQUIRED

B. Is Mitigation to be Accomplished by Following the Recommendations of an Acoustical Analysis Prepared by an Expert?

If the answer to any one of the following is yes, then implementation of the recommendations of an acoustical analysis prepared by an expert is required. If not, an acoustical analysis may be submitted at the option of the applicant or go to C.

1. Is the proposed use other than single-family residential, office, church, or meeting hall?
2. Is the noise source a stationary source?
3. Is the proposed use affected by more than one noise source?

4. Is the future noise exposure either a) greater than 75 dB $L_{DN}/CNEL$ at the office, church or meeting hall, b) greater than 65 dB $L_{DN}/CNEL$ at the single-family residence, or c) greater than 65 dB $L_{DN}/CNEL$ in any outdoor activity area?
5. Is the outdoor activity area sloped or not at approximately the same grade as the noise source (with the exception of aircraft noise)?

C. Standardized Mitigation Packages

The following or a suitable alternative approved by the Building Official shall be required when the future noise exposure is as shown.

Interior Mitigation

1. 60 - 65 dB $L_{DN}/CNEL$
 - a. Air conditioning or a mechanical ventilation system
 - b. Windows and sliding glass doors mounted in low air infiltration rate frames (0.5 cfm or less, per ANSI specifications)
 - c. Solid core exterior doors with perimeter weather stripping and threshold seals
2. 65 - 70 dB $L_{DN}/CNEL$
 - a. Same as No. 1a-c.
 - b. Exterior walls consist of stucco or brick veneer. Wood siding with a 1/2" minimum thickness fiberboard ("soundboard") underlayer may also be used.
 - c. Glass in both windows and doors should not exceed 20% of the floor area in a room.
 - d. Roof or attic vents facing the noise source should be baffled (see Appendix C in Acoustical Design Manual for an example of a suitable vent treatment).
 - e. For aircraft noise exposure, same as a-d plus:
 - 1) Fireplaces should be fitted with tight-fitting dampers and glass doors.
 - 2) Solid sheeting with a minimum thickness of 1/2" should underlay roofing materials.
 - 3) Skylights should not be allowed in occupied rooms.

3. 70-75 dB L_{DN}/CNEL
 - a. Same as No. 2a-e
 - b. The interior sheetrock of exterior wall assemblies should be attached to studs by resilient channels. Staggered studs or double walls are acceptable alternatives.
 - c. Window assemblies should have a laboratory-tested STC rating of 30 or greater. (Windows that provide superior noise reduction capability and that are laboratory-tested are sometimes called "sound-rated" windows. In general, these windows have thicker glass and/or increased air space between panes. In contrast, standard energy-conservation double-pane glazing with a 1/8" or 1/4" air space may be less effective in reducing noise from some noise sources than single-pane glazing).
 - d. For aircraft noise exposure, same as 3a-c plus:
 - 1) Fireplaces should not be allowed.
 - 2) Solid sheeting with a minimum thickness of 1/2" should underlay roofing materials.
 - 3) Ceilings should be attached to joists by resilient channels.
 - 4) Skylights should not be allowed in occupied rooms.

Mitigation for Outside Activity Areas

1. If any building is located between the noise source and the outdoor activity area such that it shields the outdoor activity area, NO MITIGATION IS REQUIRED. Otherwise, go to #2.
2. For traffic and railroad noise, construct a barrier of sufficient height to interrupt line-of-sight between the noise source and the receiver, as described in the Acoustical Design Manual.
3. For aircraft noise, NO MITIGATION REQUIRED.

2.4 Community Noise Survey

A community noise survey was conducted in San Luis Obispo County during August 1990 to document background noise levels in areas where noise-sensitive land uses are located. Results of the community noise survey indicate that existing background noise levels in many areas of the county that contain noise-sensitive land uses are relatively quiet. To preserve quiet conditions, noise level standards and policies (see Chapter 3) have been adopted which will prevent degradation of the existing noise environment as much as possible. A more detailed discussion of the community noise survey may be found in the Technical Reference Document.

CHAPTER 3: GOALS AND POLICIES

3.1 Goals

The goals of the San Luis Obispo County Noise Element are:

1. To protect the residents of San Luis Obispo County from the harmful and annoying effects of exposure to excessive noise.
2. To protect the economic base of San Luis Obispo county by preventing incompatible land uses from encroaching upon existing or planned noise-producing uses.
3. To preserve the tranquility of residential areas by preventing the encroachment of noise-producing uses.
4. To educate the residents of San Luis Obispo County concerning the effects of exposure to excessive noise and the methods available for minimizing such exposure.
5. To avoid or reduce noise impacts through site planning and project design, giving second preference to the use of noise barriers and/or structural modifications to buildings containing noise-sensitive land uses.

3.2 Land Use Compatibility - Transportation

Figure 3-1 shows the ranges of noise exposure from transportation noise sources which are considered to be acceptable, conditionally acceptable, or unacceptable for the development of different land uses. Figure 3-1 is used to determine whether mitigation is needed for development of land uses near major transportation noise sources. In areas where the noise environment is acceptable, new development may be permitted without requiring noise mitigation. For areas where the noise environment is conditionally acceptable, new development should be allowed only after noise mitigation has been incorporated into the design of the project to reduce noise exposure to the levels specified by the policies listed in Section 3.3. For areas where the noise environment is unacceptable, new development in compliance with the policies of Section 3.3 is usually not feasible.

FIGURE 3-1

**LAND USE COMPATIBILITY FOR NEW DEVELOPMENT
NEAR TRANSPORTATION NOISE SOURCES***

LAND USE	EXTERIOR NOISE EXPOSURE					
	LDN or CNEL, dB					
	55	60	65	70	75	80
Residential (except temp. dwellings & Res acc. uses), Pub Assembly & Entertainment (except meeting halls)	██████████		██████████		~~~~~	~~~~~
Bed and Breakfast Facilities, Hotels and Motels	██████████		██████████		~~~~~	~~~~~
Schools - Preschool to Secondary, College and University, Specialized Education and Training; Libraries and Museums, Hospitals, Nursing and Personal Care, Meeting Halls, Churches	██████████		██████████		~~~~~	~~~~~
Outdoor Sports and Recreation	██████████	██████████		██████████	~~~~~	~~~~~
Offices	██████████		██████████		~~~~~	~~~~~

* This figure indicates whether mitigation is required. See Table 3-1 for Noise Standard.

INTERPRETATION

ACCEPTABLE
 (no mitigation required)

Specified land use is satisfactory.

CONDITIONALLY ACCEPTABLE
 (mitigation required)

Use should be permitted only after careful study and inclusion of mitigation measures as needed to satisfy policies of the Noise Element.

UNACCEPTABLE
 (mitigation may not be feasible)

Development is usually not feasible in accordance with the goals of the Noise Element.

3.3 Policies

The following specific policies are adopted by San Luis Obispo County to accomplish the goals of the Noise Element:

General:

Policy 3.3.1 The noise standards in this chapter represent maximum acceptable noise levels. New development should minimize noise exposure and noise generation.

Transportation Noise Sources:

Policy 3.3.2 New development of noise-sensitive land uses (see Section 1.5 – Definitions) shall not be permitted in areas exposed to existing or projected future levels of noise from transportation noise sources which exceed 60 dB L_{DN} or CNEL (70 L_{DN} or CNEL for outdoor sports and recreation) unless the project design includes effective mitigation measures to reduce noise in outdoor activity areas and interior spaces to or below the levels specified for the given land use in Table 3-1.

Policy 3.3.3 Noise created by new transportation noise sources, including roadway improvement projects, shall be mitigated so as not to exceed the levels specified in Table 3-1 within the outdoor activity areas or interior spaces of existing noise sensitive land uses.

Stationary Noise Sources:

Policy 3.3.4 New development of noise-sensitive land uses shall not be permitted where the noise level due to existing stationary noise sources will exceed the noise level standards of Table 3-2, unless effective noise mitigation measures have been incorporated into the design of the development to reduce noise exposure to or below the levels specified in Table 3-2.

Policy 3.3.5 Noise created by new proposed stationary noise sources or existing stationary noise sources which undergo modifications that may increase noise levels shall be mitigated as follows and shall be the responsibility of the developer of the stationary noise source:

- a) Noise from agricultural operations conducted in accordance with accepted standards and practices is not required to be mitigated.
- b) Noise levels shall be reduced to or below the noise level standards in Table 3-2 where the stationary noise source will expose an existing noise-sensitive land use (which is listed in the Land Use element as an allowable use within its existing land use category) to noise levels which exceed the standards in Table 3-2. When the affected noise-sensitive land use is Outdoor Sports and Recreation, the noise level standards in Table 3-2 shall be increased by 10 Db.

Where the noise source is one of the following electrical substations which is not modified so as to increase noise levels, the noise standards shall instead be fifty

dB between 10 p.m. and 7 a.m. and fifty-five dB between 7 a.m. and 10 p.m., determined at the property line of the receiving land use: the Cholame, San Miguel, Templeton, Cambria, Perry, Cayucos, Baywood, Highway 1 between Morro Bay and the California Men's Colony, Goldtree, Foothill, San Luis Obispo, Oceano, Mesa, Union Oil, Callender, and Mustang electrical substations.

- c) Noise levels shall be reduced to or below the noise level standards in Table 3-2 where the stationary noise source will expose vacant land in the Agriculture, Rural Lands, Residential rural, Residential Suburban, Residential Single-Family, Residential Multi-Family, Recreation, Office and Professional, and Commercial Retail land use categories to noise levels which exceed the standards in Table 3-2.

Where the noise source is one of the following electrical substations which is not modified so as to increase noise levels, the noise standards shall instead be fifty dB between 10 p.m. and 7 a.m. and fifty-five dB between 7 a.m. and 10 p.m., determined at the property line of the receiving land use: the Cholame, San Miguel, Templeton, Cambria, Perry, Cayucos, Baywood, Highway 1 between Morro Bay and the California Men's Colony, Goldtree, Foothill, San Luis Obispo, Oceano, Mesa, Union Oil, Callender, and Mustang electrical substations.

This policy may be waived when the Director of Planning and Building determines that such vacant land is not likely to be developed with a noise sensitive land use.

- d) For new proposed resource extraction, manufacturing or processing noise sources or modifications to those sources which increase noise levels: where such noise sources will expose existing noise-sensitive land uses (which are listed in the Land Use Element as allowable uses within their land use categories) to noise levels which exceed the standards in Table 3-2, best available control technologies shall be used to minimize noise levels. The noise levels shall in no case exceed the noise level standards in Table 3-2.

Existing and Cumulative Noise Impacts:

Policy 3.3.6 San Luis Obispo County shall consider implementing mitigation measures where existing noise levels produce significant noise impacts to noise-sensitive land uses or where new development may result in cumulative increases of noise upon noise-sensitive land uses.

TABLE 3-1

MAXIMUM ALLOWABLE NOISE EXPOSURE-TRANSPORTATION NOISE SOURCES

Land Use	<u>Outdoor Activity Areas¹</u>	<u>Interior Spaces</u>	
	$L_{DN}/CNEL, \text{dB}$	$L_{DN}/CNEL, \text{dB}$	L_{eq}, dB^2
Residential (except temporary dwellings and res accessory uses)	60 ³	45	--
Bed and Breakfast Facilities, Hotels and Motels	60 ³	45	--
Hospitals, Nursing and Personal Care	60 ³	45	--
Public Assembly and Entertainment (except Meeting Halls)	--	--	35
Offices	60 ³	--	45
Churches, Meeting Halls	--	--	45
Schools-Preschool to Secondary, College and University, Specialized Education and Training Libraries and Museums	--	--	45
Outdoor Sports and Recreation	70	--	--

¹ Where the location of outdoor activity areas is unknown, the exterior noise level standard shall be applied to the property line of the receiving land use.

² As determined for a typical worst-case hour during periods of use.

³ For other than residential uses, where an outdoor activity area is not proposed, the standard shall not apply. Where it is not possible to reduce noise in outdoor activity areas to 60 dB $L_{DN}/CNEL$ may be allowed provided that available exterior noise level reduction measures have been implemented and interior noise levels are in compliance with this table.

TABLE 3-2

MAXIMUM ALLOWABLE NOISE EXPOSURE-STATIONARY NOISE SOURCES¹

	Daytime (7 a.m. to 10 p.m.)	Nighttime ² (10 p.m. to 7 a.m.)
Hourly L_{eq} , dB	50	45
Maximum level, dB	70	65
Maximum level, dB-Impulsive Noise	65	60

¹ As determined at the property line of the receiving land use. When determining the effectiveness of noise mitigation measures, the standards may be applied on the receptor side of noise barriers or other property line noise mitigation measures.

² Applies only where the receiving land use operates or is occupied during nighttime hours.

CHAPTER 4: IMPLEMENTATION MEASURES

To achieve compliance with the policies of the Noise Element, San Luis Obispo County shall undertake the following implementation program. The implementation program focuses on preventing new noise-related land use conflicts by requiring that new development be reviewed to determine whether it complies with the policies in Chapter 3. If mitigation of noise impacts is necessary, it shall be achieved by a) carrying out an acoustical analysis meeting the requirements of Table 4-1, or b) implementing the standard noise mitigation packages contained in the Acoustical Design Manual where conditions in the following section 4.3 are met.

The noise exposure maps in this document, the information concerning the effects of noise on people in the Technical Reference Document and techniques for noise control described in the Acoustical Design Manual are used in reviewing the noise effects of new development. The Acoustical Design Manual describes standard noise mitigation packages which may be used to reduce noise exposure inside buildings and within outdoor activity areas by specified amounts. This document contains noise exposure maps that are intended to be used as a screening device to determine when a proposed development may be exposed to excessive noise levels which require mitigation. The noise exposure maps can also assist in long range planning. Generally, the noise exposure maps provide a conservative (worst-case) assessment of noise exposure for the major noise sources identified for study. It is probable that other major noise sources, especially stationary sources, will be identified during the project review process, since only a representative sample of stationary sources was evaluated during the preparation of this document.

The Technical Reference Document and Acoustical Design Manual should be used to help determine whether or not proposed noise mitigation measures are reasonable and effective. Control of noise at the source and through the thoughtful location and orientation of receiving uses should be given preference over the control of noise along the path of transmission through the use of noise barriers or the acoustical treatment of buildings.

The following implementation measures shall be used by San Luis Obispo County. A schedule for carrying out these implementation measures is shown in Table 4-1.

- 4.1 New public and private development proposals shall be reviewed to determine conformance with the policies of this Noise Element.
- 4.2 When mitigation must be applied to satisfy the policies in Chapter 3.3, the following mitigation measures shall be considered and preference shall be given where feasible to the measures in following item a:
 - a) Site layout, including setbacks, open space separation and shielding of noise-sensitive uses with non-noise-sensitive uses.
 - b) Acoustical treatment of buildings.
 - c) Structural measures: construction of earthen berms or wood or concrete barriers.

- 4.3 When mitigation of railroad noise is needed to satisfy the policies in Chapter 3.3, emphasis should be given to shielding noise-sensitive uses with non-noise-sensitive uses such as garages and to orienting the quiet areas of houses such as bedrooms and living rooms away from the noise source. The purpose of this measure is to minimize exposure to the high noise levels caused by train passbys while at the same time avoiding the often monotonous and costly construction of noise barriers.
- 4.4 Where development subject to discretionary approval may result in land uses being exposed to existing or projected future noise levels exceeding the levels specified by the policies in Chapter 3.3, an acoustical analysis shall be required at the time the application is accepted for processing. In those cases, noise mitigation measures should be included in the project design as appropriate. For development not subject to discretionary approval and/or environmental review, the requirements for an acoustical analysis shall be implemented prior to the issuance of a building permit. The requirements for the content of an acoustical analysis are given in Table 4-1. At the discretion of the county, the requirement for an acoustical analysis may be waived provided that all of the following conditions are met:

Outdoor Activity Areas

- a) The development is for less than 20 single-family dwellings or for office buildings, churches or meeting halls having a total gross floor area less than 10,000 square feet.
- b) The noise source in question consists of a single roadway or railway for which up-to-date noise exposure information is available. An acoustical analysis will be required when the noise source in question is a stationary noise source or when the noise source consists of multiple transportation noise sources.
- c) The existing or projected future noise exposure at the exterior of buildings which will contain noise-sensitive uses or within proposed outdoor activity areas (other than outdoor sports and recreation uses) does not exceed 65 dB L_{DN} (or CNEL) prior to mitigation. For outdoor sports and recreation uses, the existing or projected future noise exposure may not exceed 75 dB L_{DN} (or CNEL) prior to mitigation.
- d) The topography in the project area is flat, and the noise source and receiving land use are at the same grade.

Interior Spaces

- a) Required Noise Level Reduction (NLR) is equal to or less than 30 dB.
- b) The development is for less than 20 single-family dwellings or for offices, churches, meeting halls with less than 10,000 sq. ft. floor area.
- c) The noise source in question consists of a single roadway, railway or airport for which up-to-date noise exposure information is available. An acoustical analysis will be required when the noise source is a stationary noise source or consists of multiple transportation noise sources.

General

Effective noise mitigation, as determined by the county, is incorporated into the project design to reduce noise exposure to the levels specified in Table 3-1. Such measures may include the use of building setbacks, building orientation, noise barriers and the standard noise mitigation packages contained within the Acoustical Design Manual. If closed windows are required for compliance with interior noise level standards, air conditioning or a mechanical ventilation system will be required.

- 4.5 Where mitigation in accordance with the policies and standards of this Noise Element is not feasible, the review authority may adjust or waive such policies and standards the minimum amount necessary to enable reasonable use of the property, provided that noise levels are then mitigated to the maximum extent feasible. The decision of the review authority may be appealed to the Board of Supervisors.
- 4.6 If the Planning Director determines that a noise-sensitive land use may be exposed to noise levels that exceed the standards in Chapter 3.3, notwithstanding the noise contour information in this Noise Element, an acoustical analysis meeting the requirements in Table 4-1 may be required. An example of where this may apply is in areas not shown on the noise contour maps of this Noise Element where the combined impact of two or more noise sources may exceed the standards in Chapter 3.3.
- 4.7 Procedures shall be developed and employed to ensure that noise mitigation measures required pursuant to an acoustical analysis are implemented in the development review and building permit processes.
- 4.8 Procedures shall be developed and employed to monitor compliance with the policies of the Noise Element after completion of projects requiring noise mitigation.
- 4.9 The State Noise Insulation Standards (California Code of Regulations, Title 24) and Chapter 35 of the Uniform Building Code (UBC) shall be enforced.
- 4.10 The California Highway Patrol, the County Sheriff and local police departments shall be asked to actively enforce the California Vehicle Code section relating to adequate vehicle mufflers and modified exhaust systems.
- 4.11 New equipment and vehicles shall be purchased by the county only if they comply with noise level performance standards based upon the best available noise reduction technology. Alternatives to the use of existing noisy equipment, such as leaf blowers, shall be pursued.
- 4.12 The Noise Element shall be periodically reviewed and updated to ensure that noise exposure information and specific policies are consistent with changing conditions within the county and with noise control regulations or policies enacted after the adoption of this element. After new noise exposure maps for the Paso Robles Municipal Airport are published and after the U.S. Army completes its aircraft noise evaluation for Camp Roberts, the maps and findings of those studies should be incorporated by reference into this Noise Element.

- 4.13** The Acoustical Design Manual shall be made available to the public so that noise reduction measures can be incorporated into private projects consistent with the goals and policies of this Noise Element.
- 4.14** One or more of the following mitigation measures shall be considered where existing noise levels significantly impact existing noise-sensitive land uses or where cumulative increases in noise levels resulting from new development significantly impact noise-sensitive land uses:
- a. Rerouting traffic onto streets that have low traffic volumes or onto streets that do not adjoin noise-sensitive land uses.
 - b. Rerouting trucks onto streets that do not adjoin noise-sensitive land uses.
 - c. Construction of noise barriers.
 - d. Lowering speed limits.
 - e. Acoustical treatment of buildings.
 - f. Programs to pay for noise mitigation such as low cost loans to owners of noise-impacted property or establishment of developer fees.
- 4.15** The county shall encourage alternative means of transportation such as car-pooling, walking, bicycling, and transit in order to reduce traffic and associated noise exposure.

TABLE 4-1

SCHEDULE FOR CARRYING OUT NOISE ELEMENT IMPLEMENTATION MEASURES

IMPLEMENTATION MEASURE	RESPONSIBLE AGENCY	POTENTIAL FUNDING	PRIORITY	TIME FRAME
4.1- Review of Development	County Planning	No Increase	High	Ongoing
4.2- Mitigation Measures	County Planning	No Increase	High	Ongoing
4.4- Acoustical Analyses	Project Applicant, Review by County Planning	No Increase (Proj. Applicant)	High	Ongoing
4.5- Waiver of Standards	Board of Supervisors	No Increase	High	Ongoing
4.6- Planning Director Discretion	County Planning	No Increase	High	Ongoing
4.7- Noise Mitigation	County Planning	Developer Fee, General Fund	High	Ongoing
4.8- Noise Mitigation Compliance	County Planning	Developer Fee, General Fund	High	Ongoing
4.9- Enforcement of State & UBC Noise Standards	County Planning	No Increase	High	Ongoing
4.10- Vehicle Code Enforcement	Hwy Patrol, Sheriff, Police Department	No Increase	Moderate	Ongoing
4.11- Purchase of New Equipment	County General Services	General Fund	Moderate	Ongoing
4.12- Noise Element Update	County Planning	General Fund	High	Periodically
4.13- Acoustical Design Manual	County Planning	No Increase	High	Ongoing
4.14- Mitigation of Existing Community Noise	County Engineering, Planning	General Fund, Developer Fees	Moderate	Ongoing

**TABLE 4-2
REQUIREMENTS FOR AN ACOUSTICAL ANALYSIS**

An acoustical analysis prepared pursuant to the Noise Element Shall:

- A. Be the financial responsibility of the applicant.
- B. Be prepared by a qualified person experienced in the fields of environmental noise assessment and architectural acoustics.
- C. Include representative noise level measurements with sufficient sampling periods and locations to adequately describe local conditions. Where actual field measurements cannot be conducted, all sources of information used for calculation purposes shall be fully described. When the use being studied is a commercial or industrial use, all noise sources related to the operation, service, and maintenance of the facility shall be considered, including but not limited to the following: parking lot and landscape maintenance, refuse collection and truck loading/unloading activities, amplified sound, and outdoor sales and activities.
- D. Estimate existing and projected (20 years) noise levels in terms of the descriptors used in Tables 3-1 and 3-2 and compare those levels to the policies of the Noise Element. Projected future noise levels shall take into account noise from planned streets, highways and road connections.
- E. Recommend appropriate mitigation to meet or exceed the policies and standards of the Noise Element, giving preference to proper site planning and design over mitigation measures which require the construction of noise barriers or structural modifications to buildings which contain noise-sensitive land uses.
- F. Estimate noise exposure after the prescribed mitigation measures have been implemented.
- G. Describe a post-project assessment program which could be used to evaluate the effectiveness of the proposed mitigation measures.

**APPENDIX A: NOISE CONTOUR MAPS -
TRANSPORTATION NOISE
SOURCES (2010)**

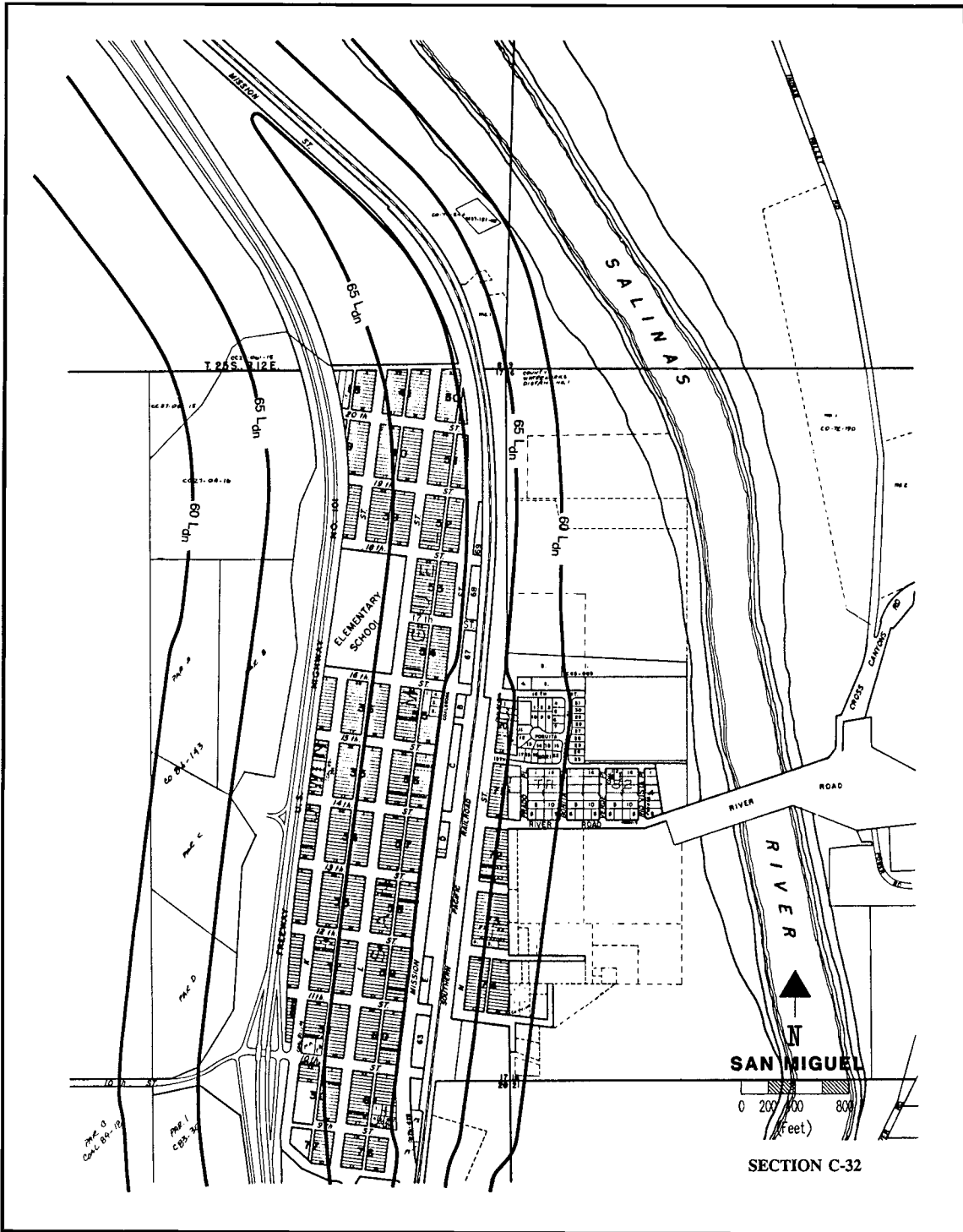

NOISE ELEMENT ■ NOISE CONTOUR MAP

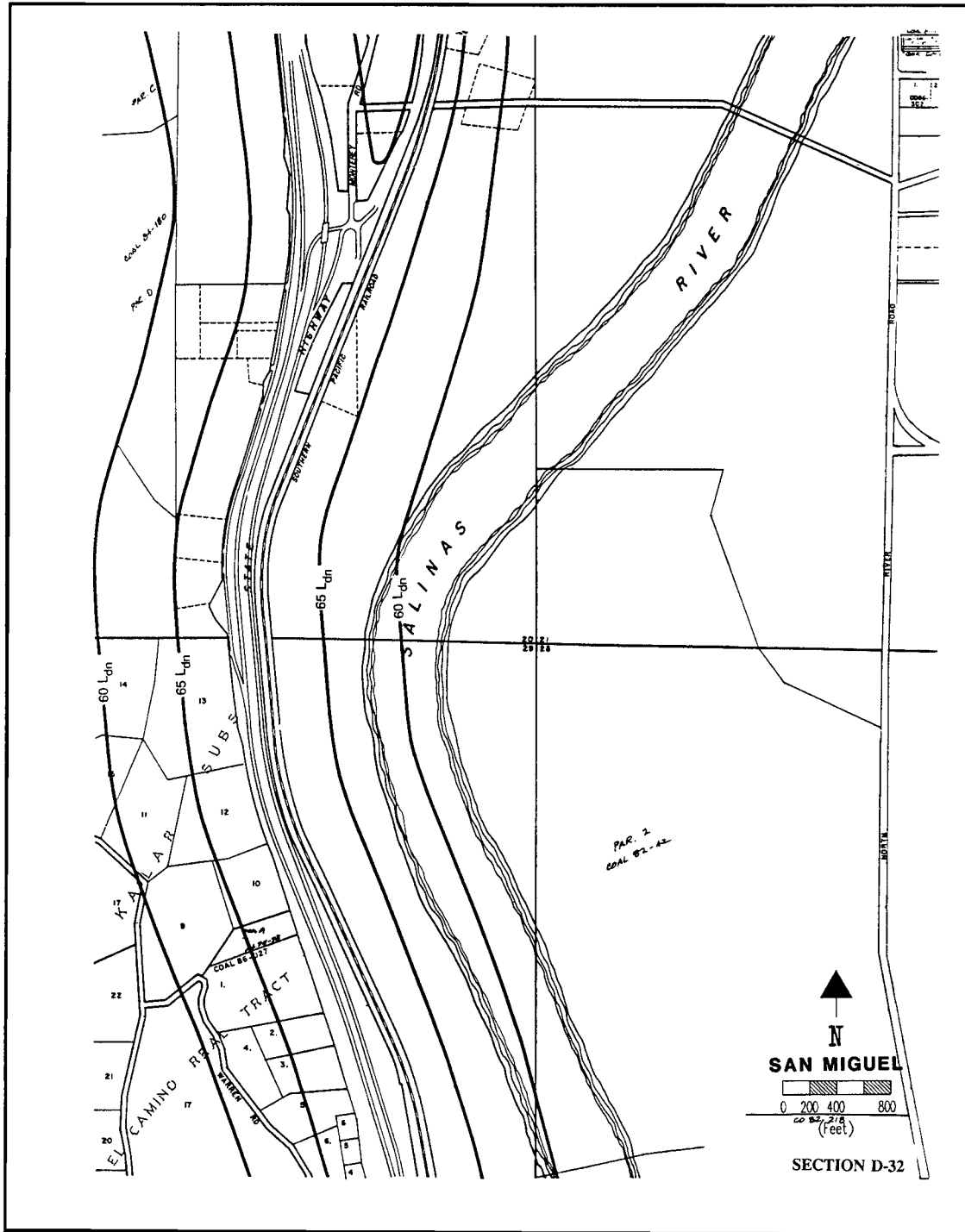

NOISE ELEMENT ■ NOISE CONTOUR MAP

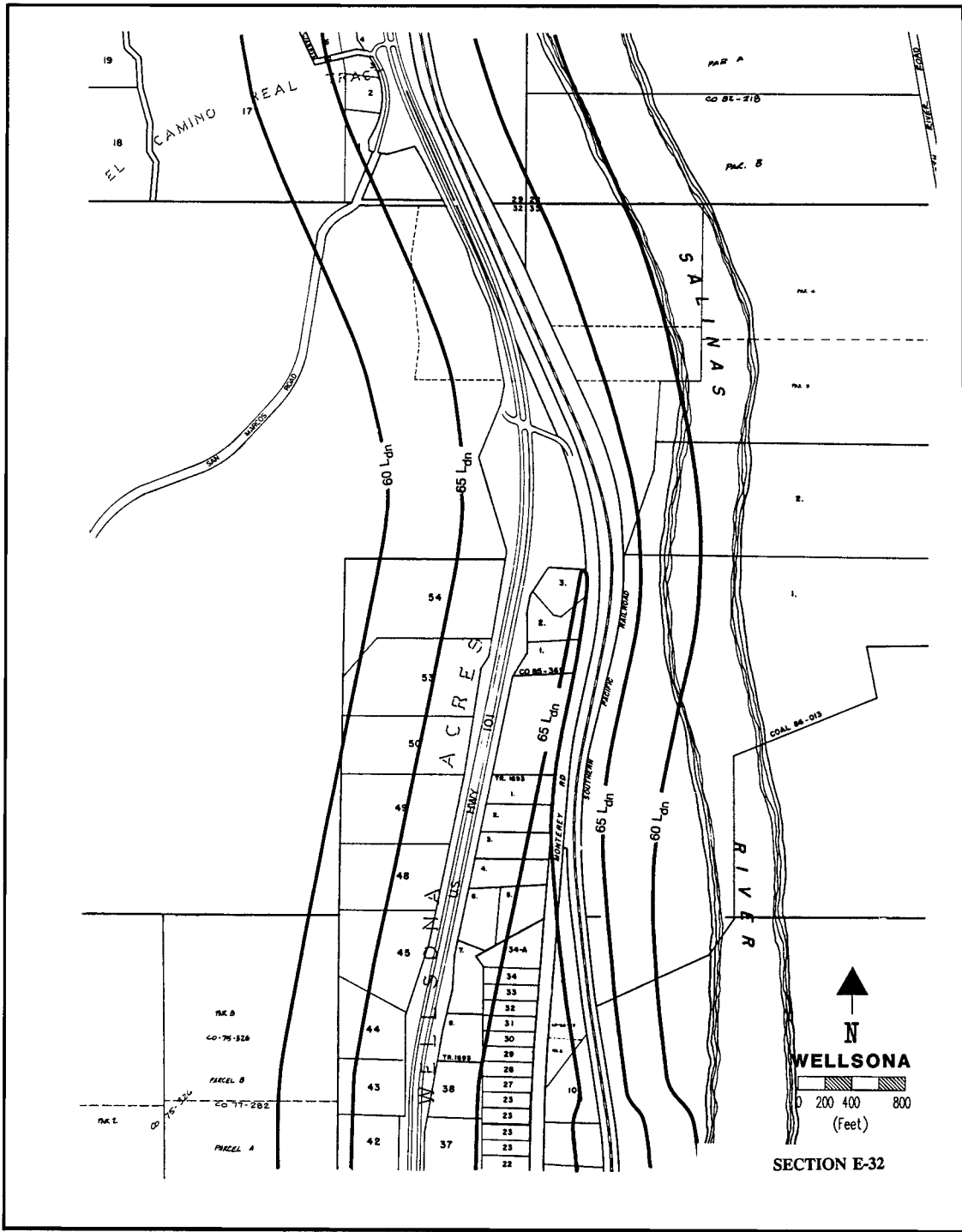

NOISE ELEMENT ■ NOISE CONTOUR MAP

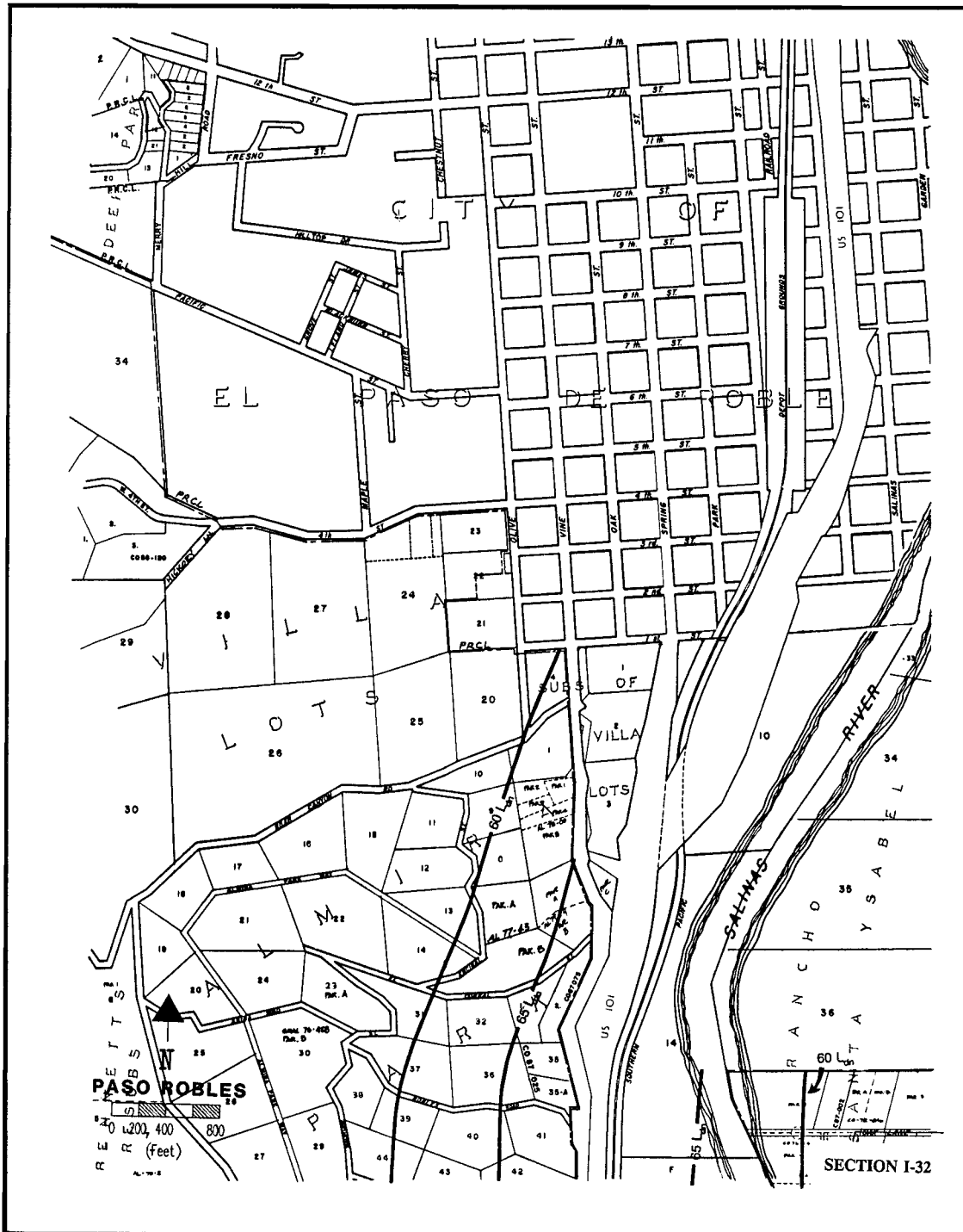

NOISE ELEMENT ■ NOISE CONTOUR MAP

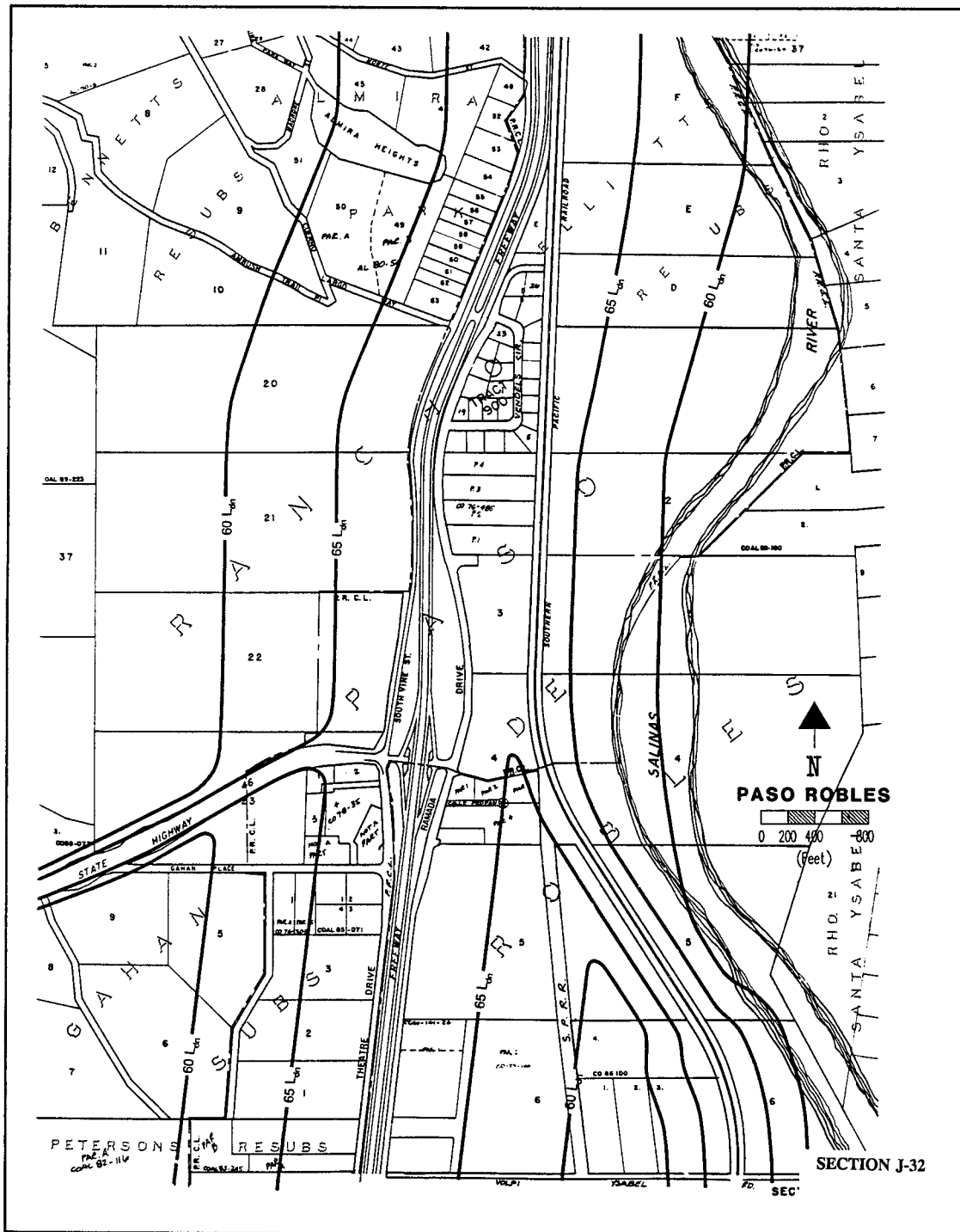

NOISE ELEMENT ■ NOISE CONTOUR MAP

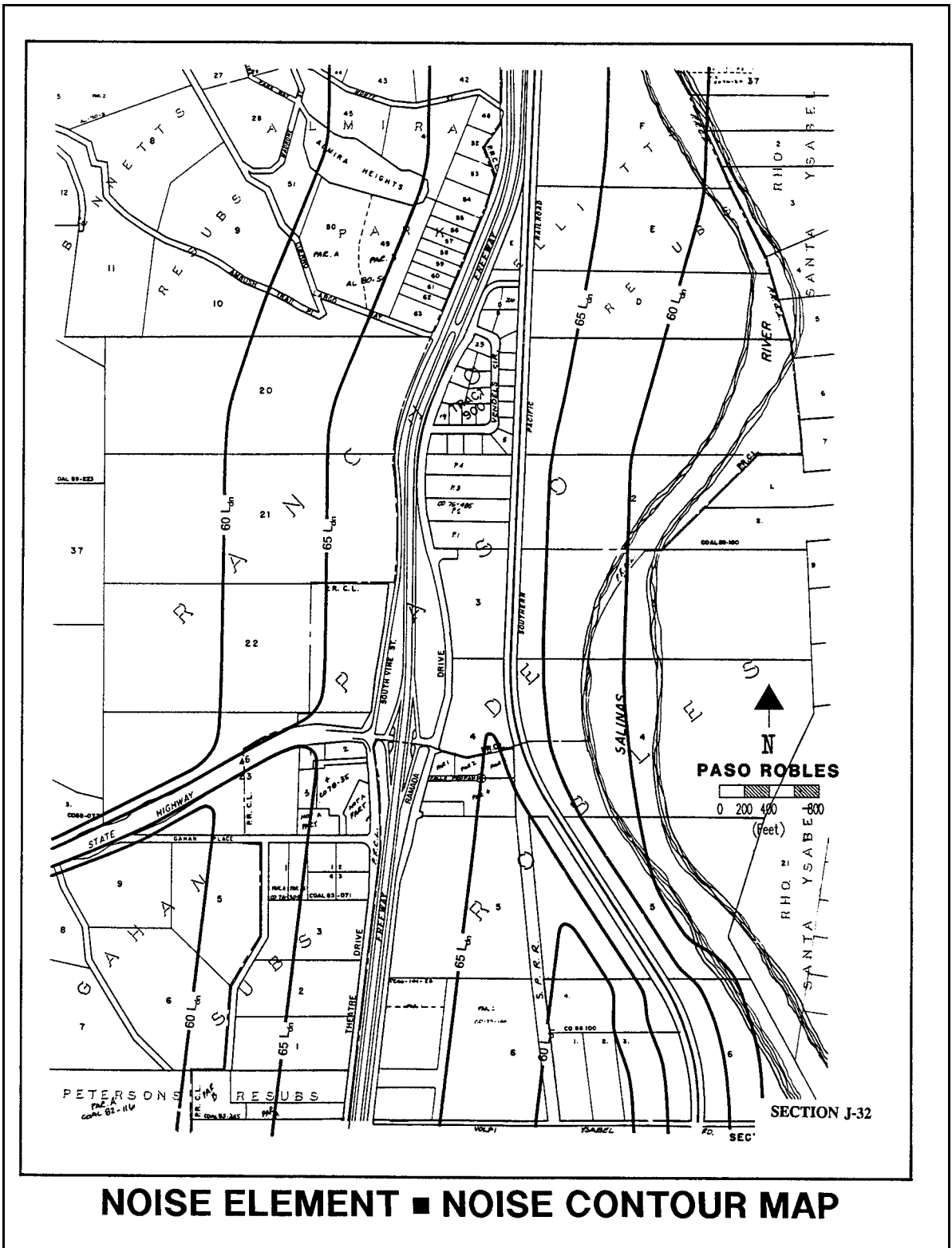

NOISE ELEMENT ■ NOISE CONTOUR MAP

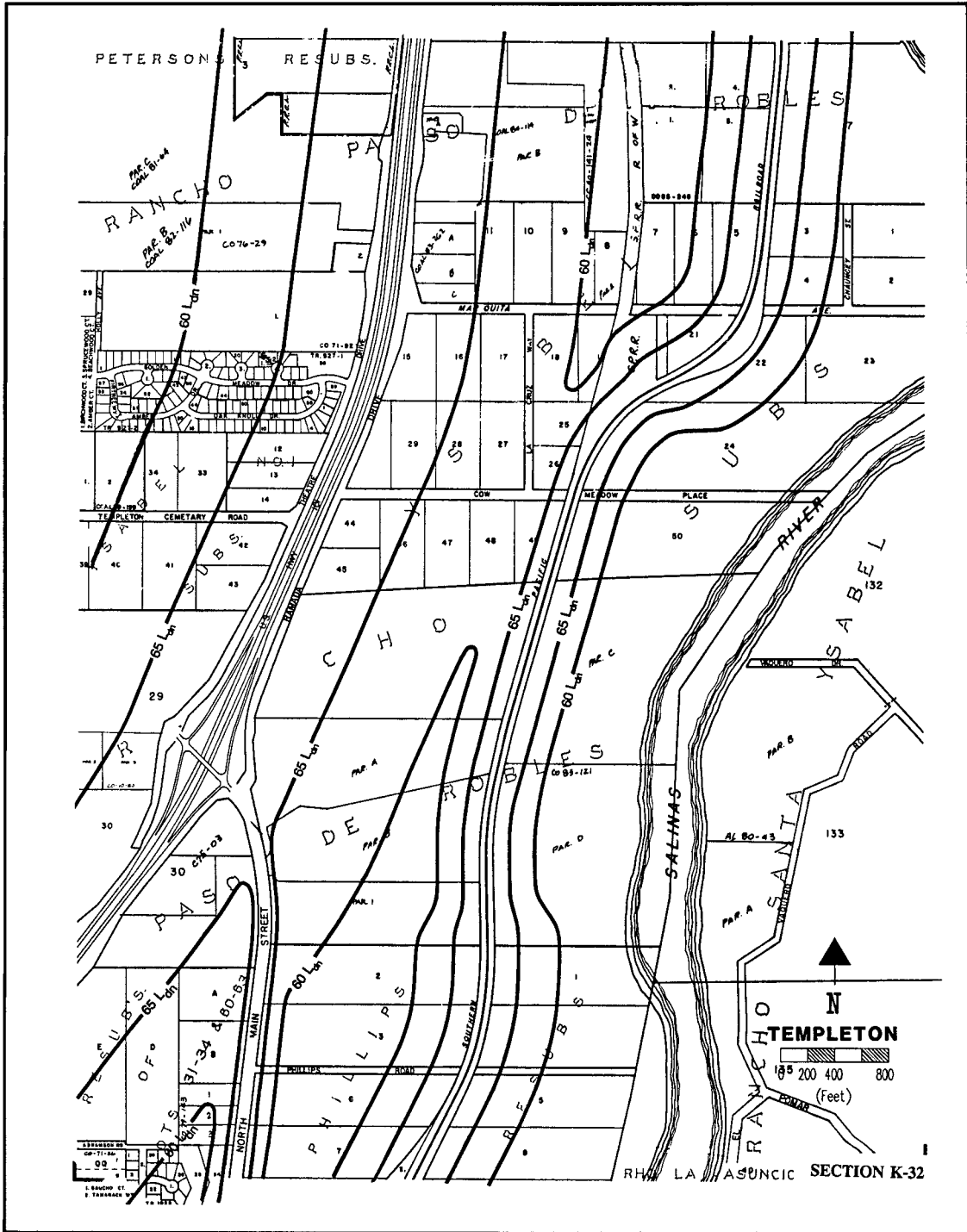

NOISE ELEMENT ■ NOISE CONTOUR MAP

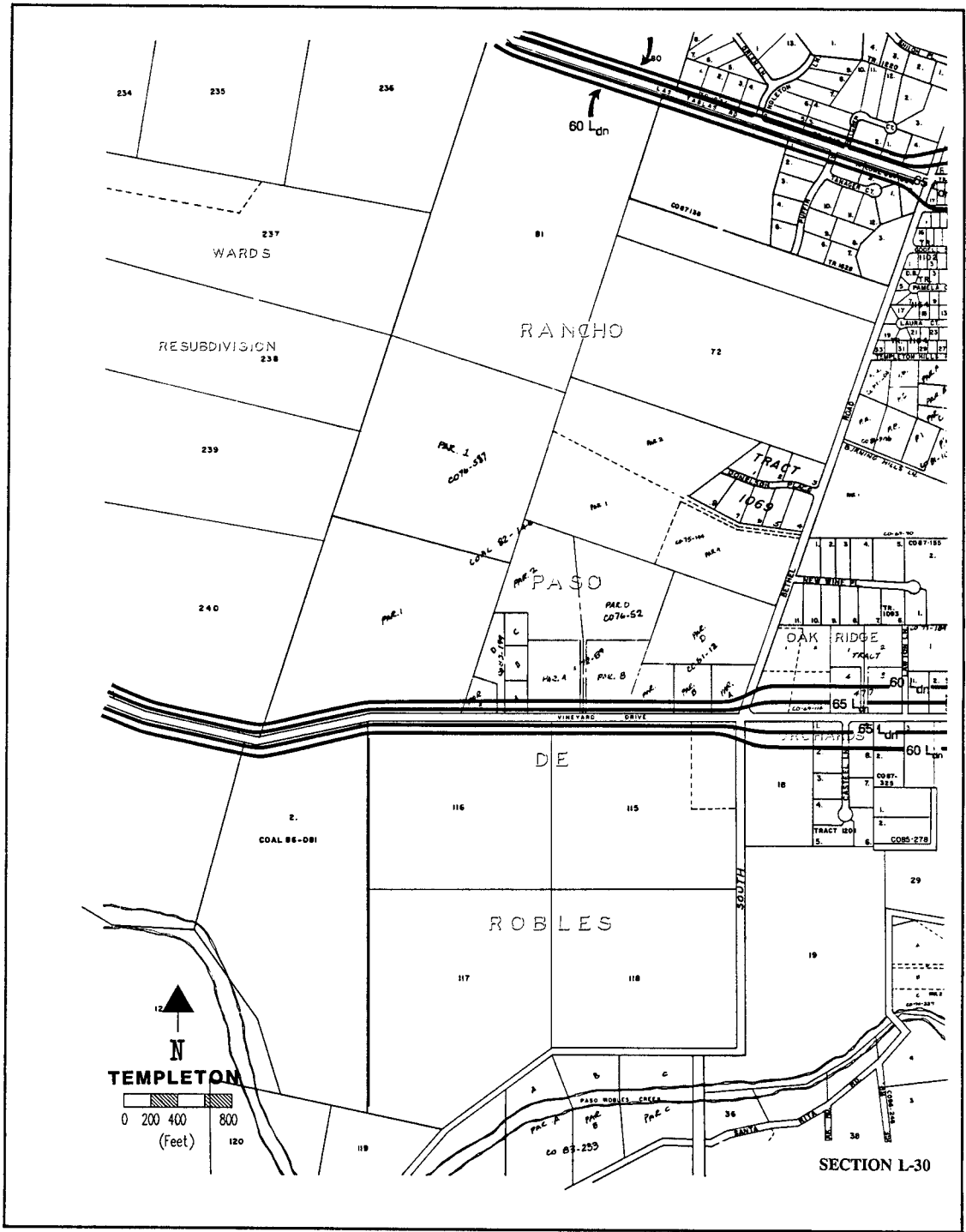

NOISE ELEMENT ■ NOISE CONTOUR MAP

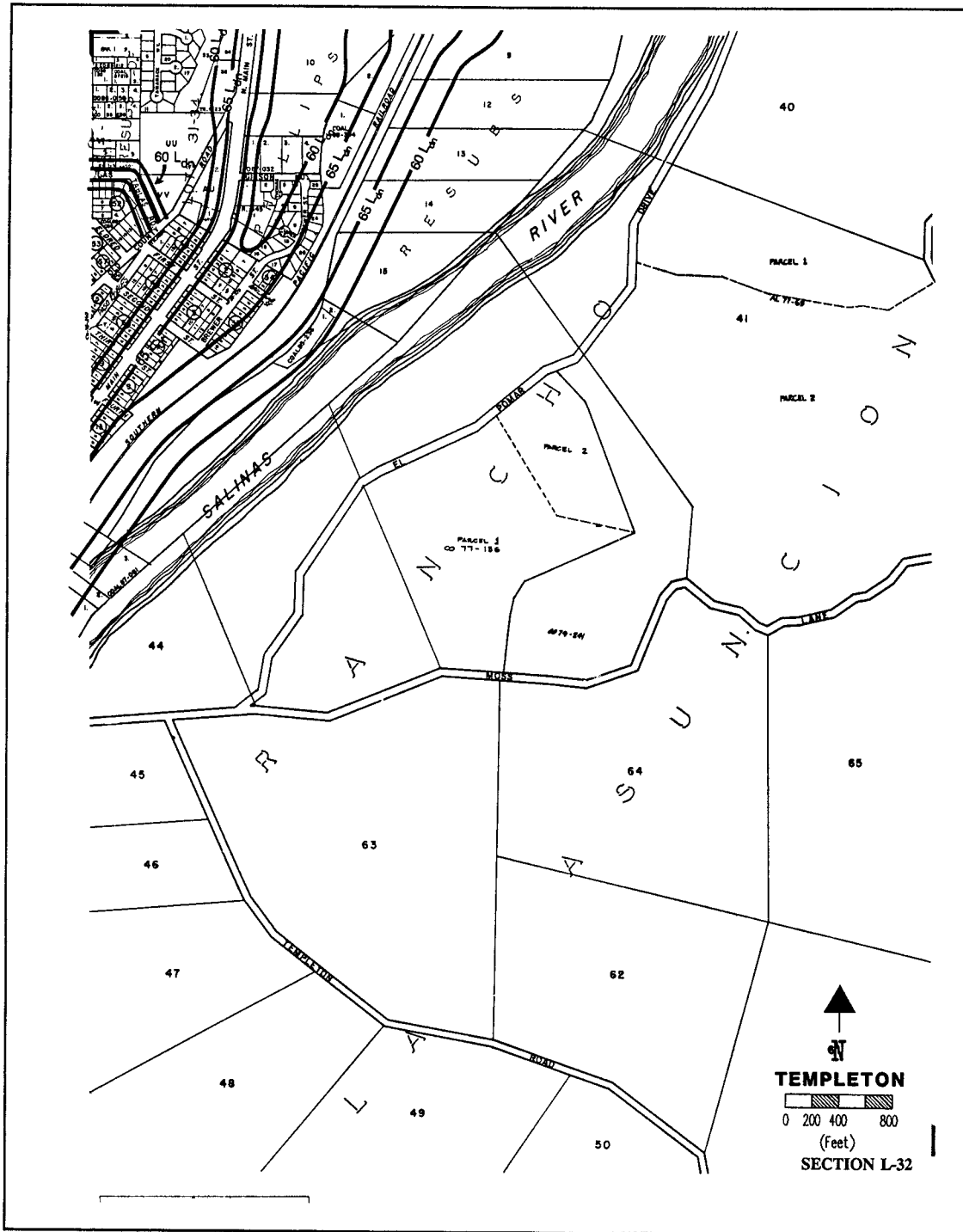

NOISE ELEMENT ■ NOISE CONTOUR MAP

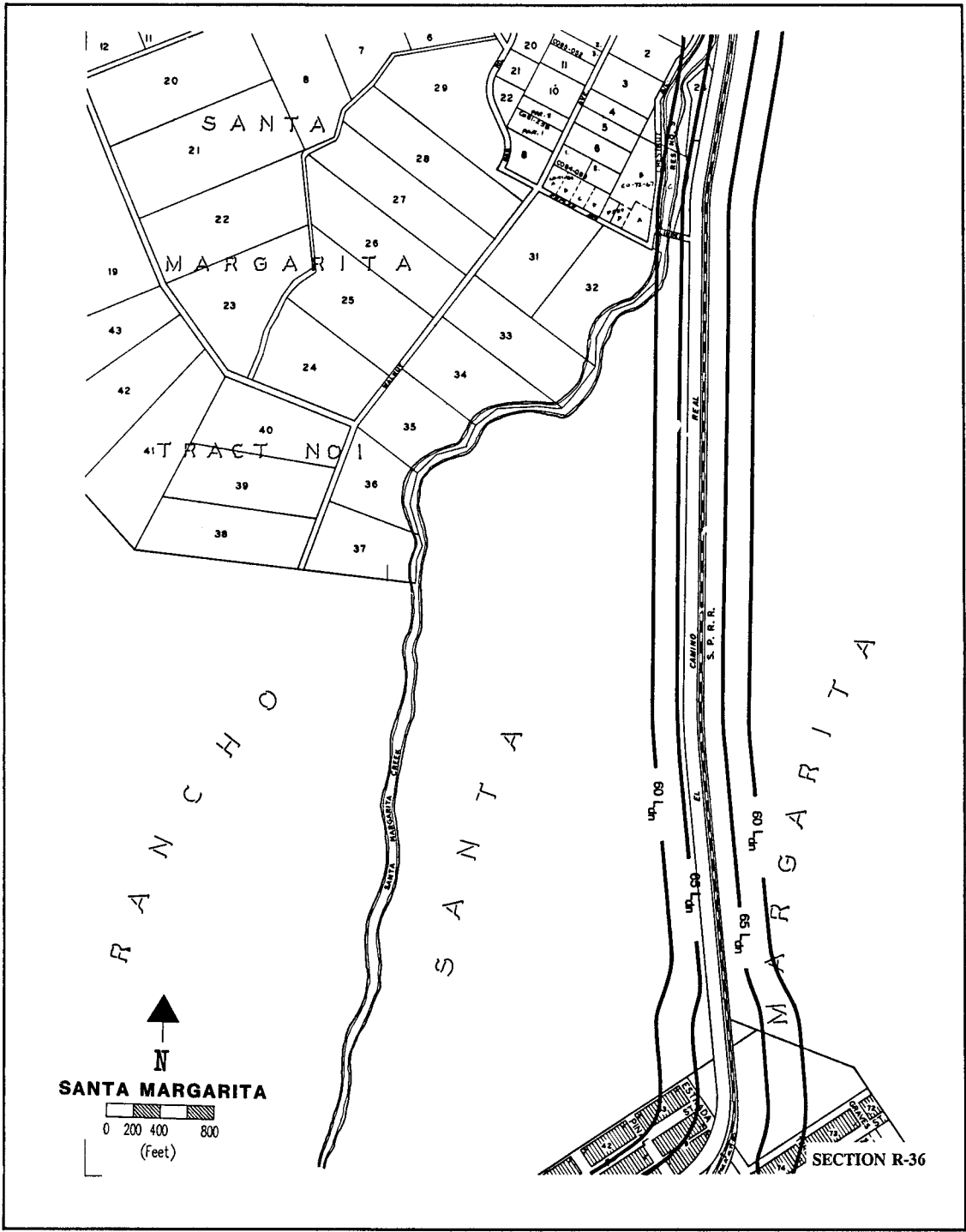

NOISE ELEMENT ■ NOISE CONTOUR MAP

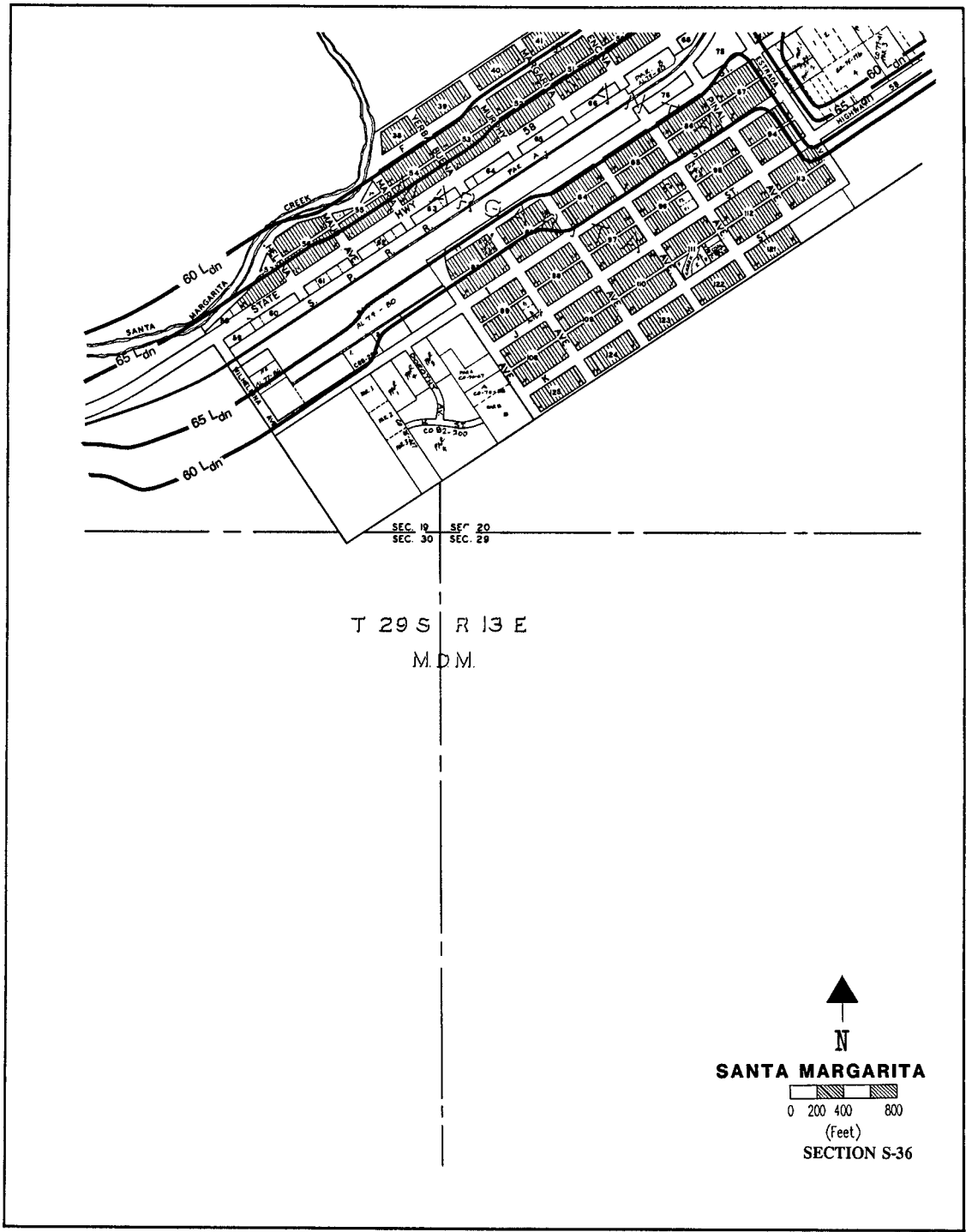

NOISE ELEMENT ■ NOISE CONTOUR MAP

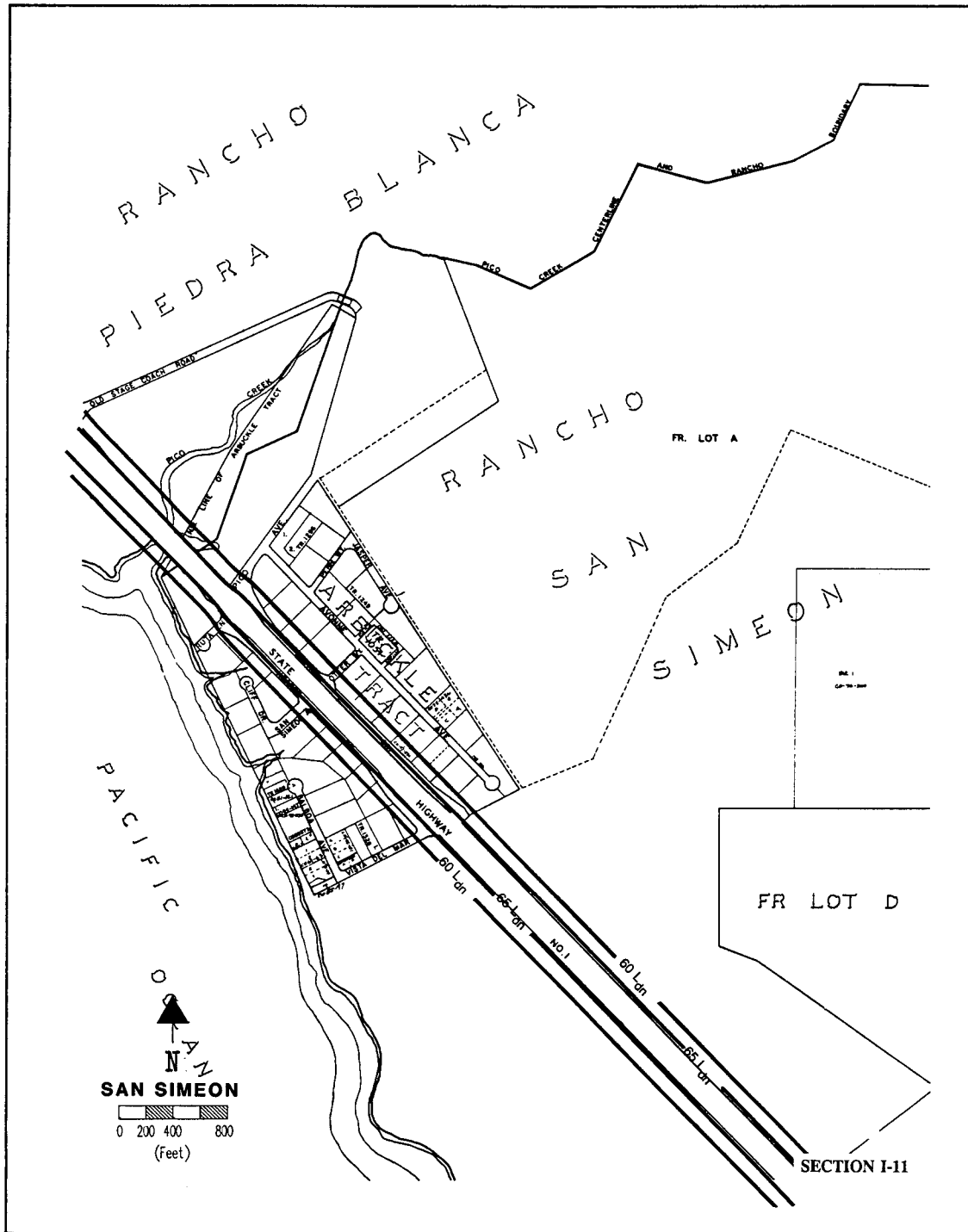

NOISE ELEMENT ■ NOISE CONTOUR MAP

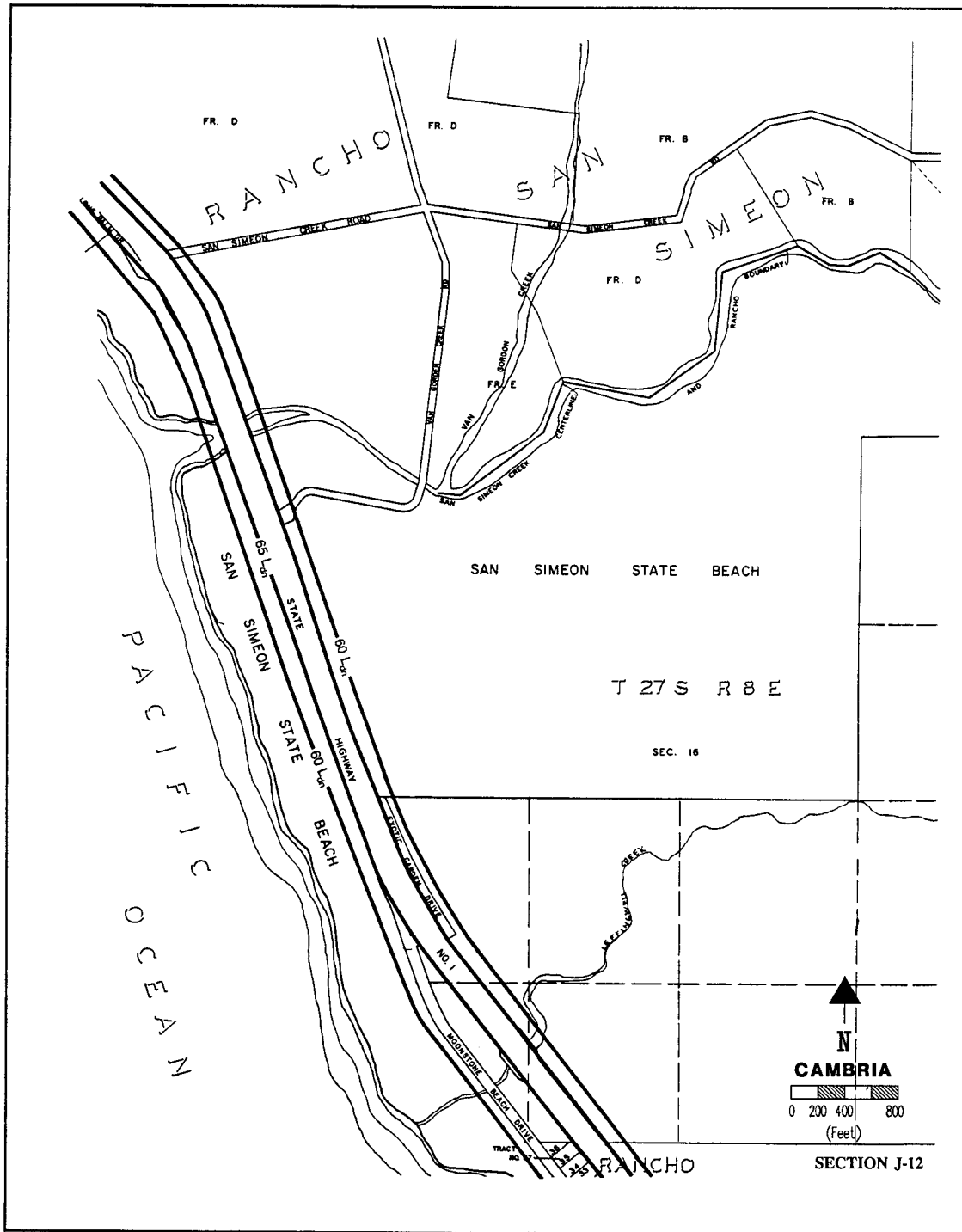

NOISE ELEMENT ■ NOISE CONTOUR MAP

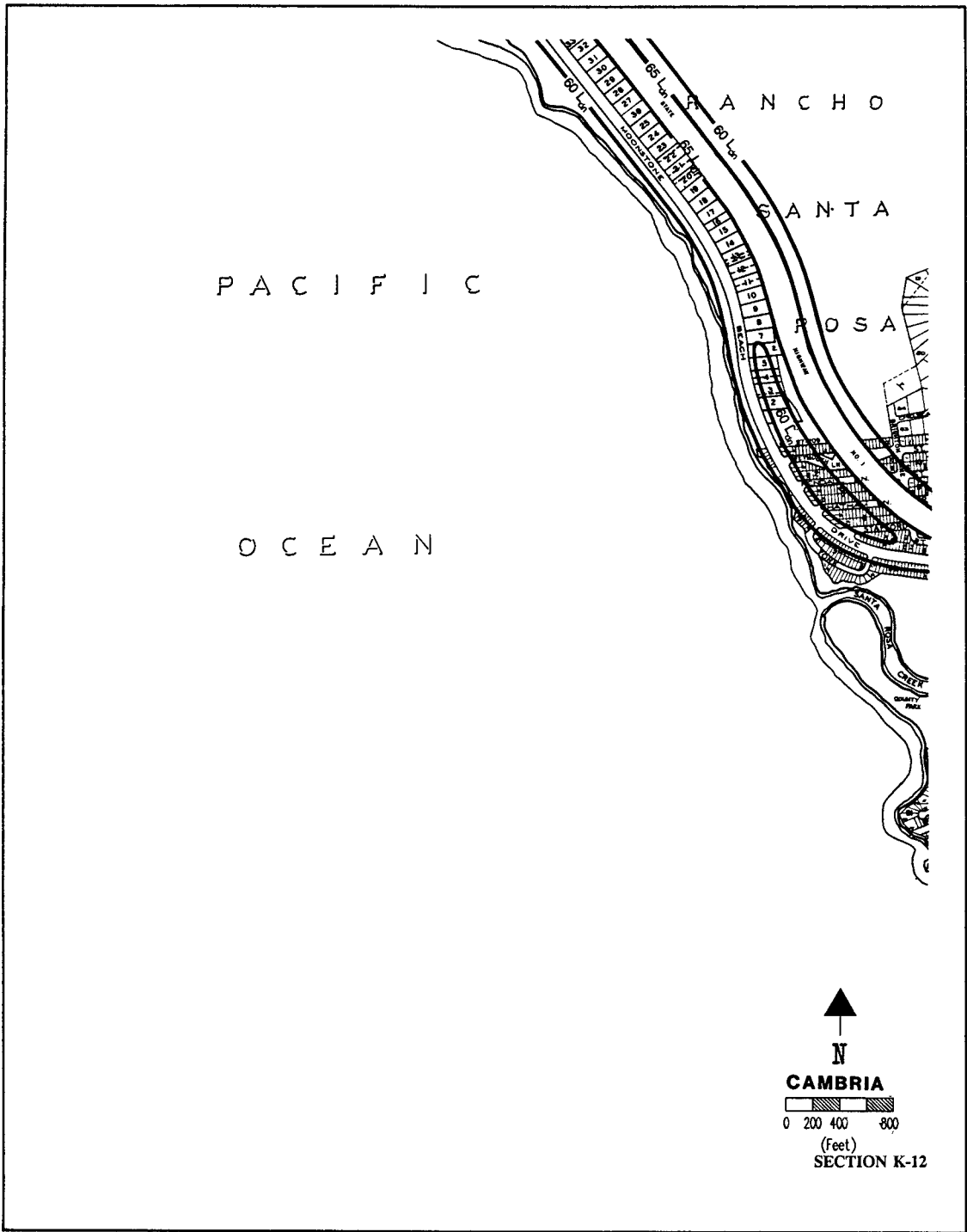

NOISE ELEMENT ■ NOISE CONTOUR MAP

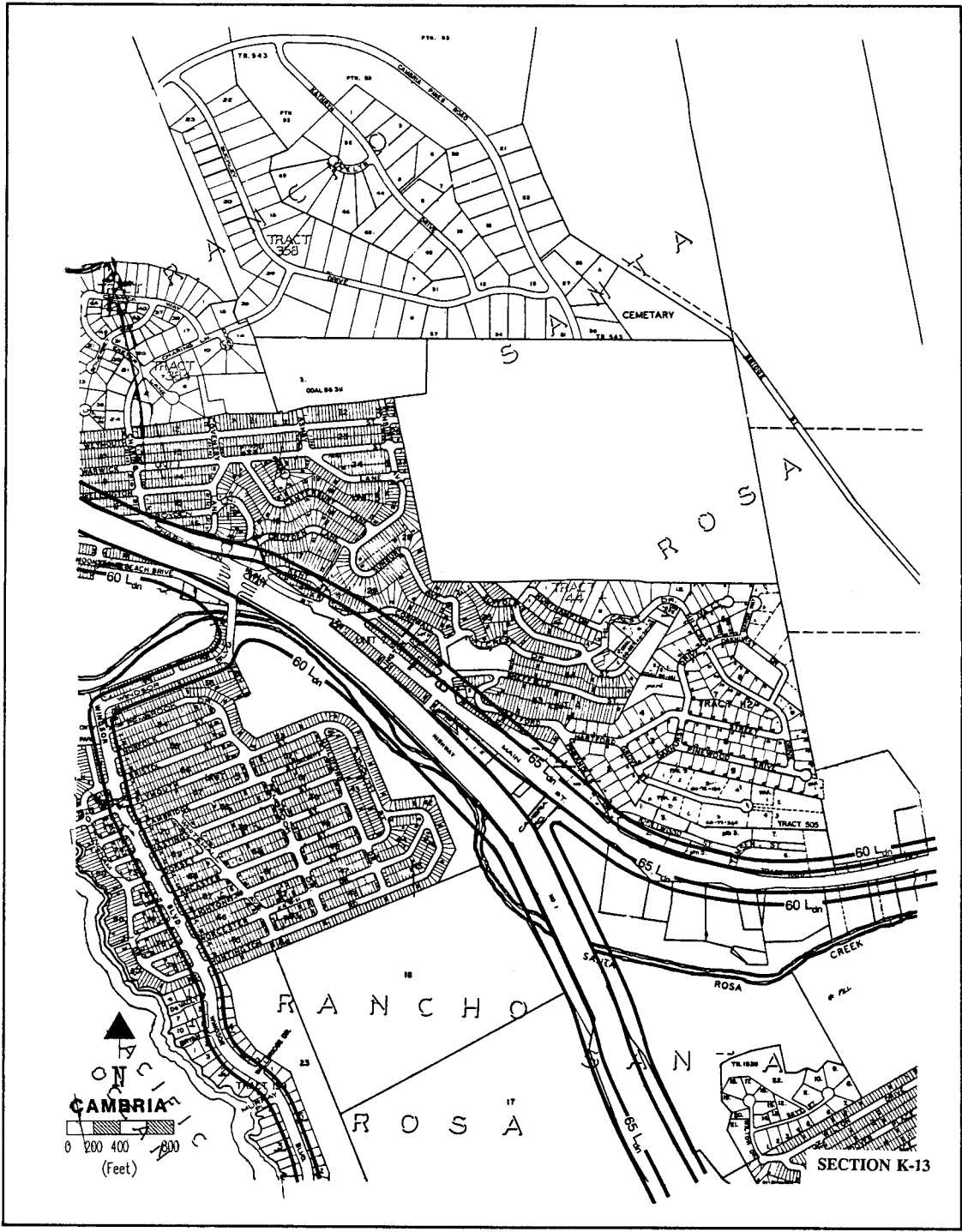

NOISE ELEMENT ■ NOISE CONTOUR MAP

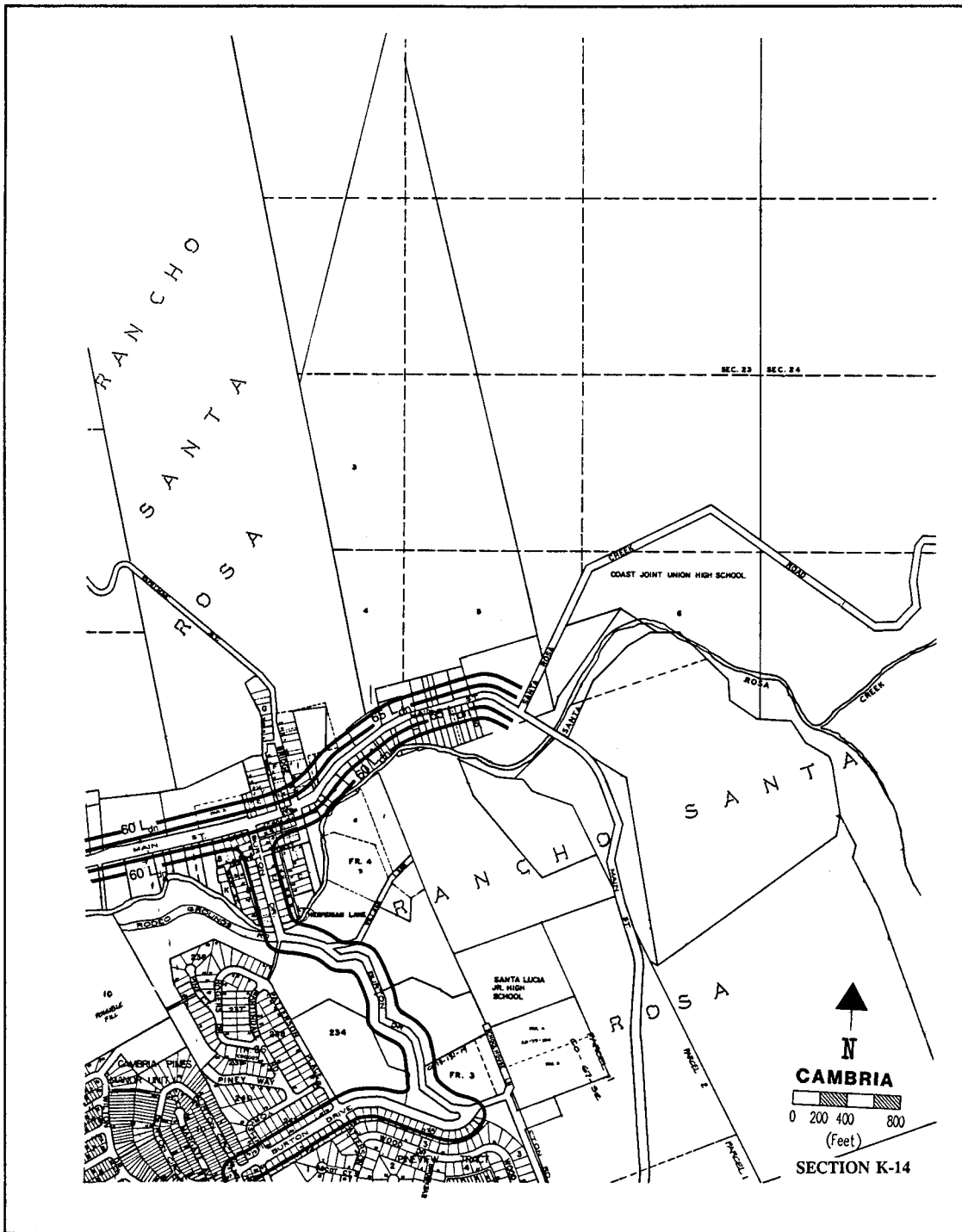

NOISE ELEMENT ■ NOISE CONTOUR MAP

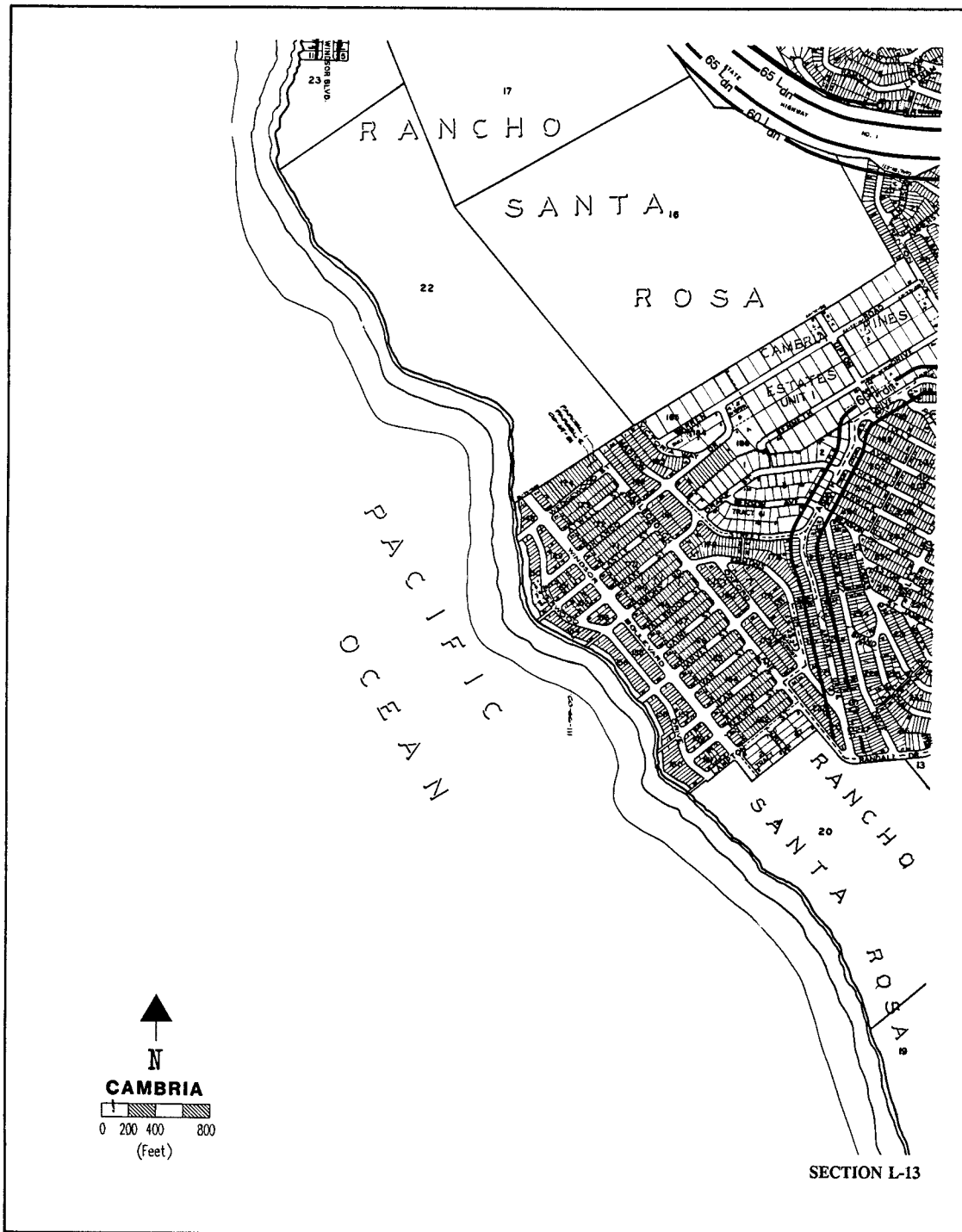

NOISE ELEMENT ■ NOISE CONTOUR MAP

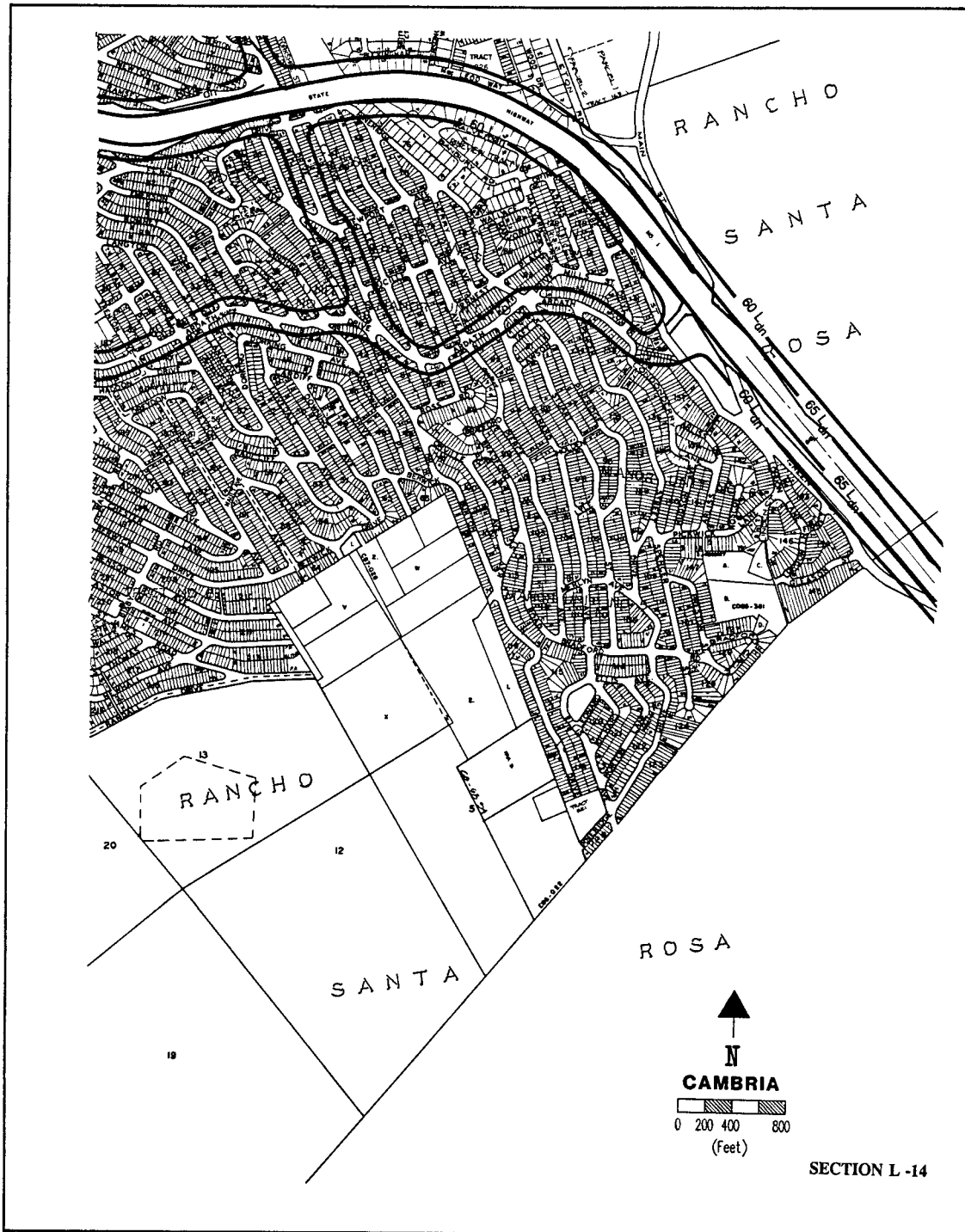

NOISE ELEMENT ■ NOISE CONTOUR MAP

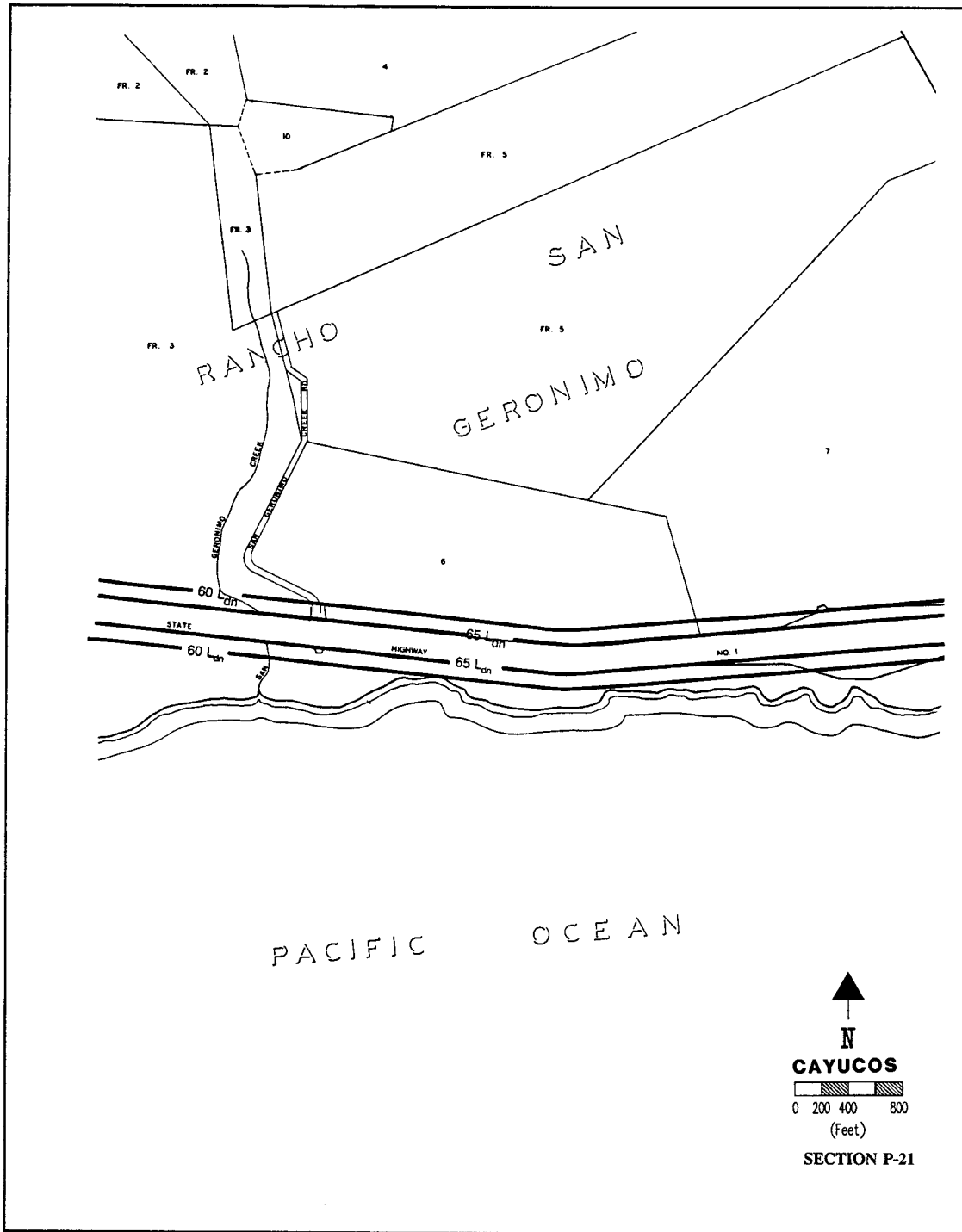

NOISE ELEMENT ■ NOISE CONTOUR MAP

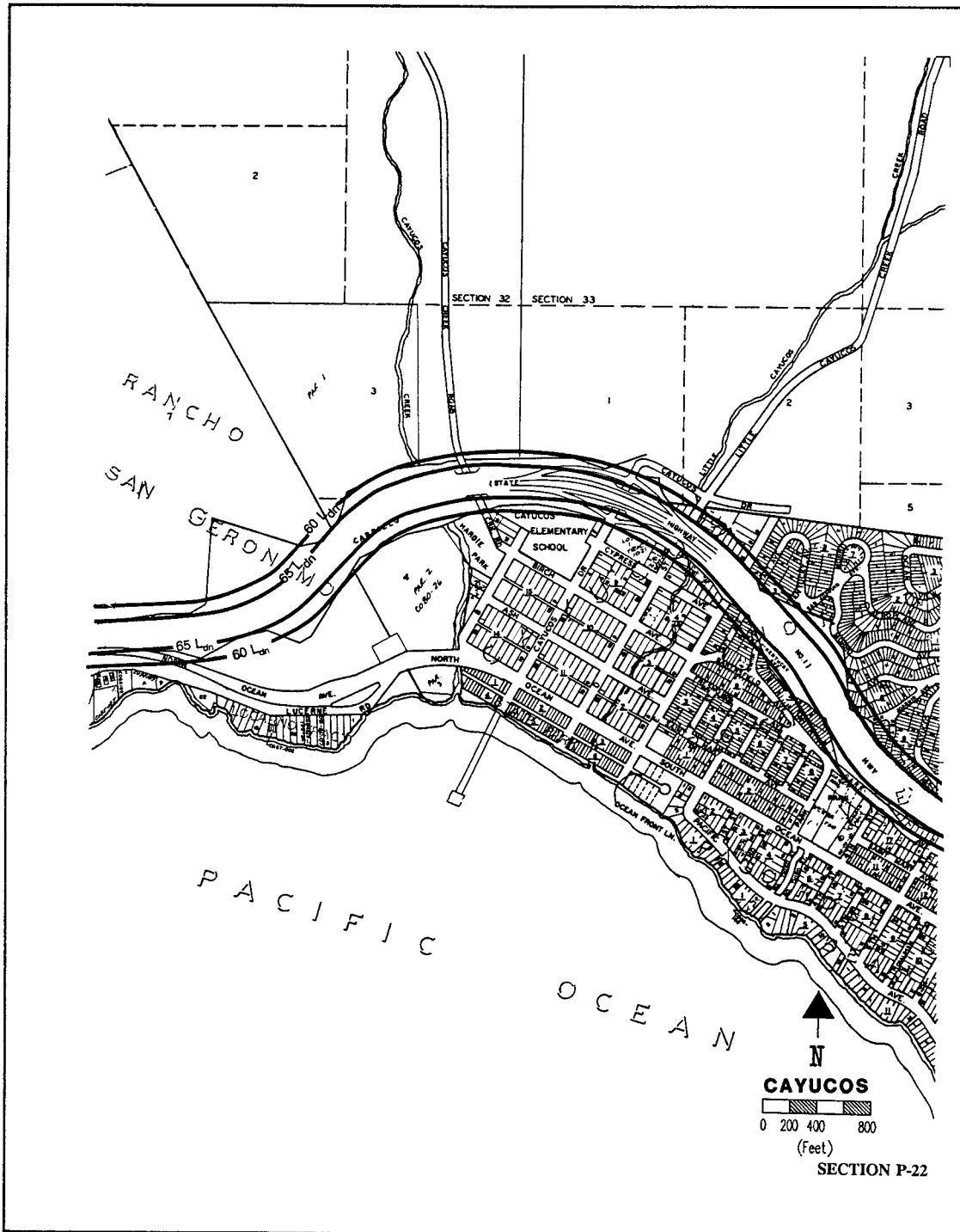

NOISE ELEMENT ■ NOISE CONTOUR MAP

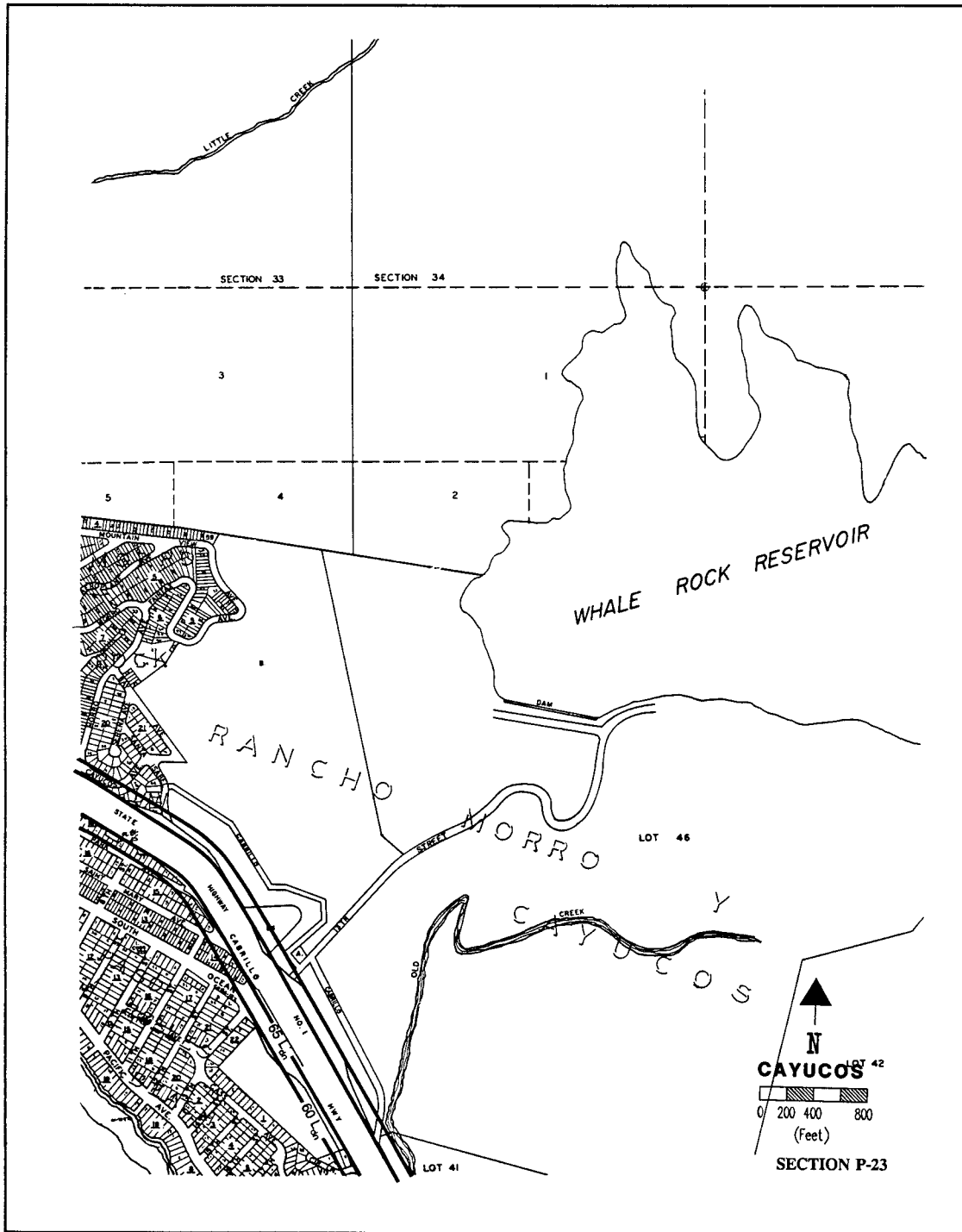

NOISE ELEMENT ■ NOISE CONTOUR MAP

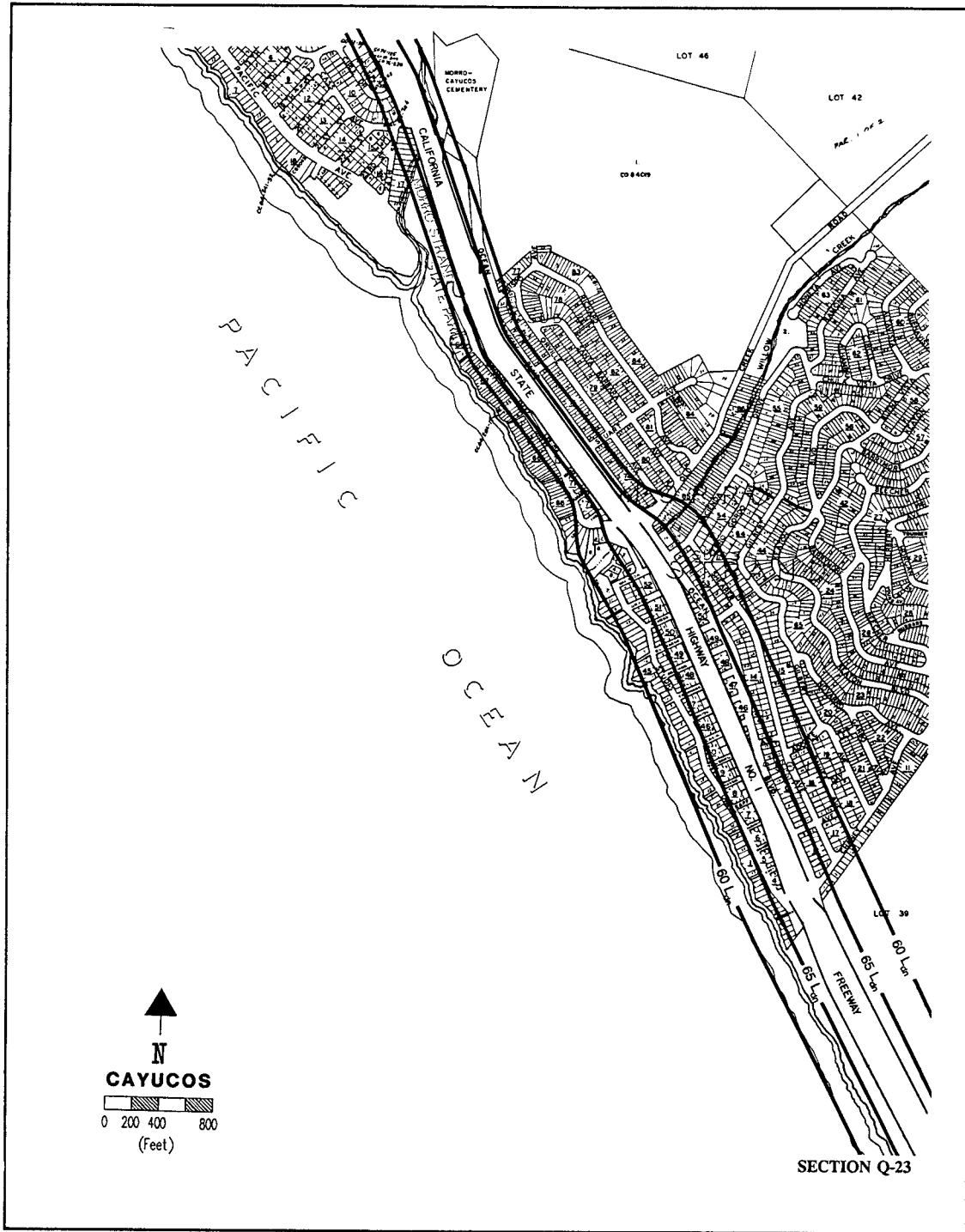

NOISE ELEMENT ■ NOISE CONTOUR MAP

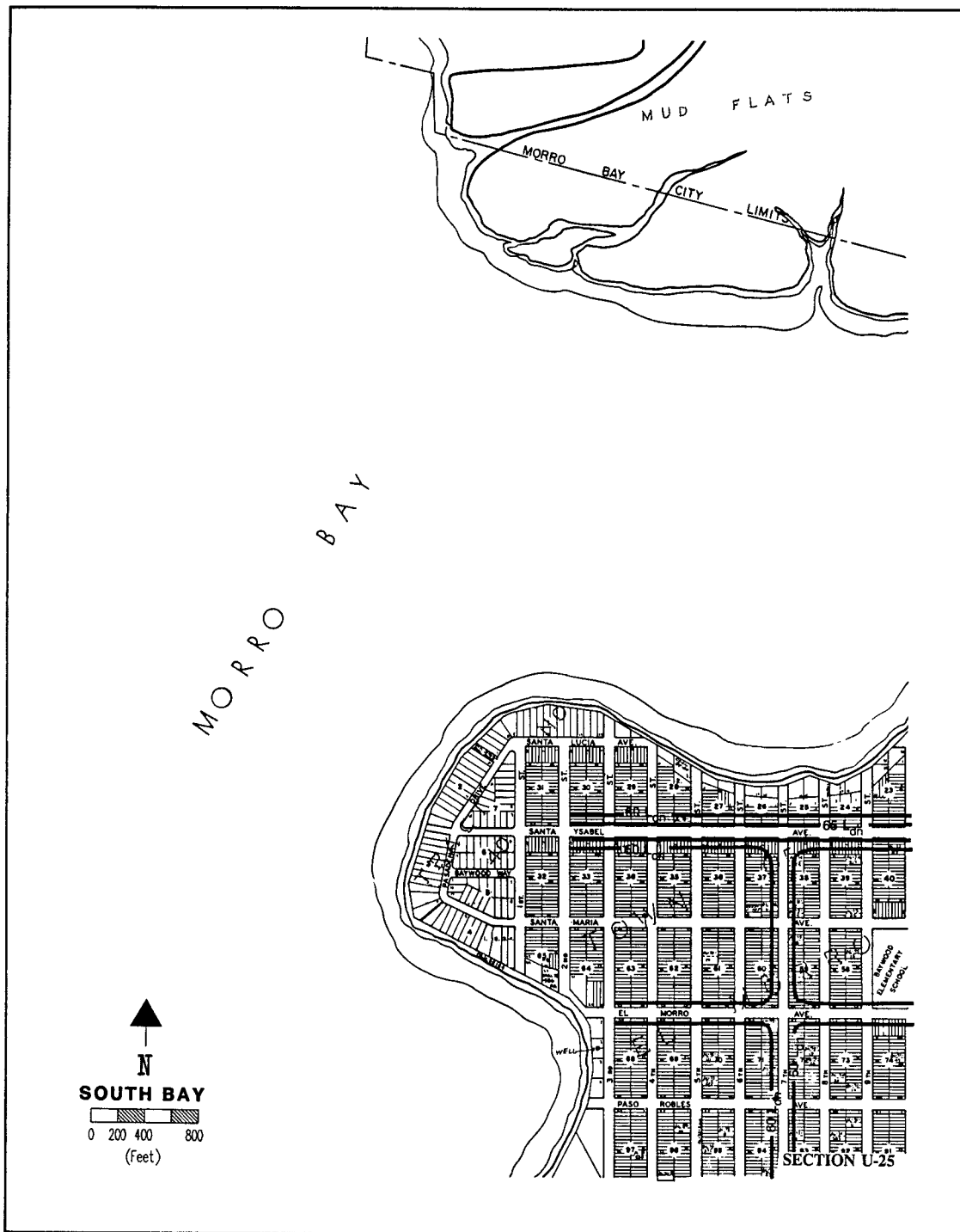

NOISE ELEMENT ■ NOISE CONTOUR MAP

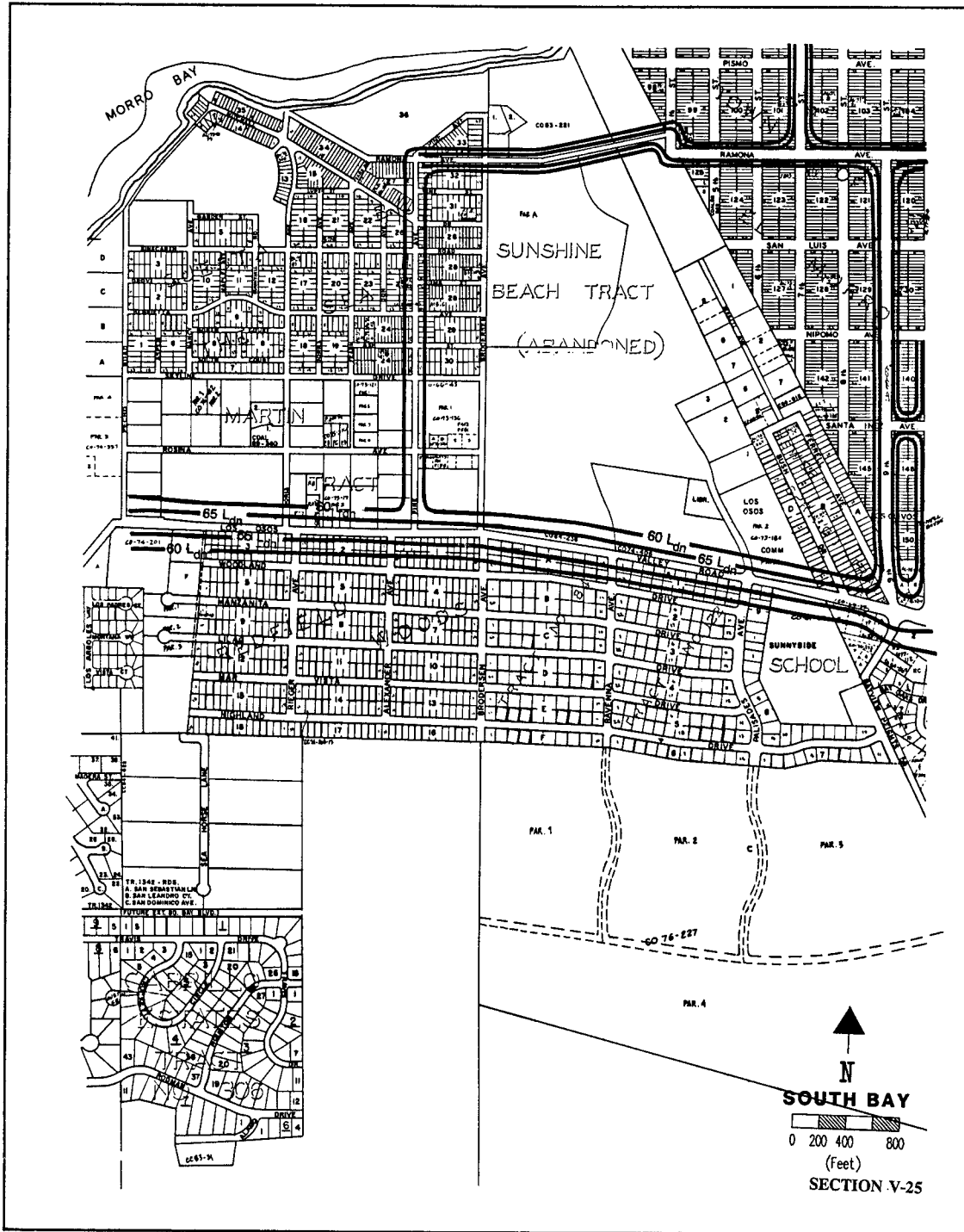

NOISE ELEMENT ■ NOISE CONTOUR MAP

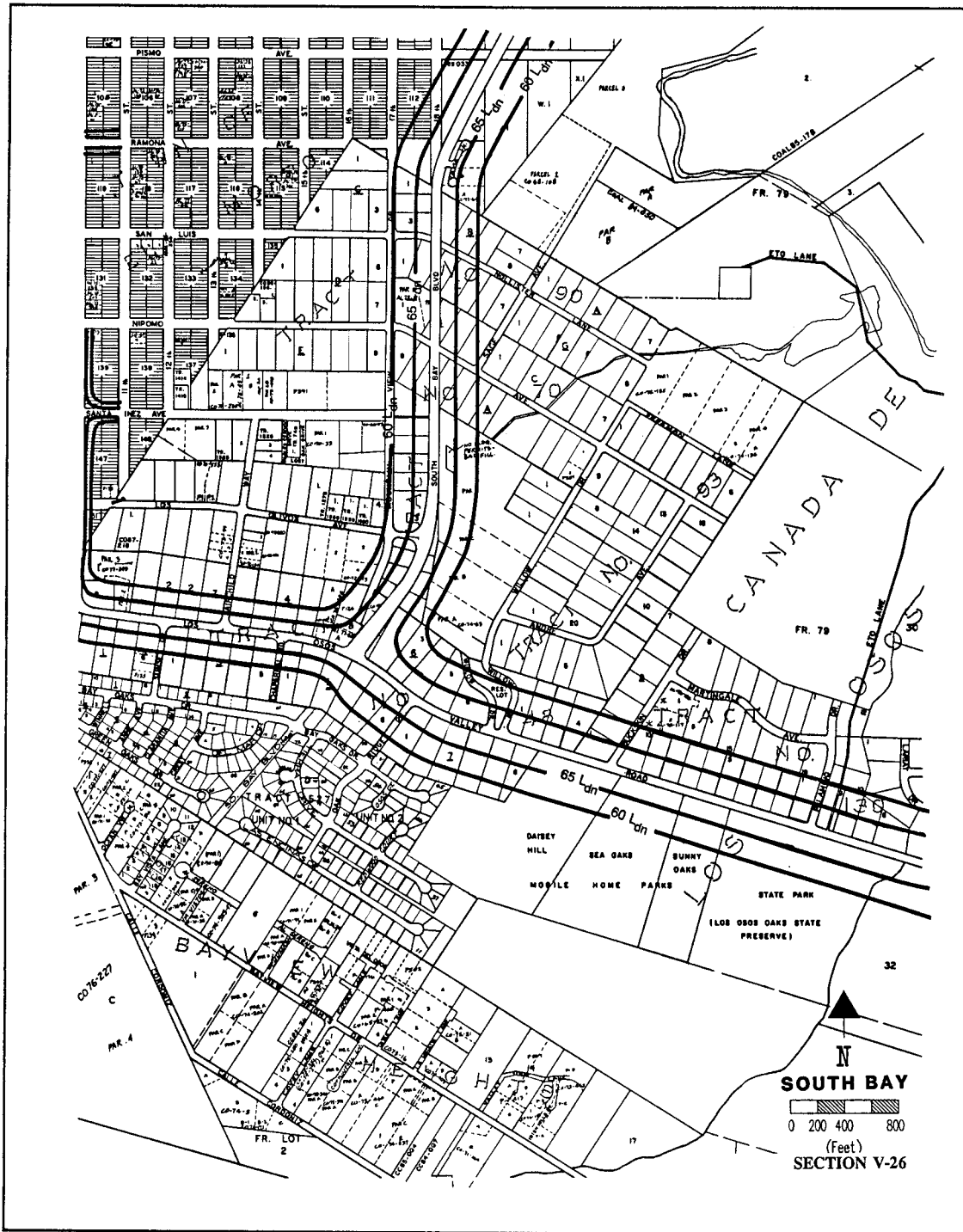

NOISE ELEMENT ■ NOISE CONTOUR MAP

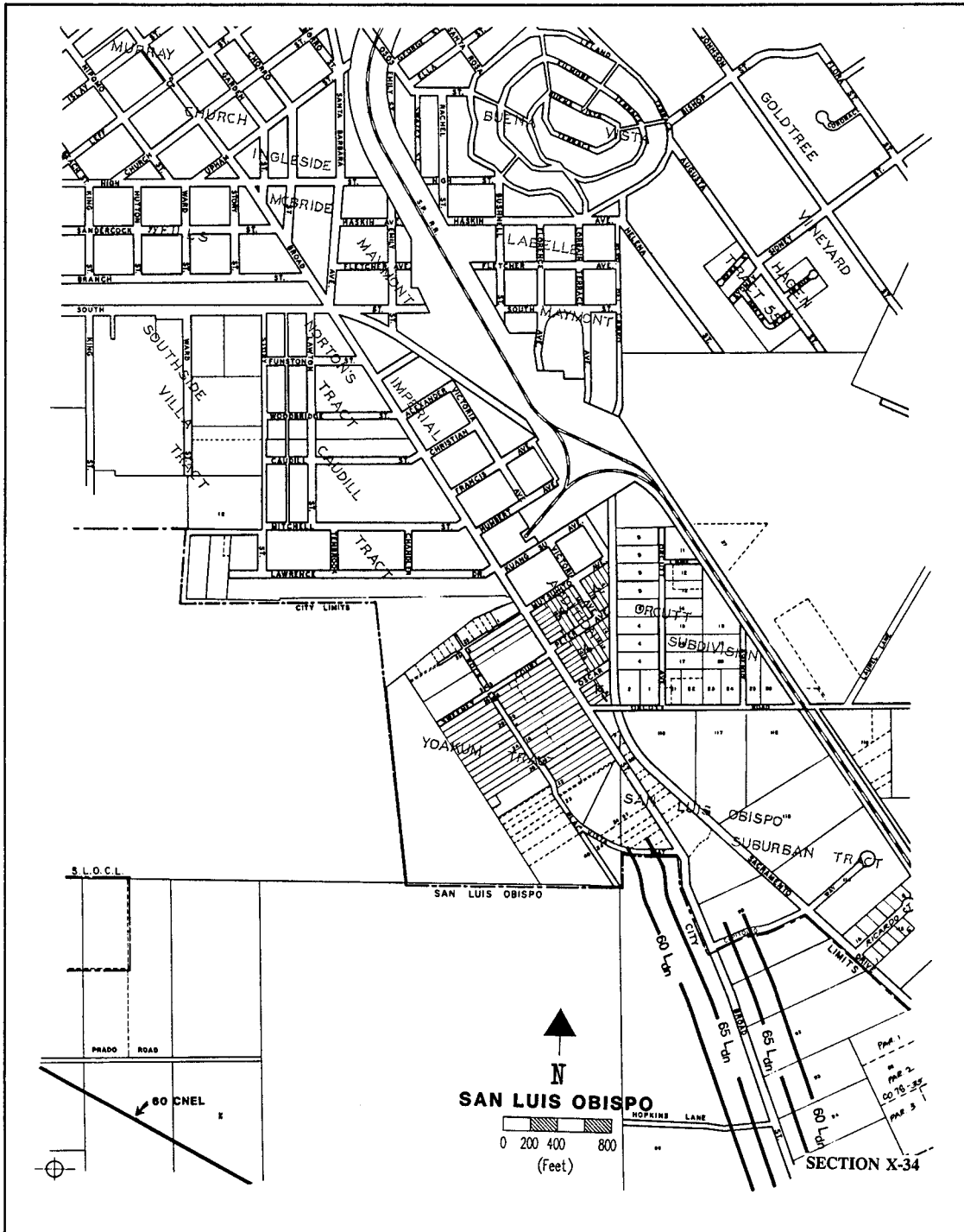

NOISE ELEMENT ■ NOISE CONTOUR MAP

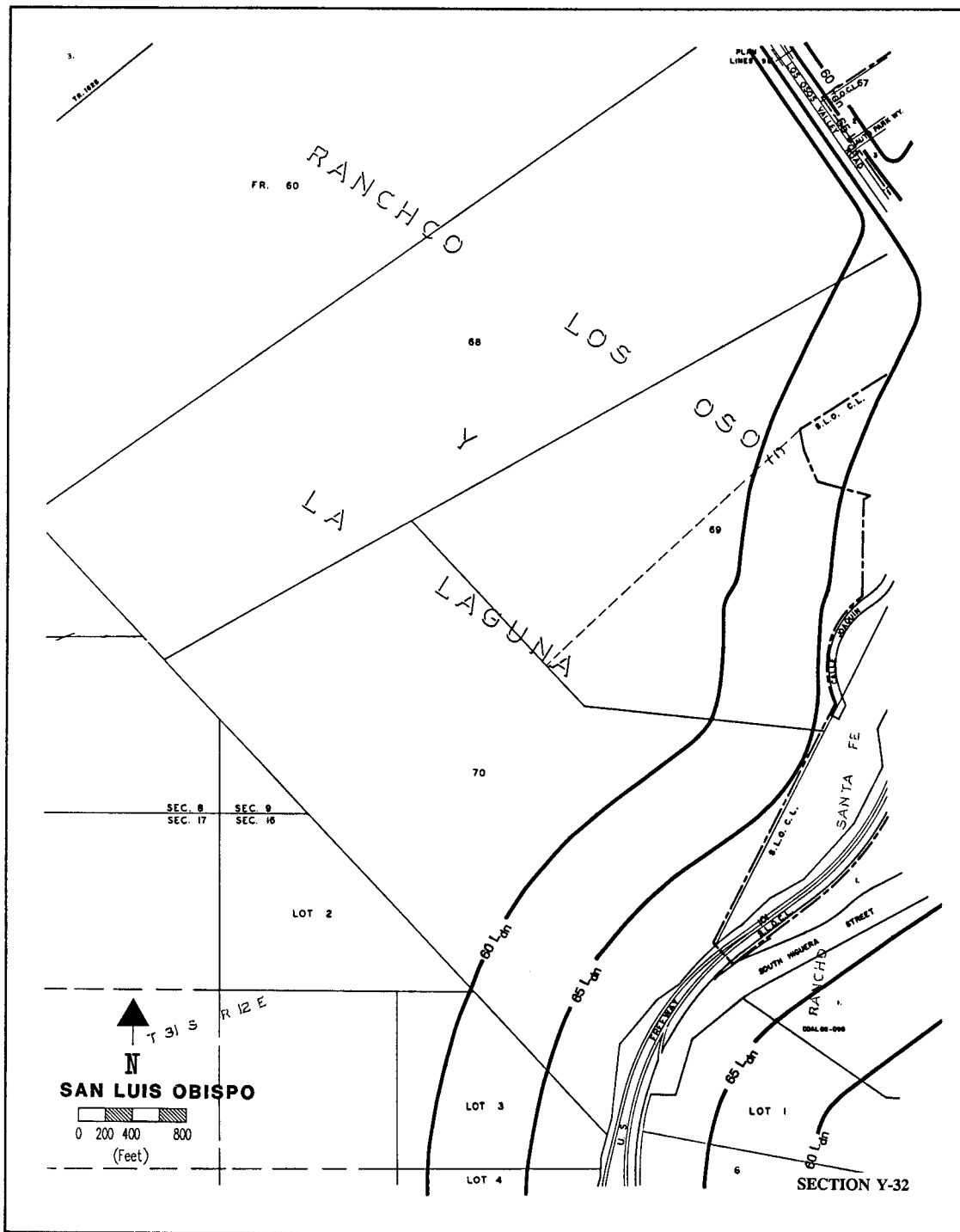

NOISE ELEMENT ■ NOISE CONTOUR MAP

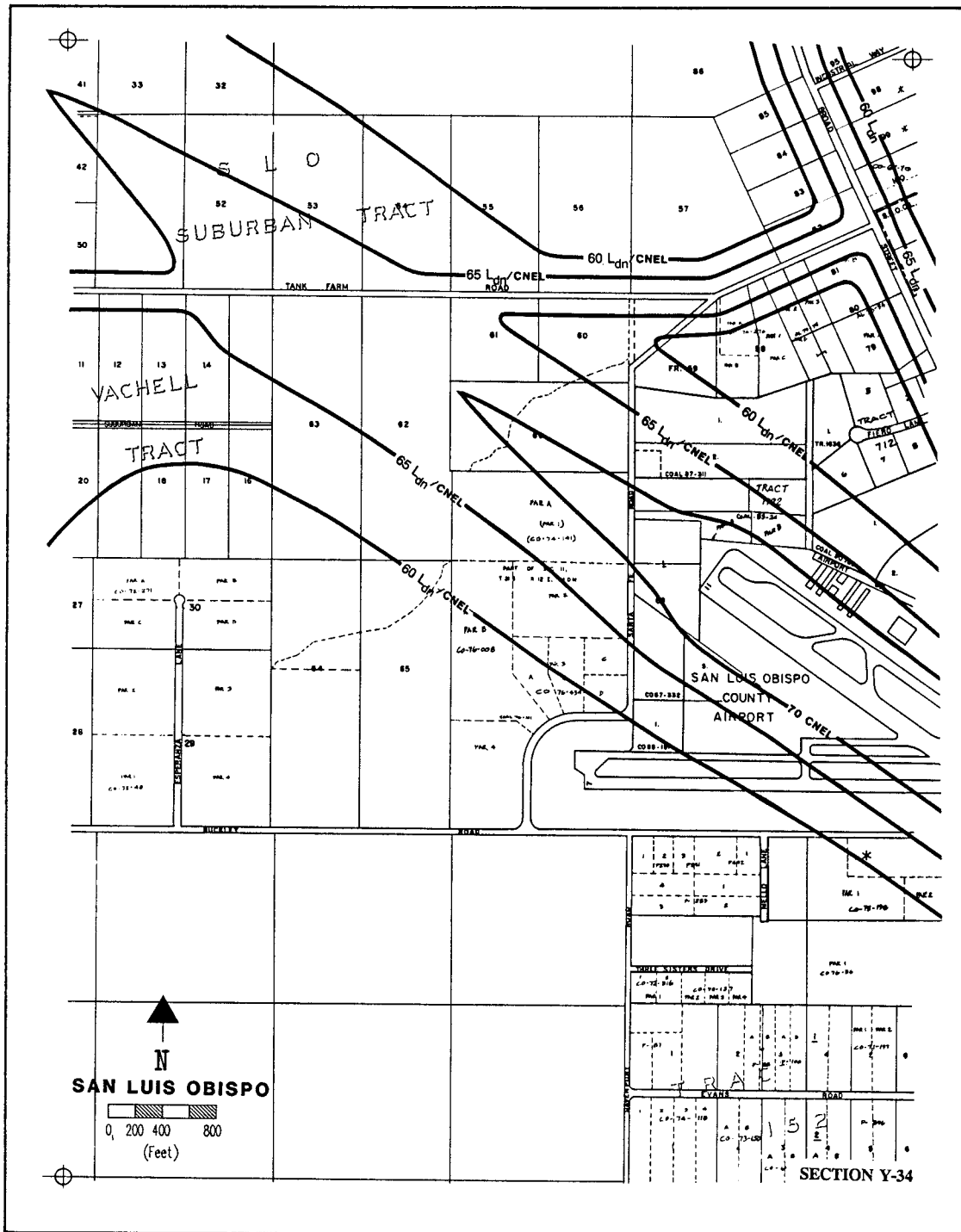

NOISE ELEMENT ■ NOISE CONTOUR MAP

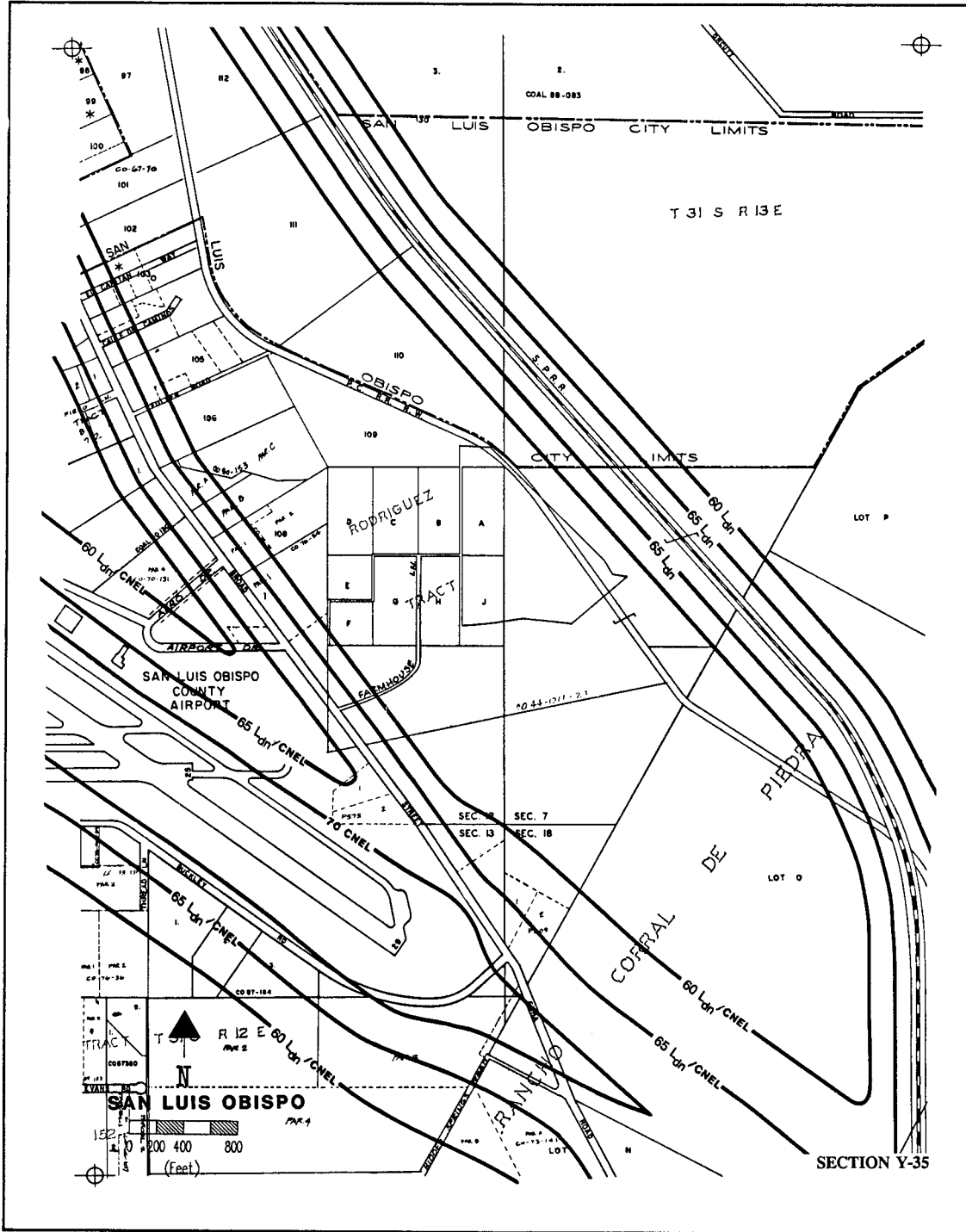

NOISE ELEMENT ■ NOISE CONTOUR MAP

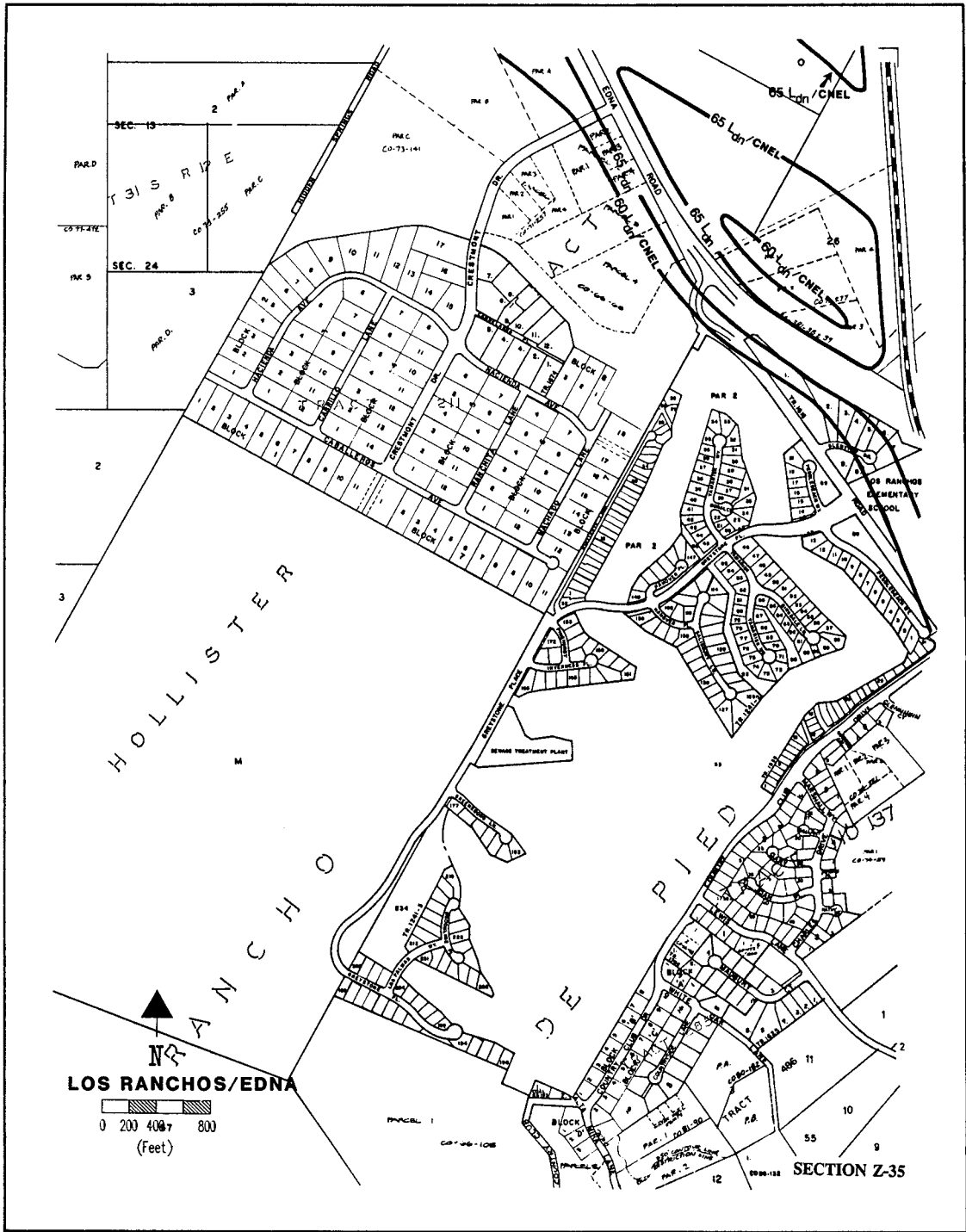

NOISE ELEMENT ■ NOISE CONTOUR MAP

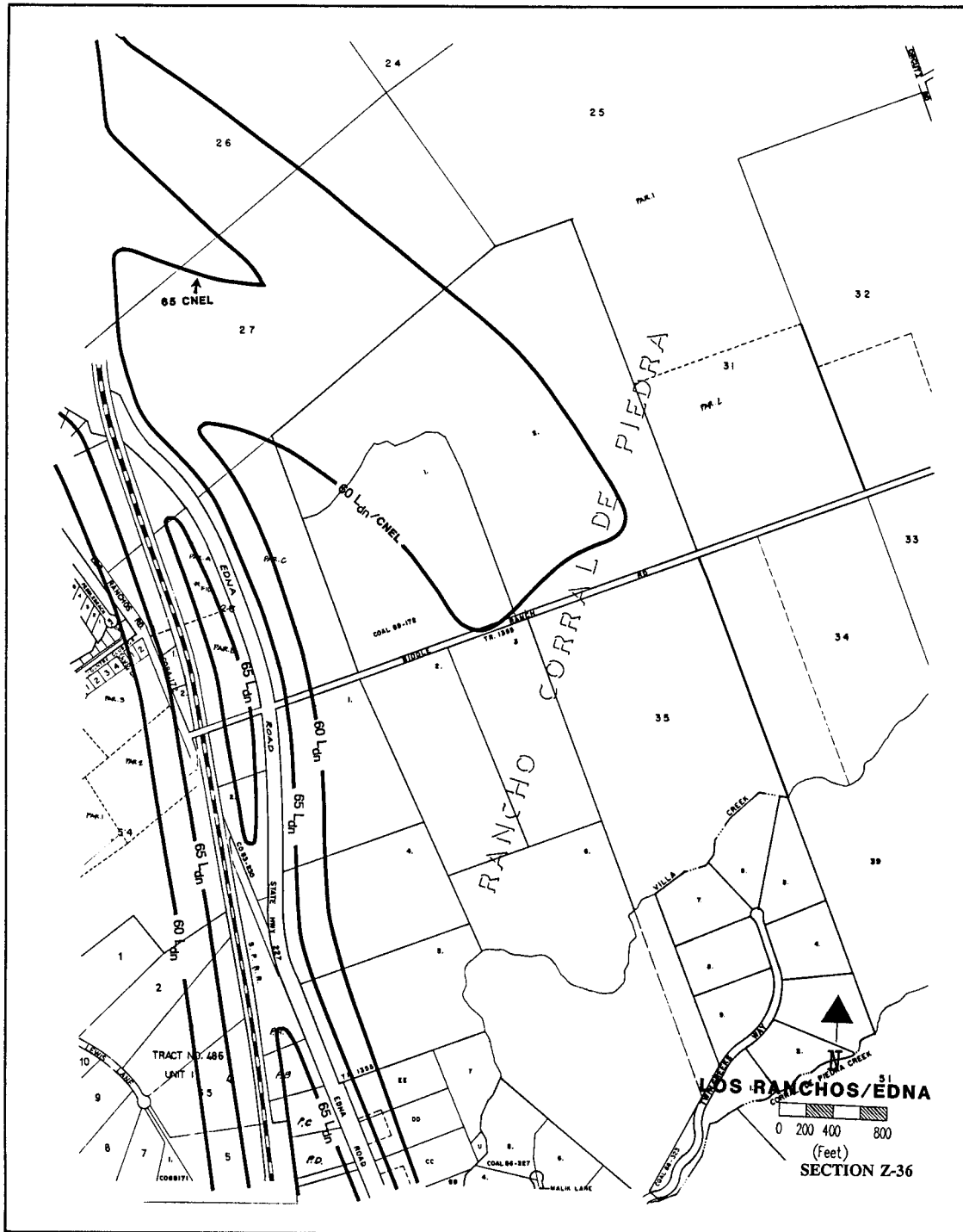

NOISE ELEMENT ■ NOISE CONTOUR MAP

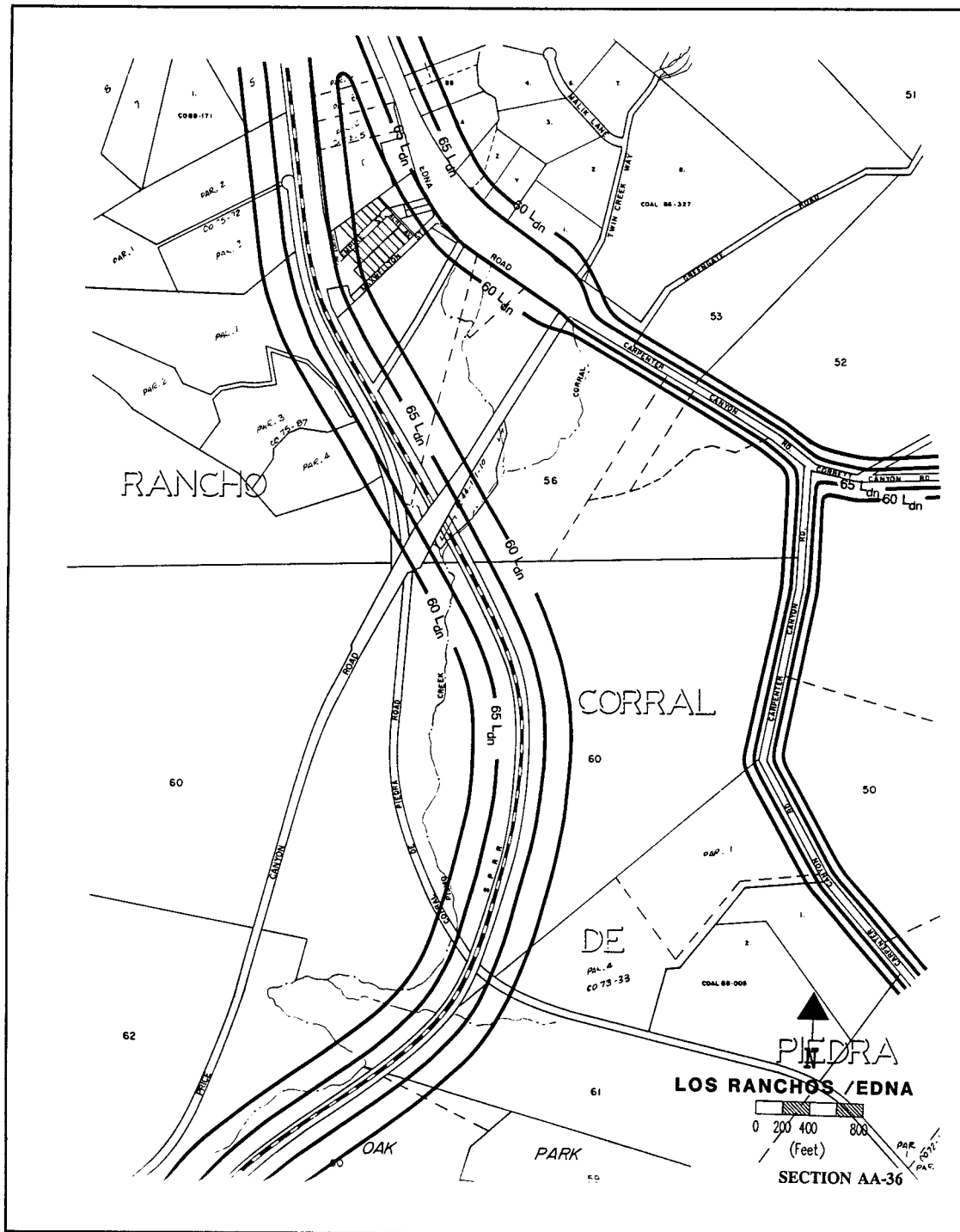

NOISE ELEMENT ■ NOISE CONTOUR MAP

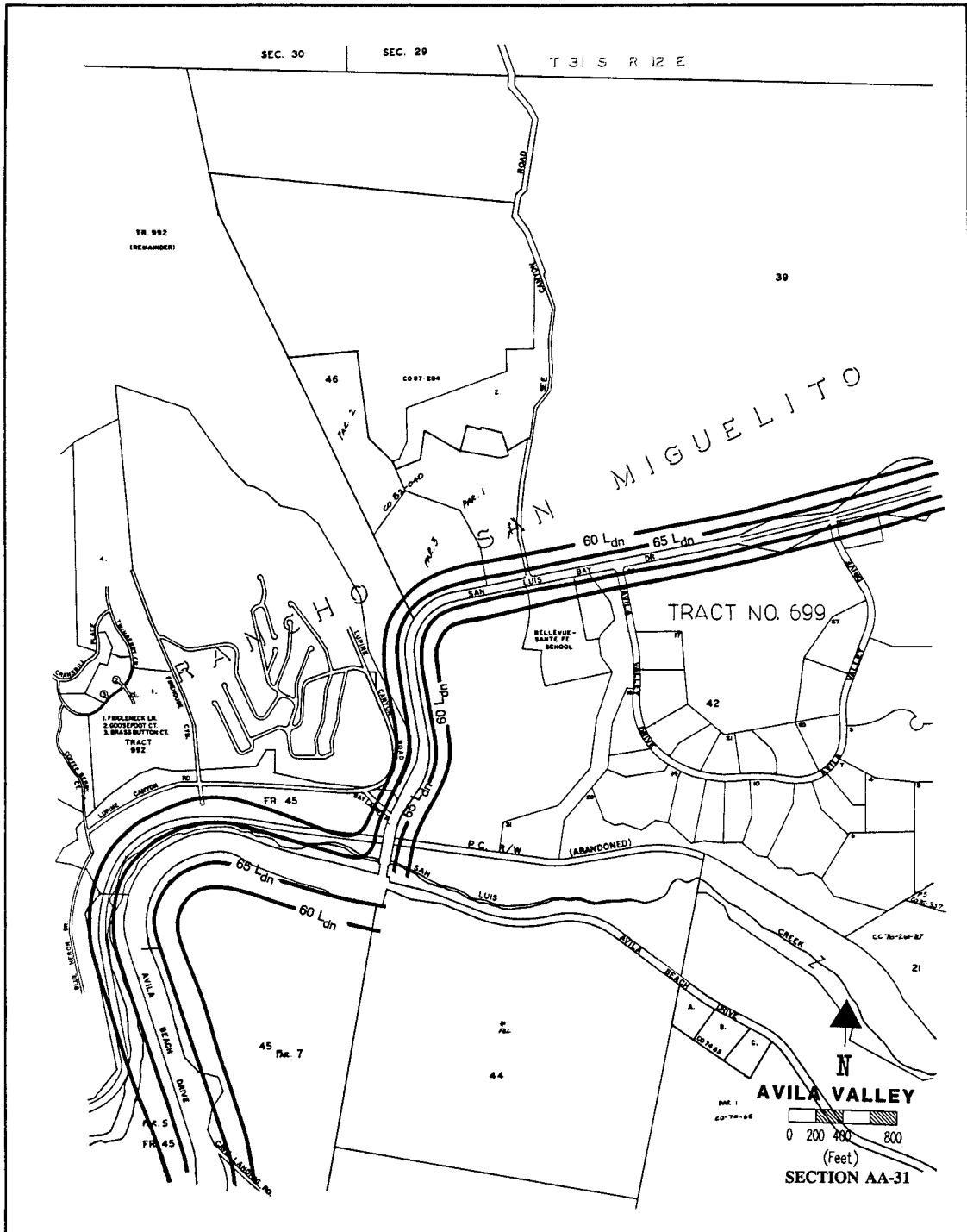

NOISE ELEMENT ■ NOISE CONTOUR MAP

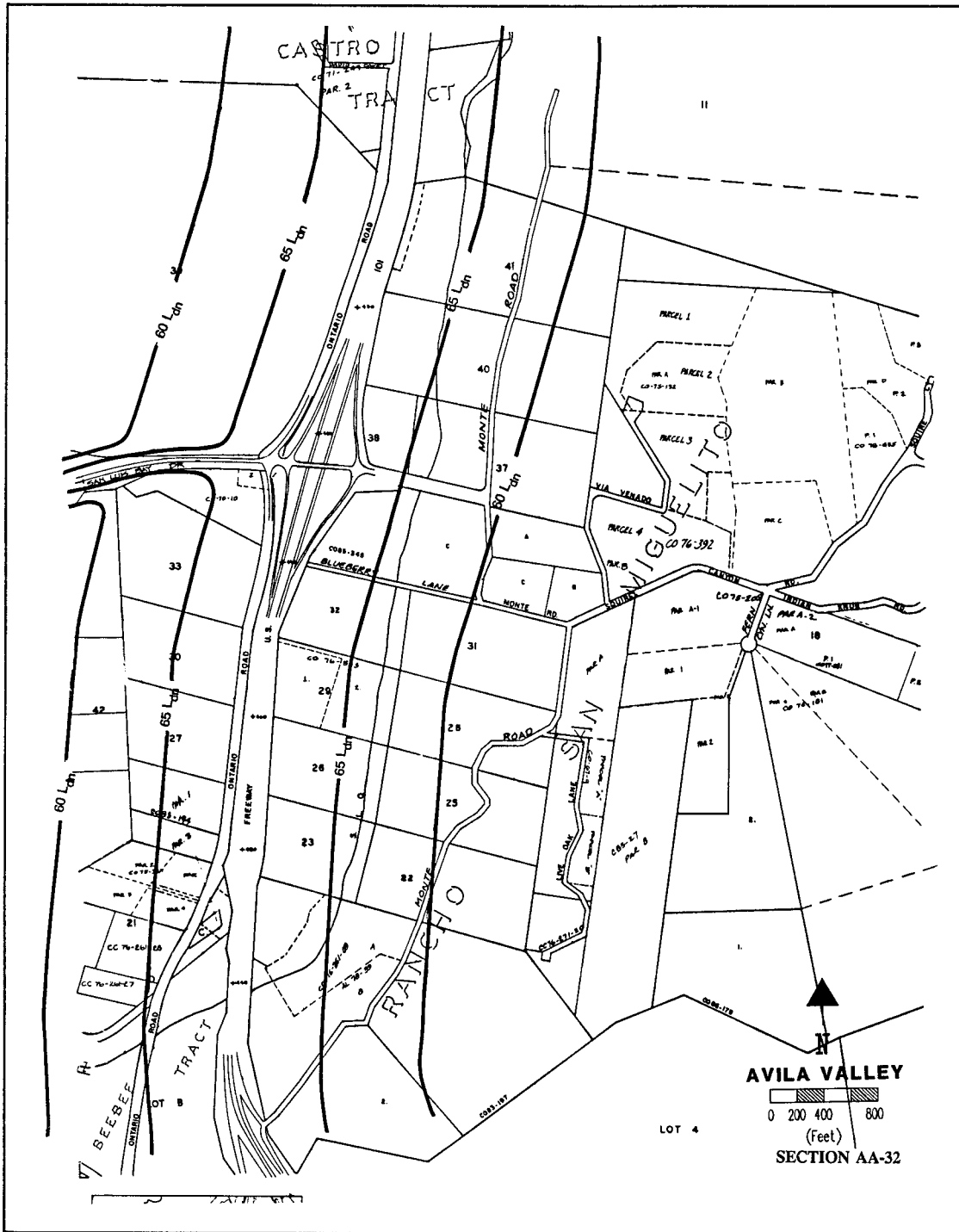

NOISE ELEMENT ■ NOISE CONTOUR MAP

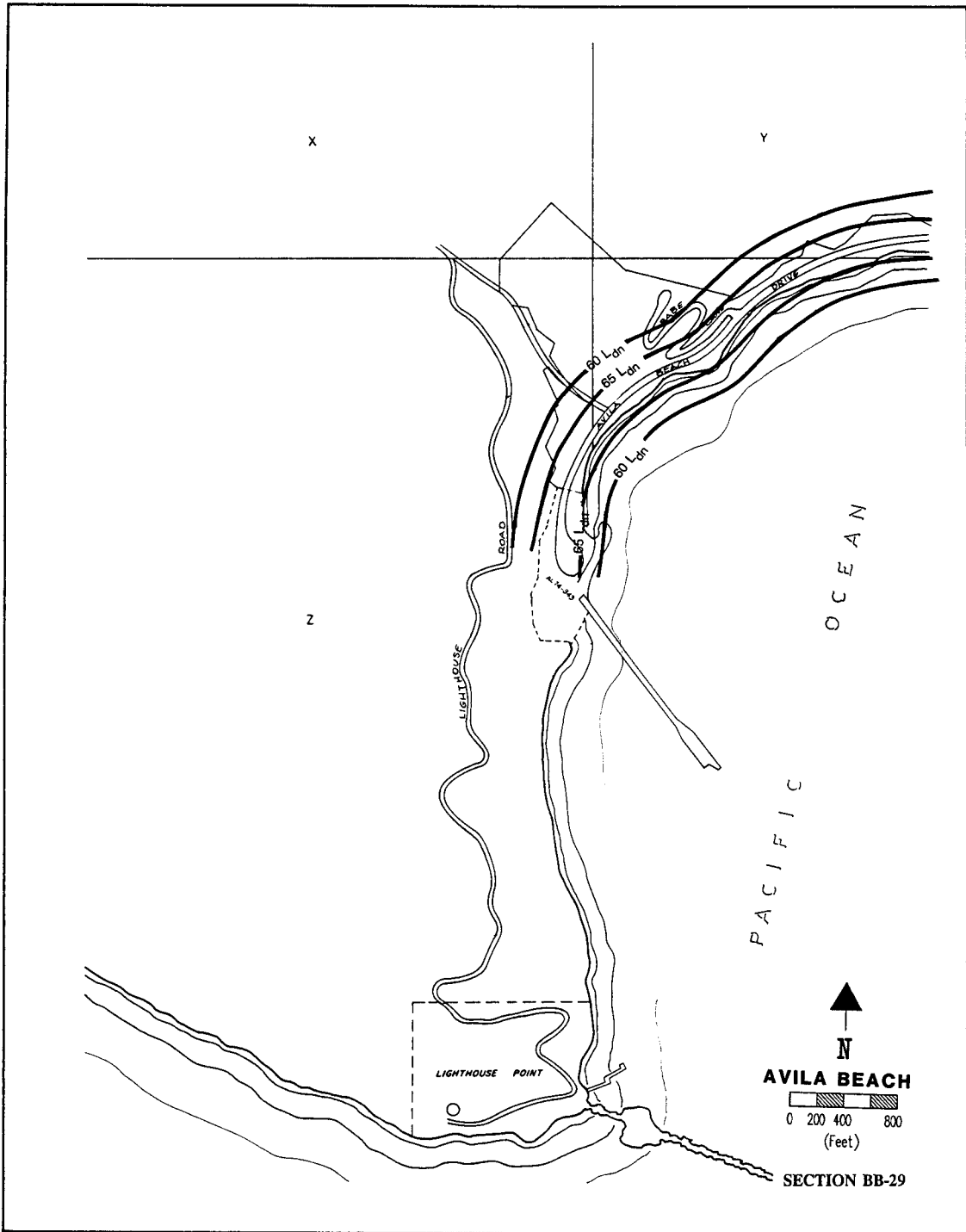

NOISE ELEMENT ■ NOISE CONTOUR MAP

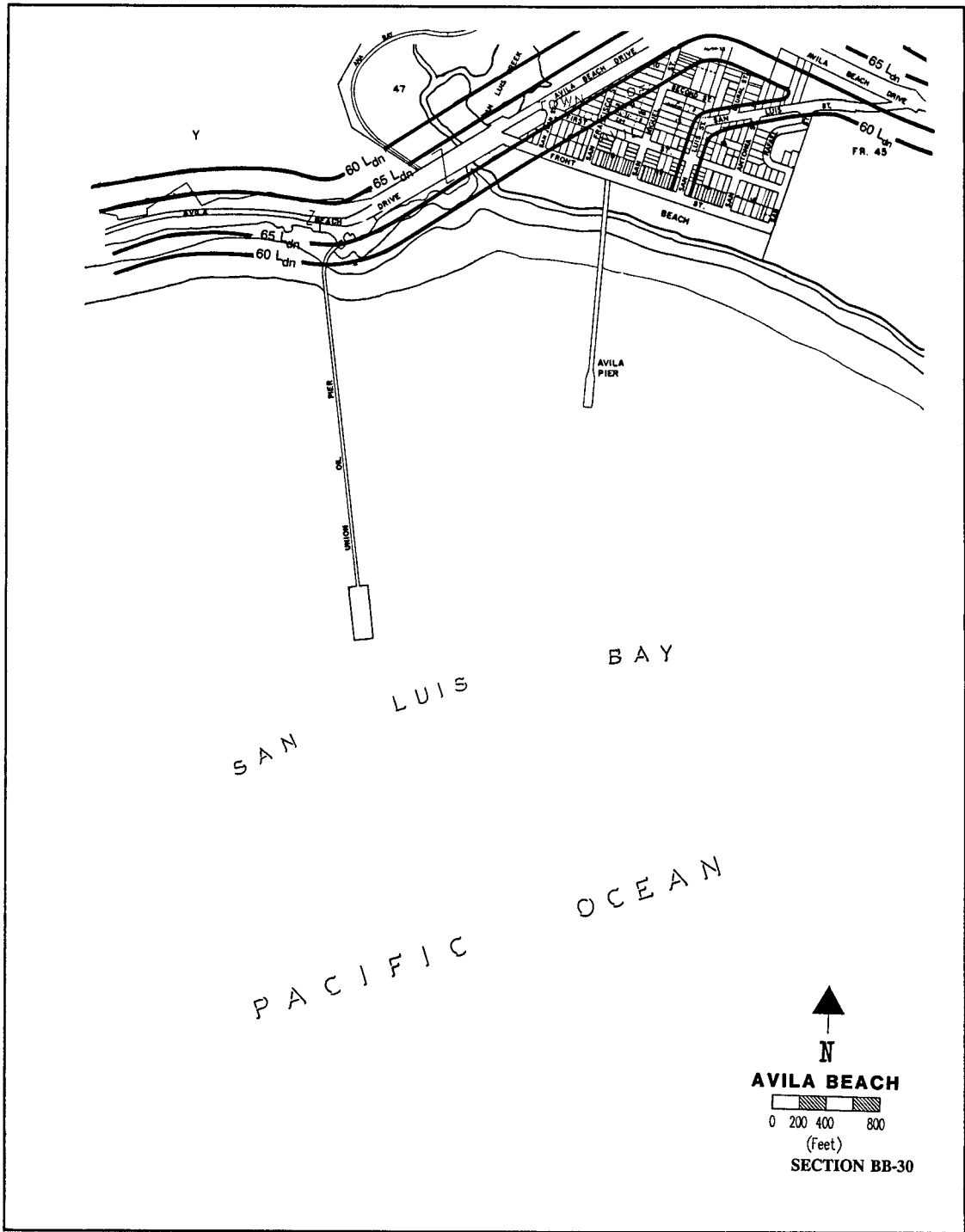

NOISE ELEMENT ■ NOISE CONTOUR MAP

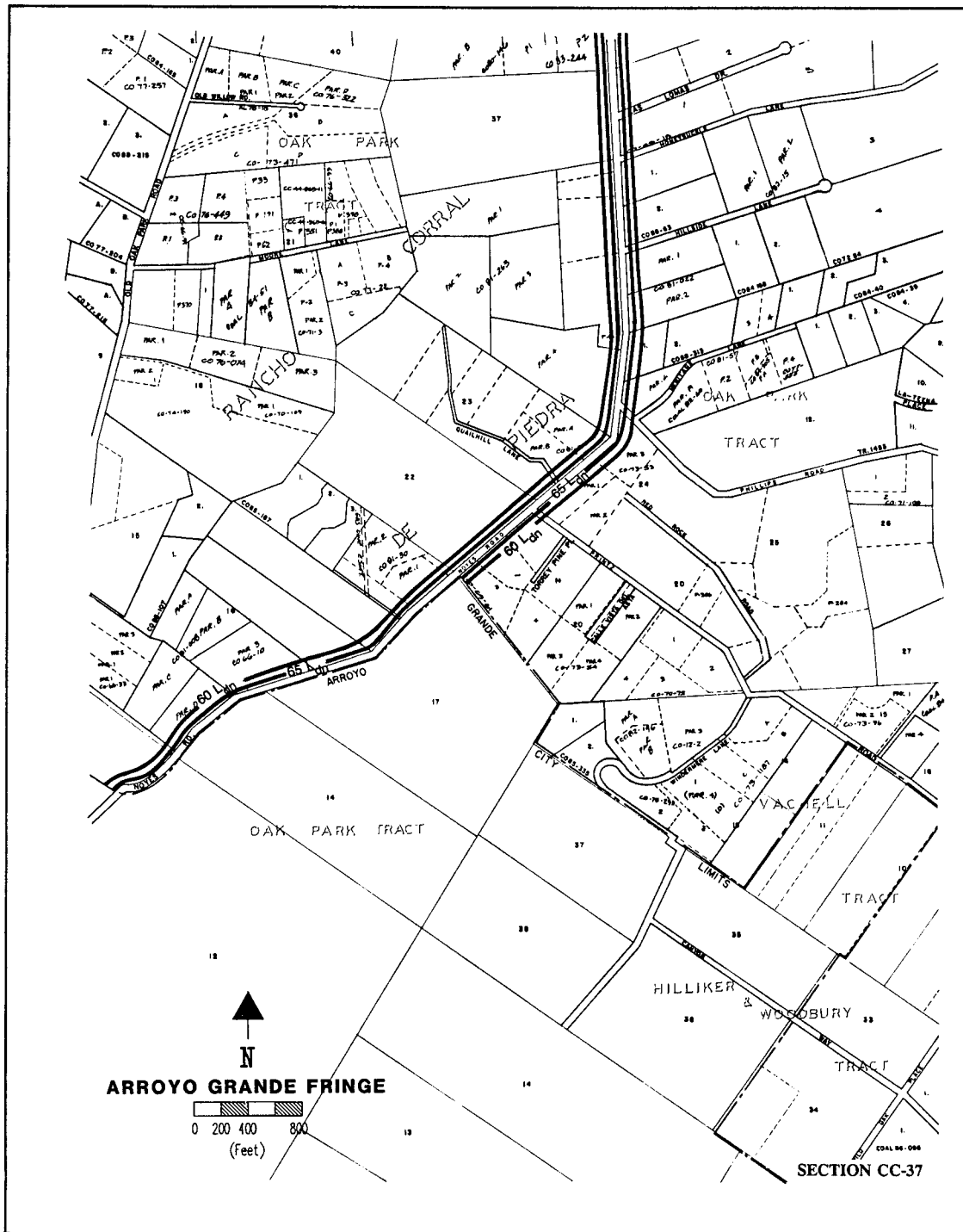

NOISE ELEMENT ■ NOISE CONTOUR MAP

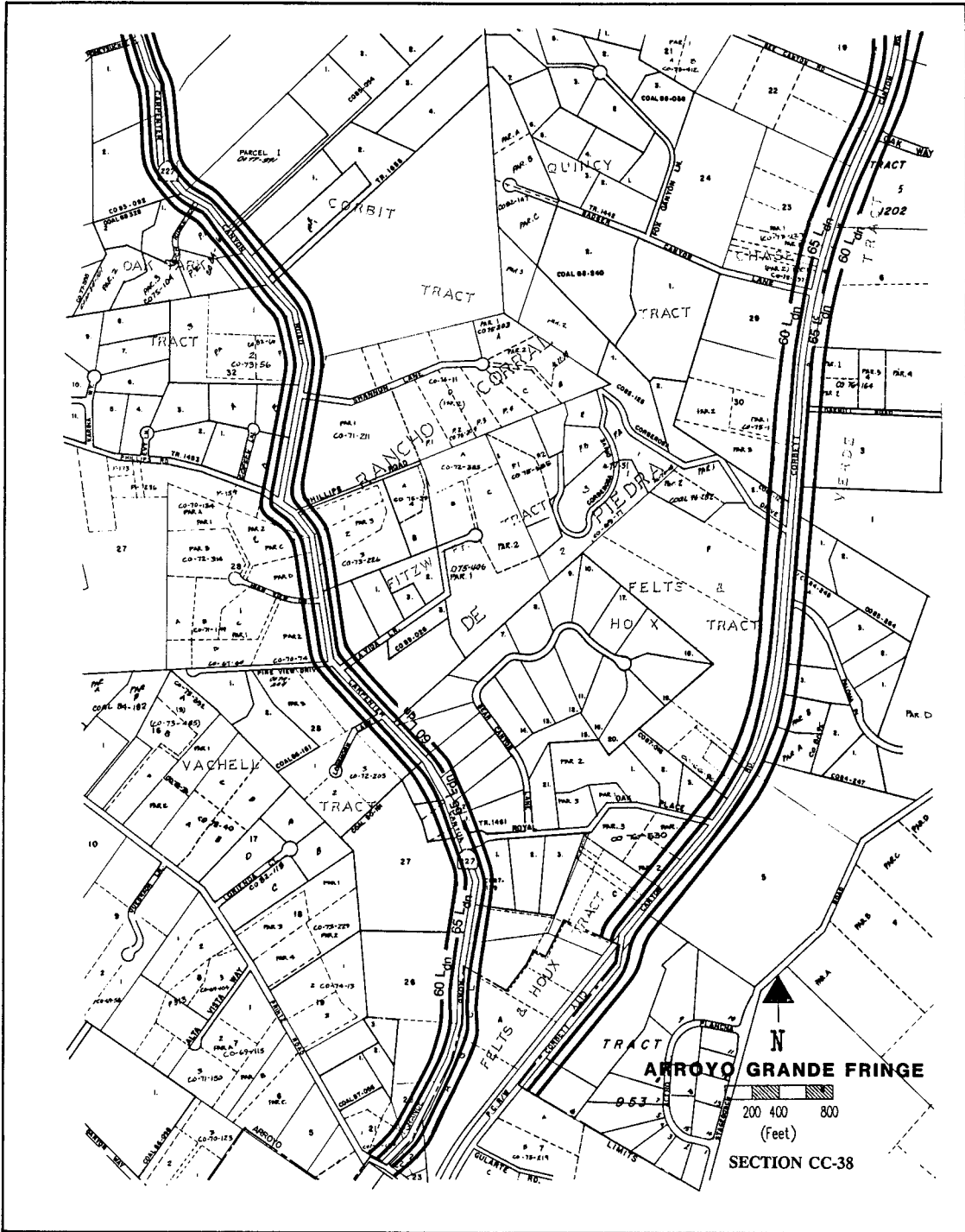

NOISE ELEMENT ■ NOISE CONTOUR MAP

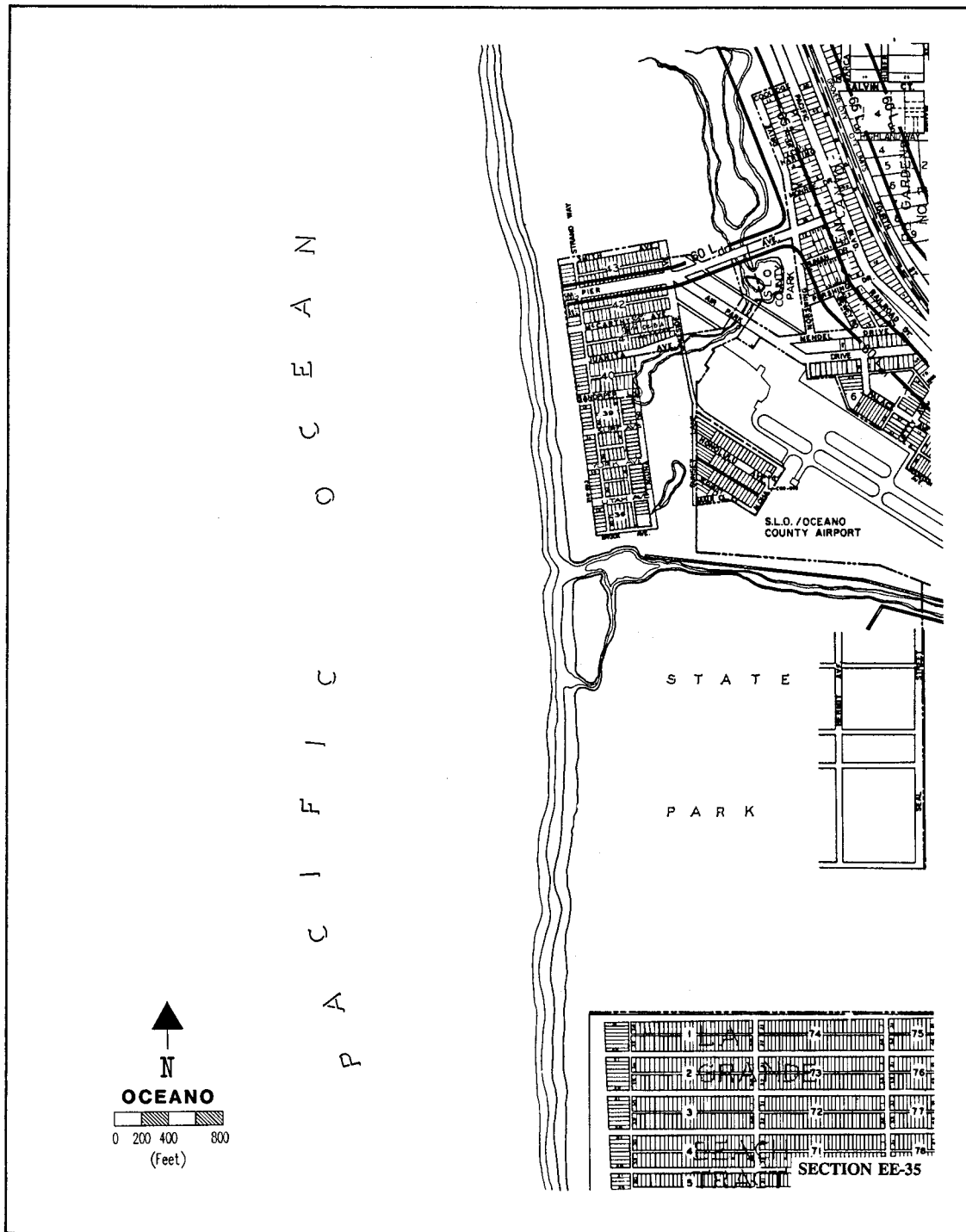

NOISE ELEMENT ■ NOISE CONTOUR MAP

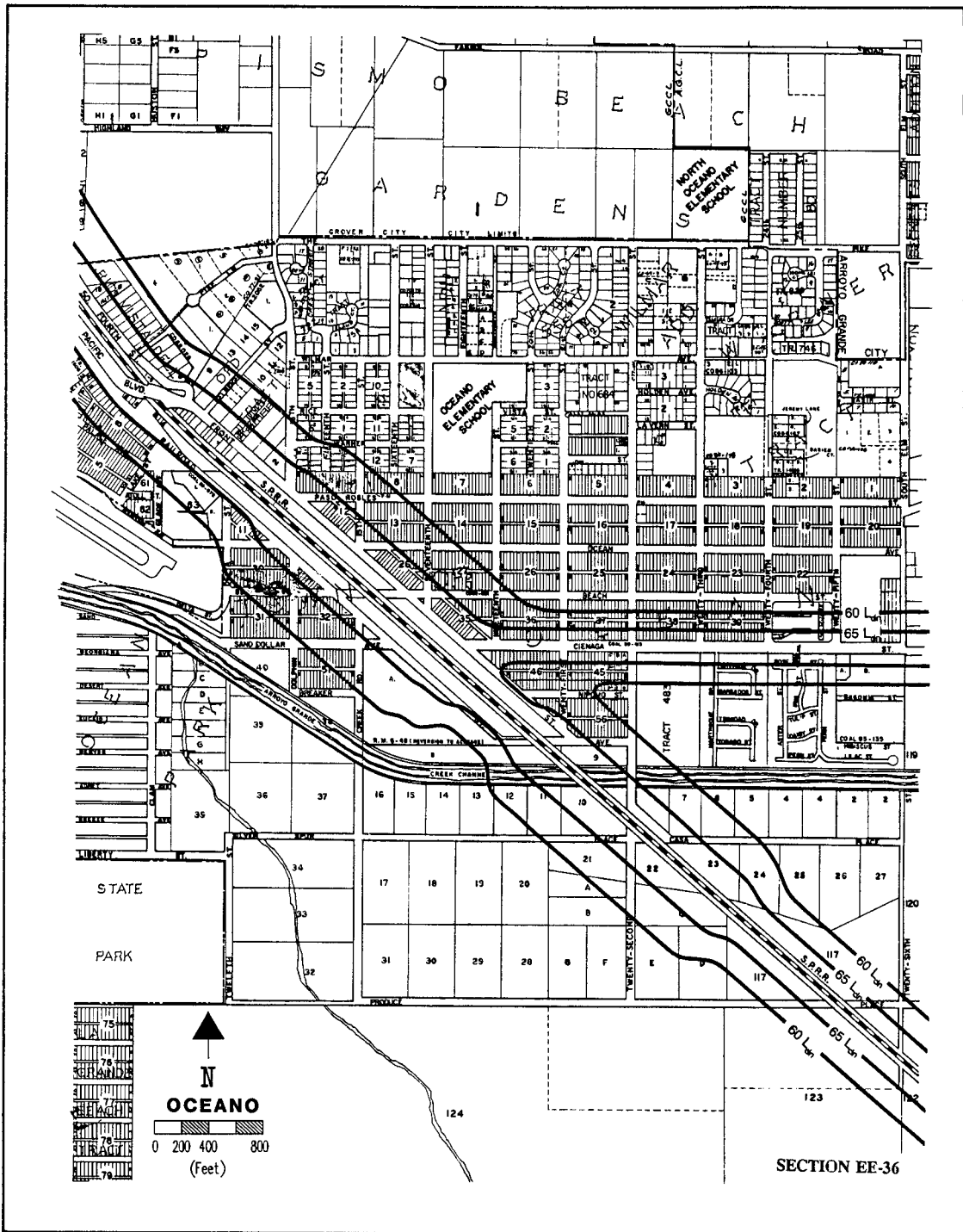

NOISE ELEMENT ■ NOISE CONTOUR MAP

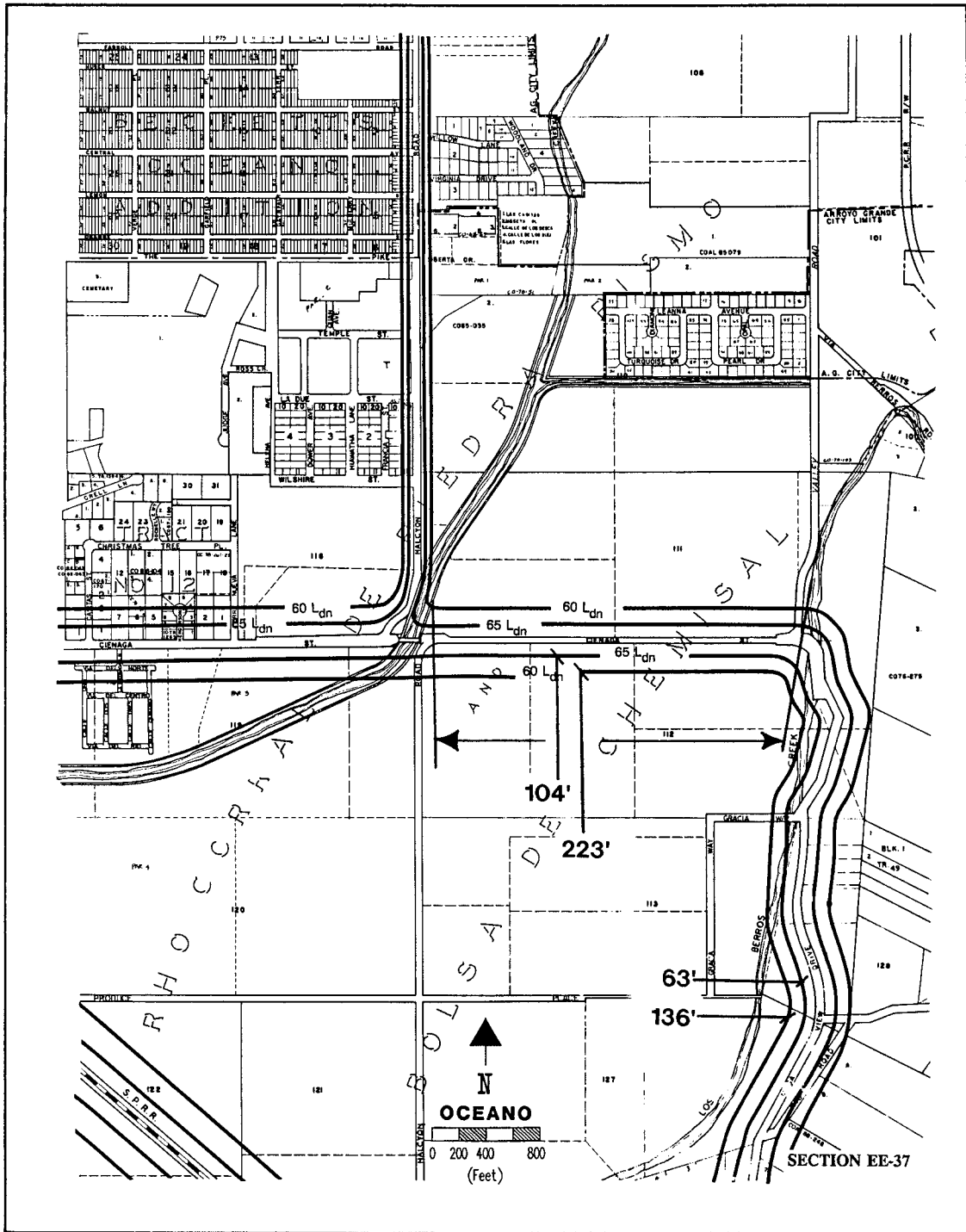

NOISE ELEMENT ■ NOISE CONTOUR MAP

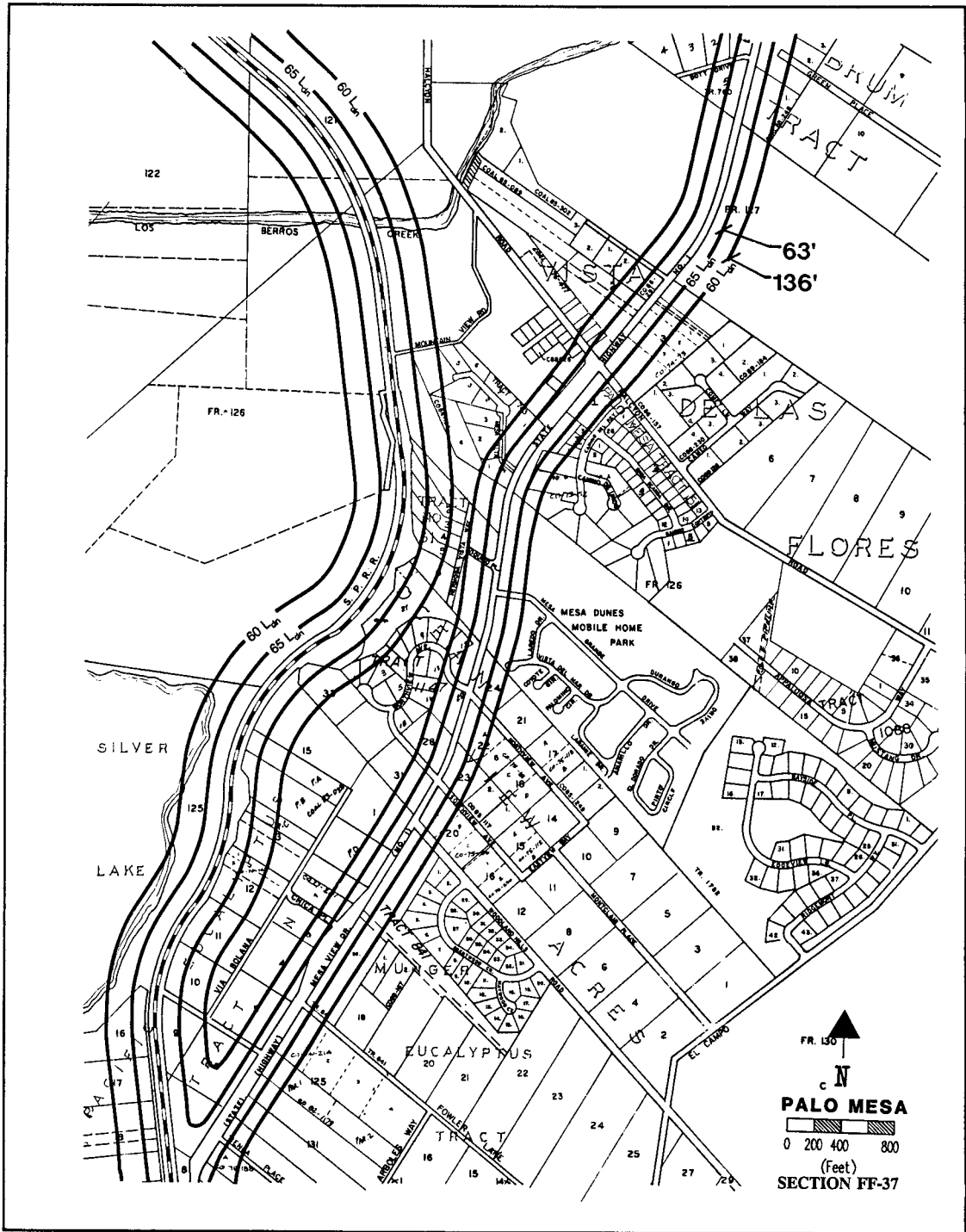

NOISE ELEMENT ■ NOISE CONTOUR MAP

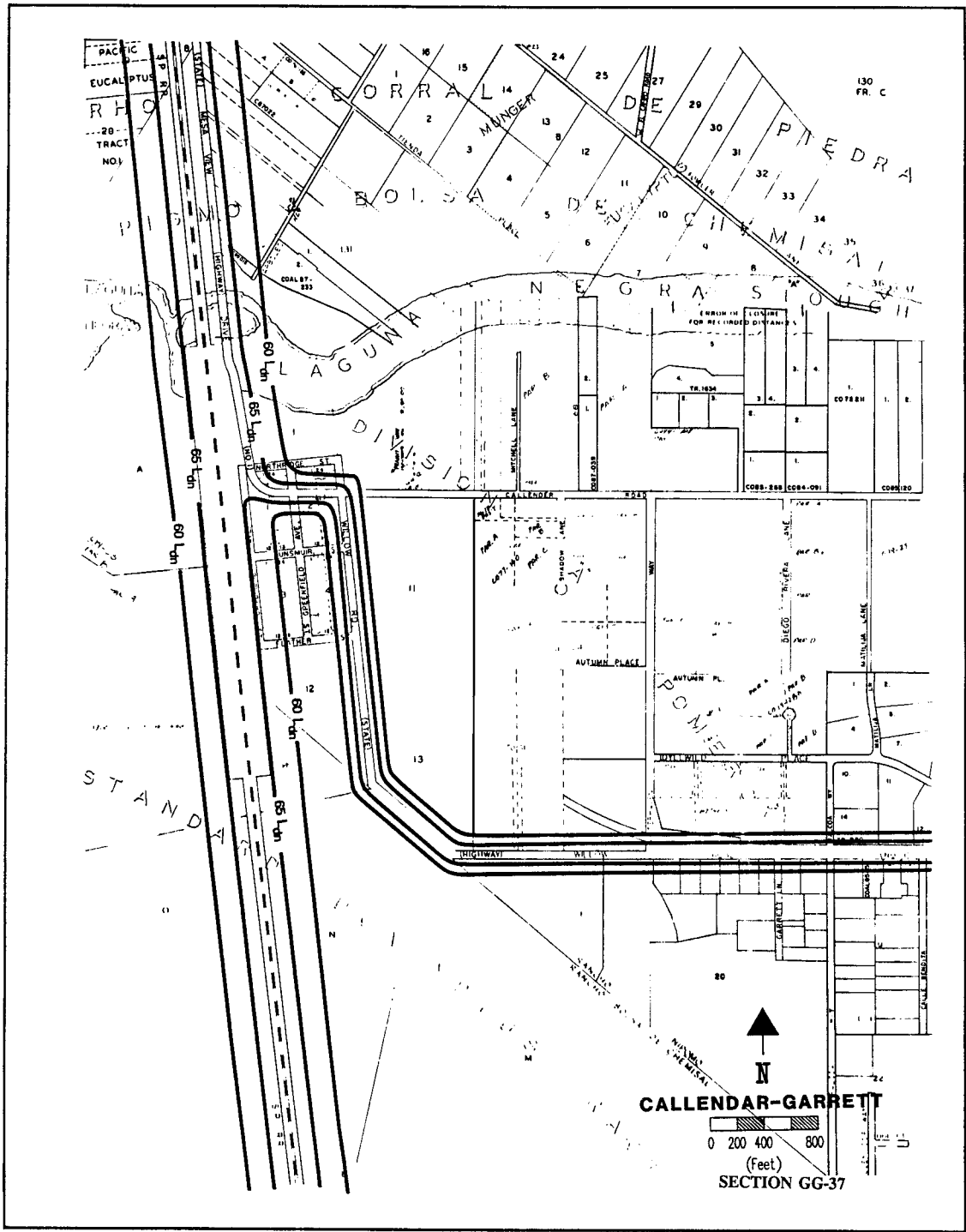

NOISE ELEMENT ■ NOISE CONTOUR MAP

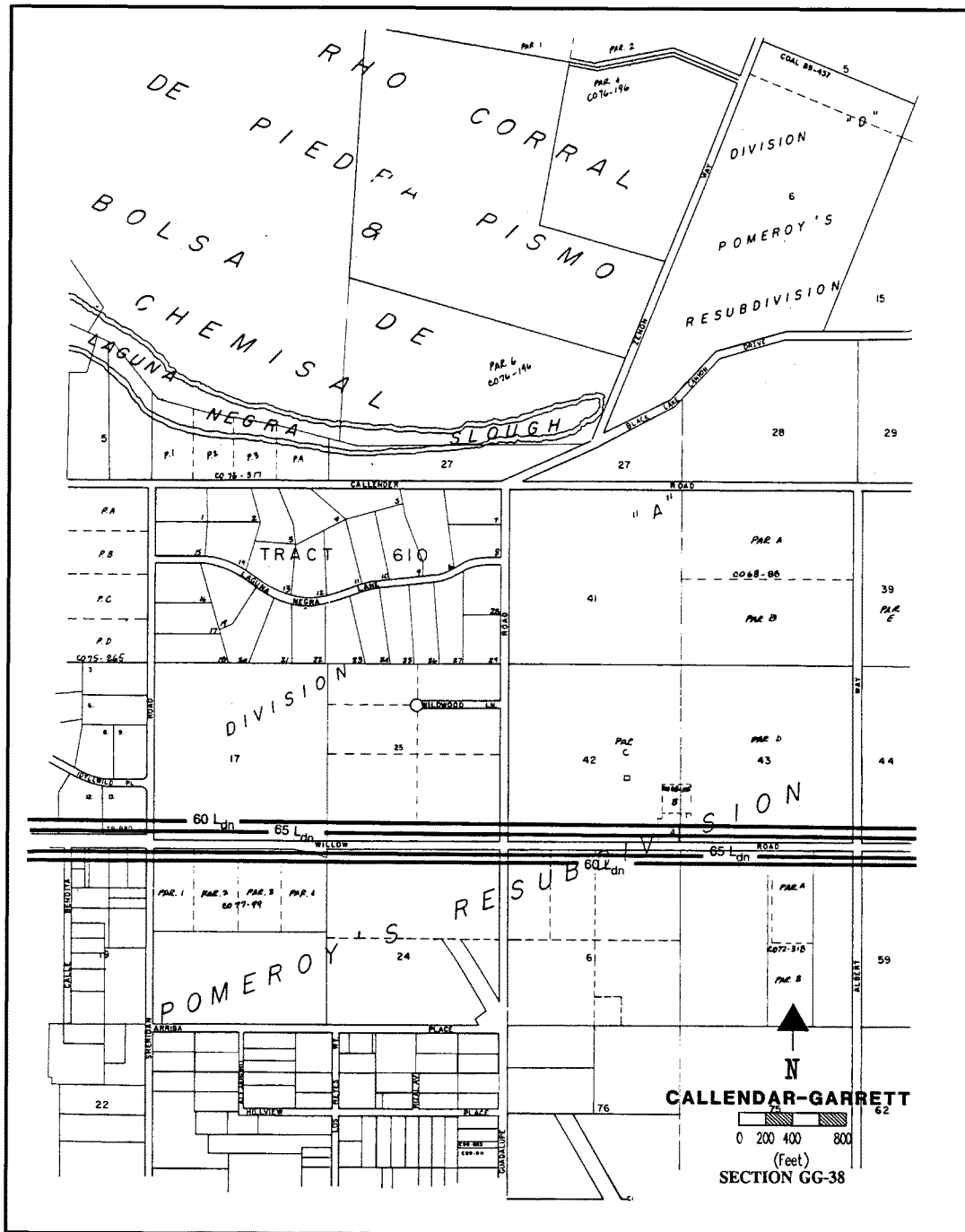

NOISE ELEMENT ■ NOISE CONTOUR MAP

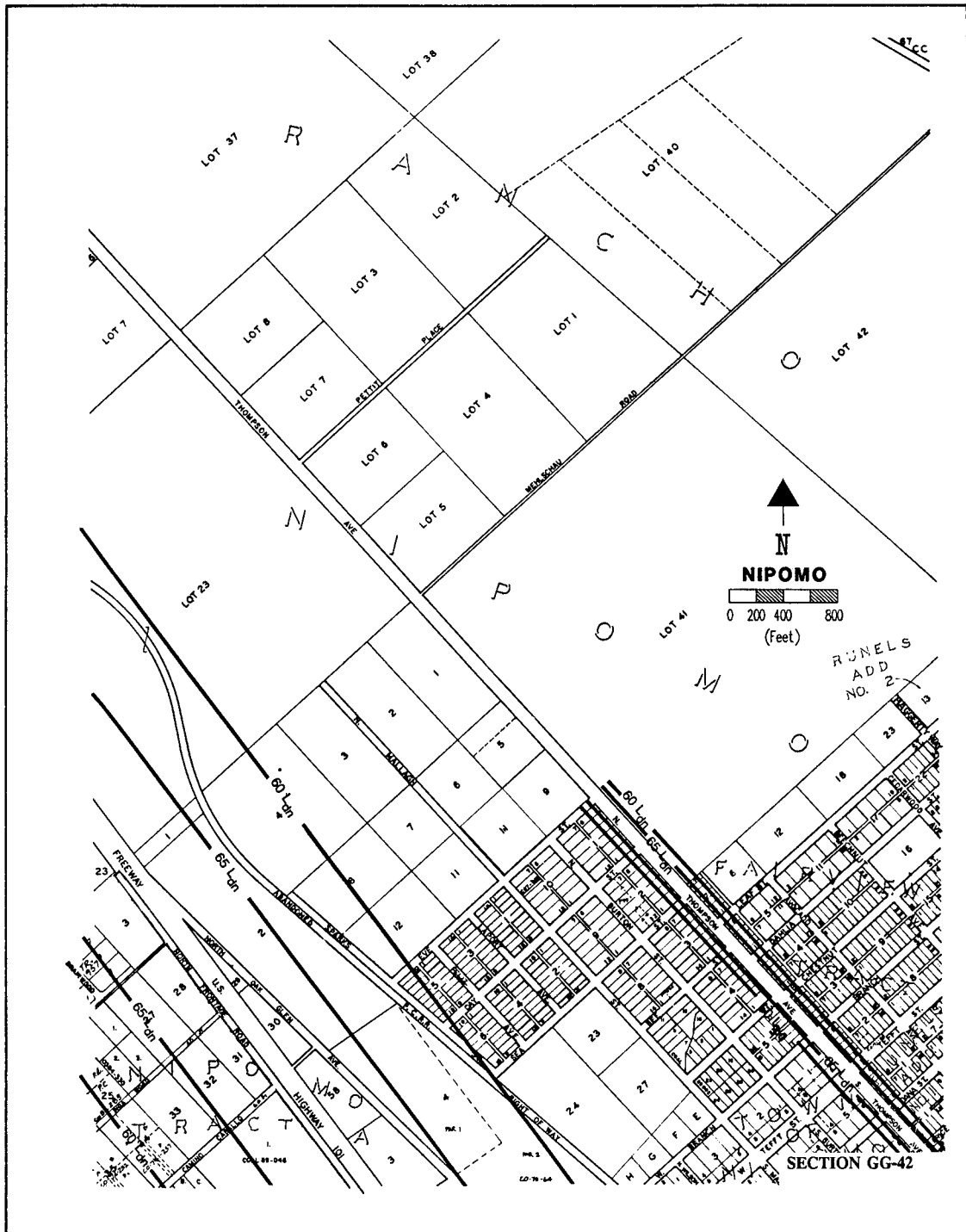

NOISE ELEMENT ■ NOISE CONTOUR MAP

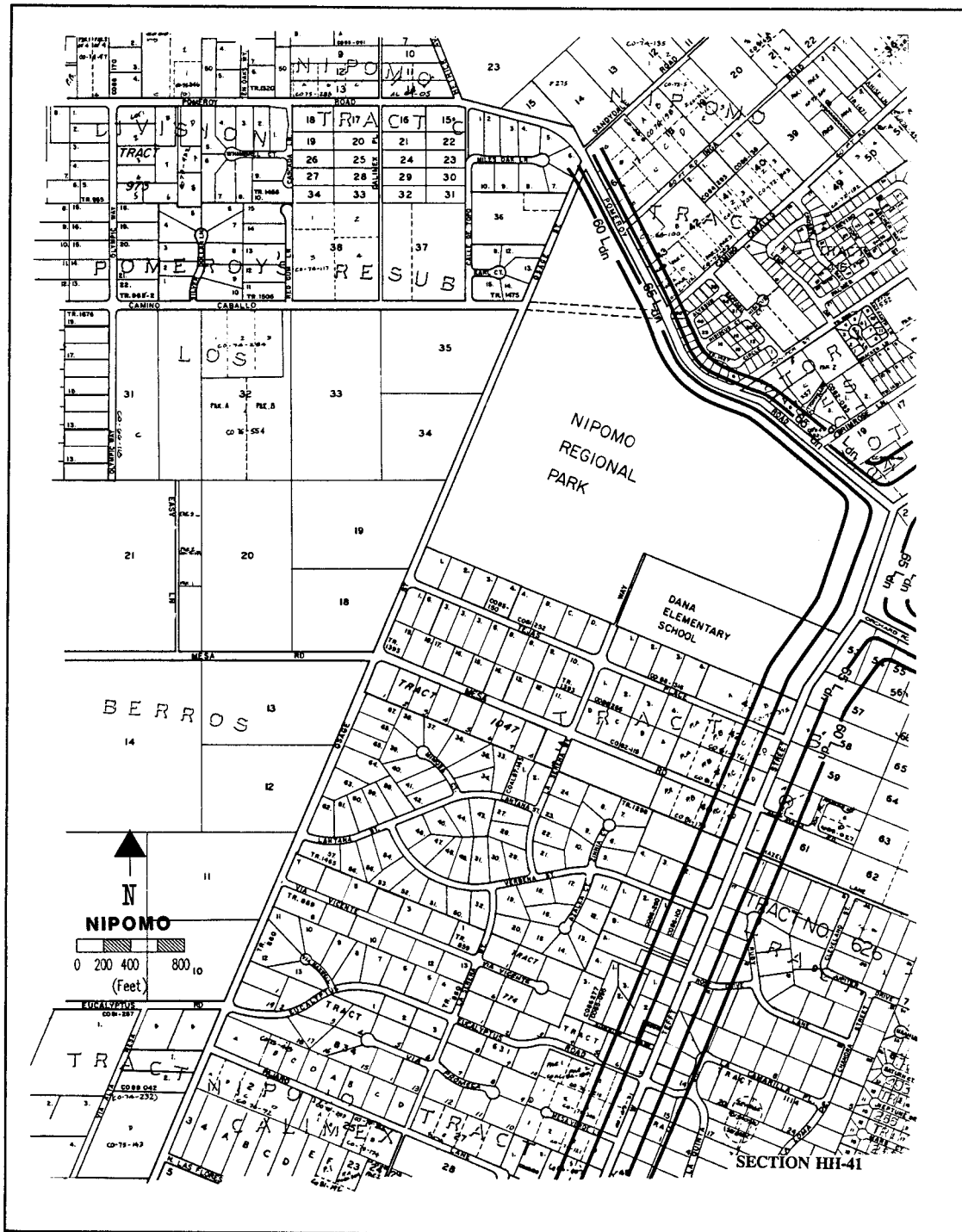

NOISE ELEMENT ■ NOISE CONTOUR MAP

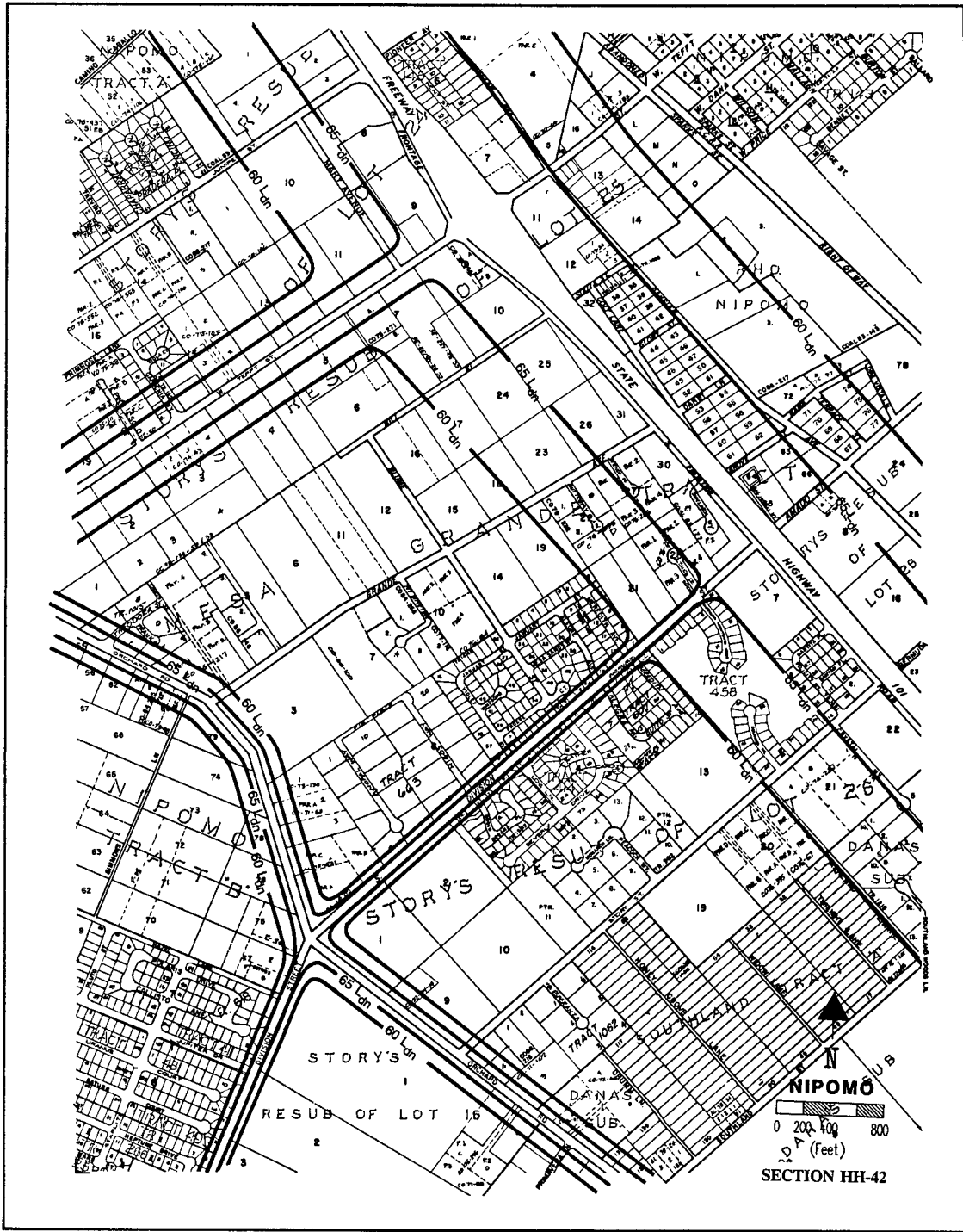

NOISE ELEMENT ■ NOISE CONTOUR MAP

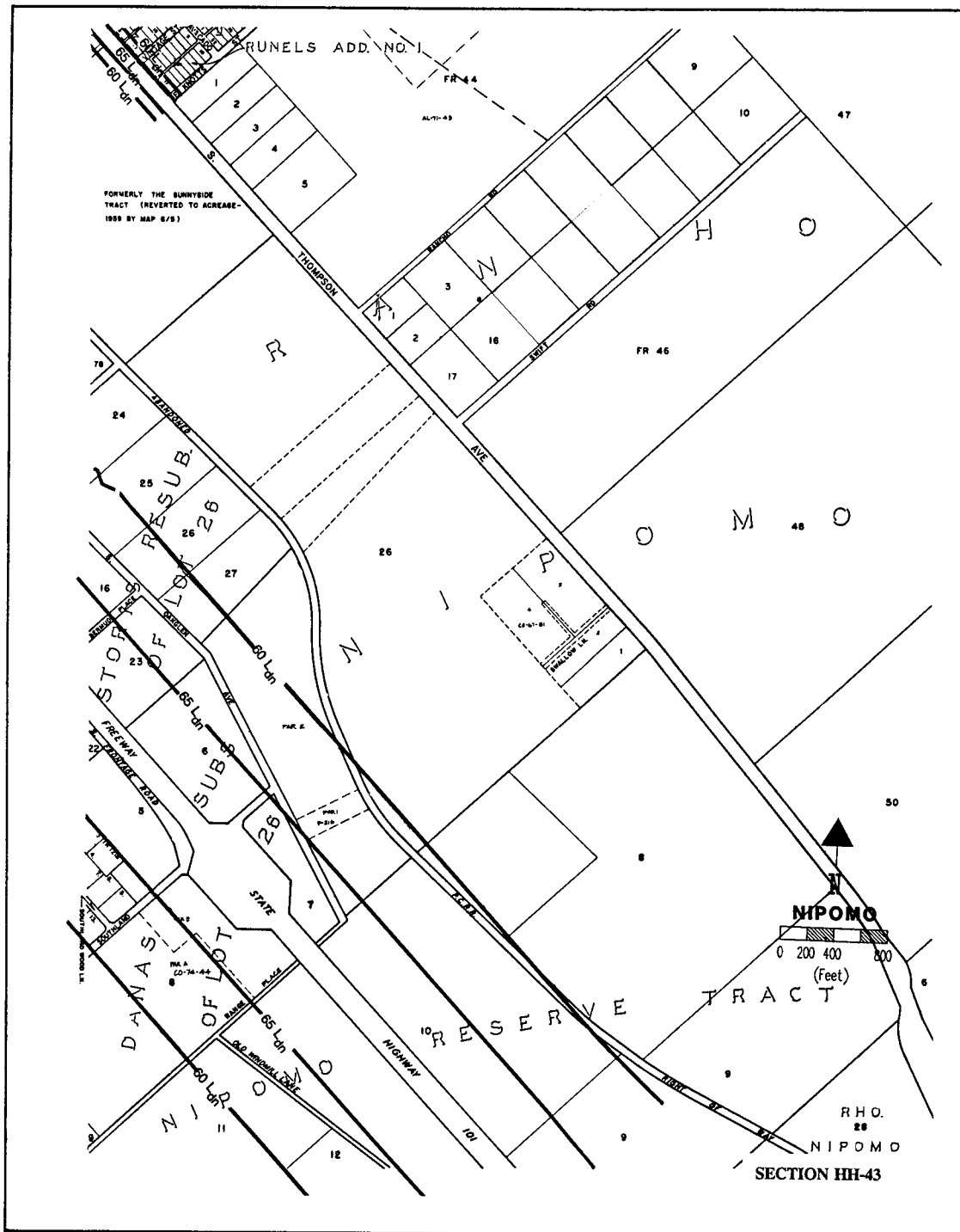

NOISE ELEMENT ■ NOISE CONTOUR MAP

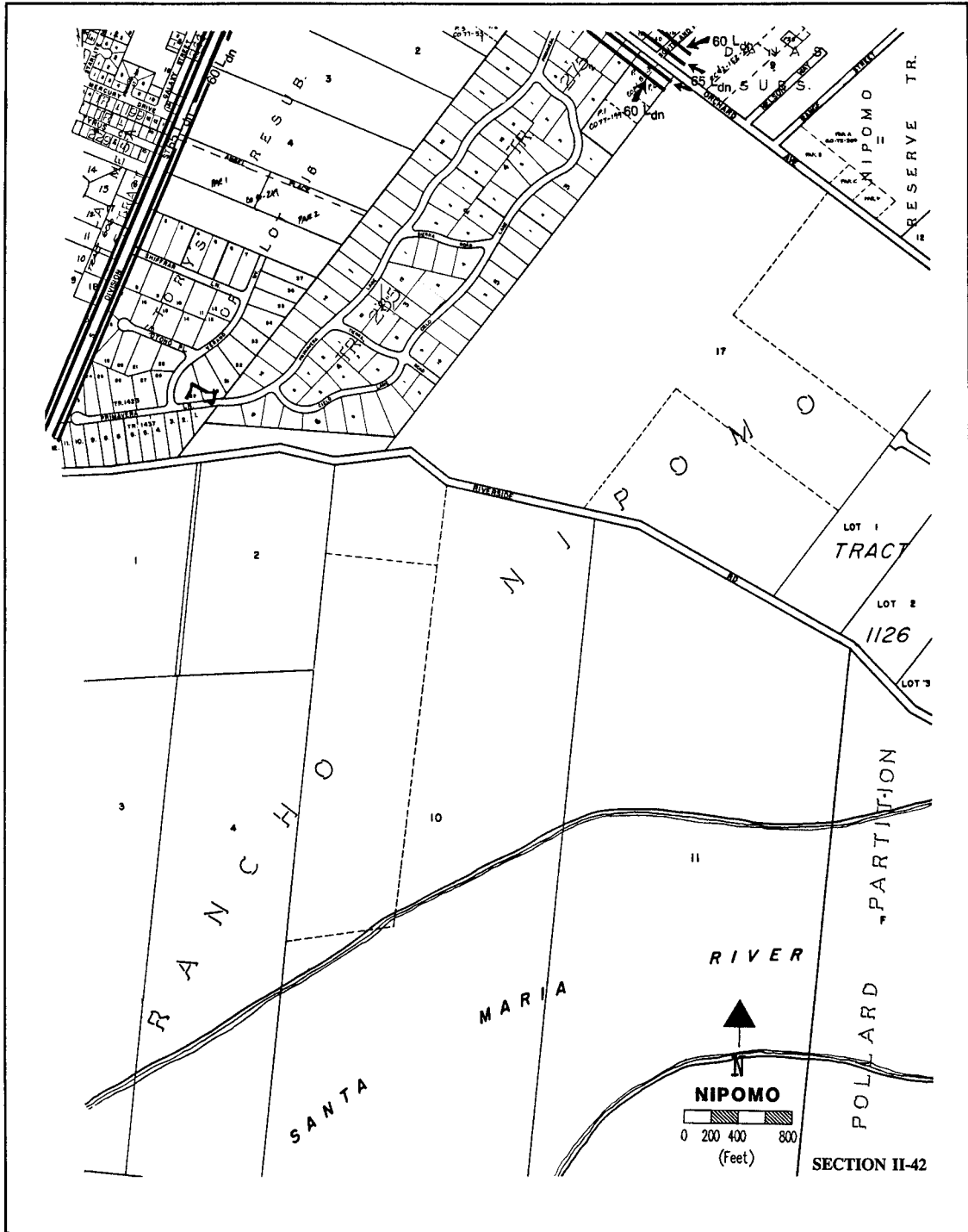

NOISE ELEMENT ■ NOISE CONTOUR MAP

**APPENDIX B: NOISE CONTOUR MAPS -
STATIONARY NOISE
SOURCES (1990)**

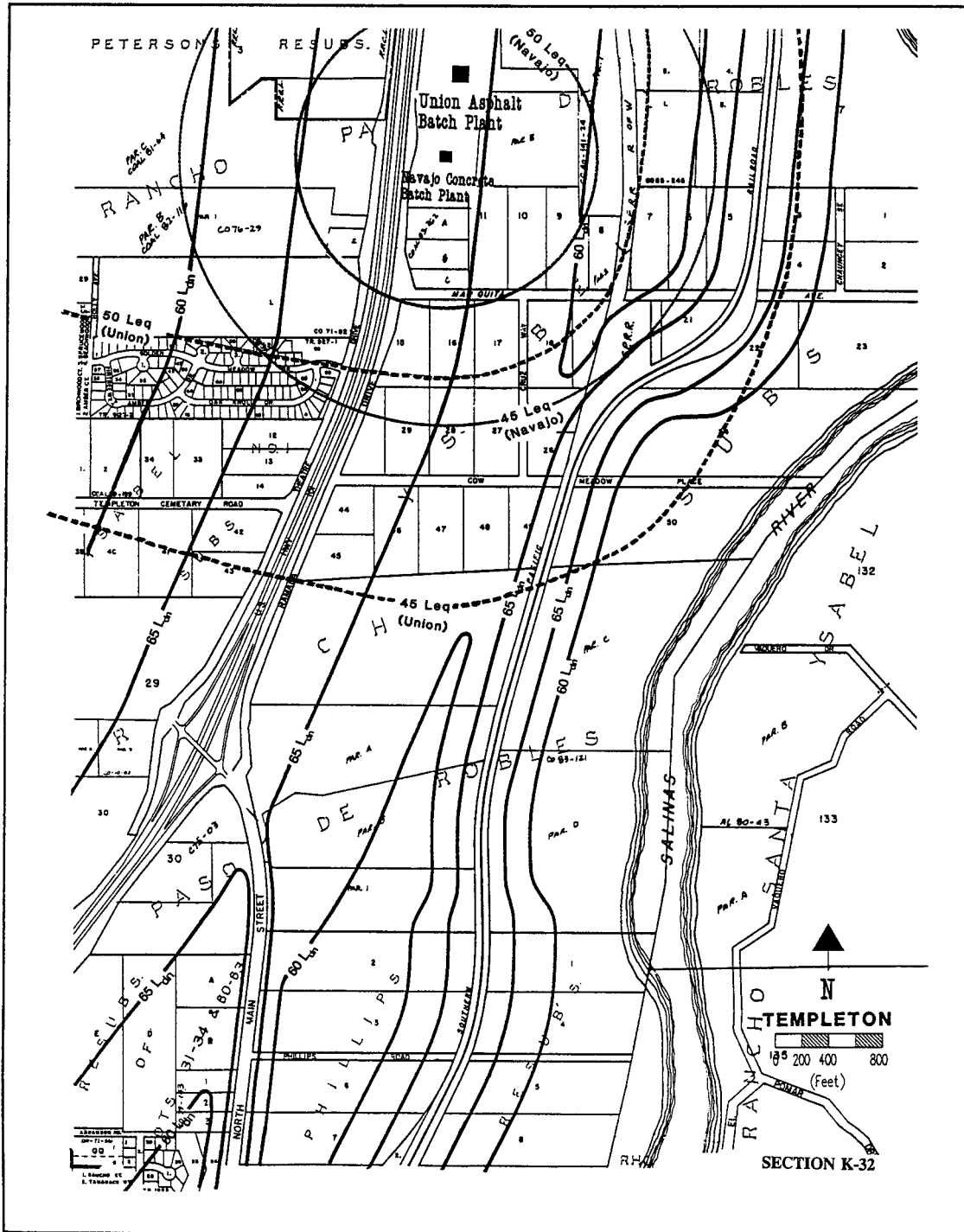

**1990 NOISE CONTOURS
UNION ASPHALT, NAVAHO CONCRETE BATCH PLANTS**

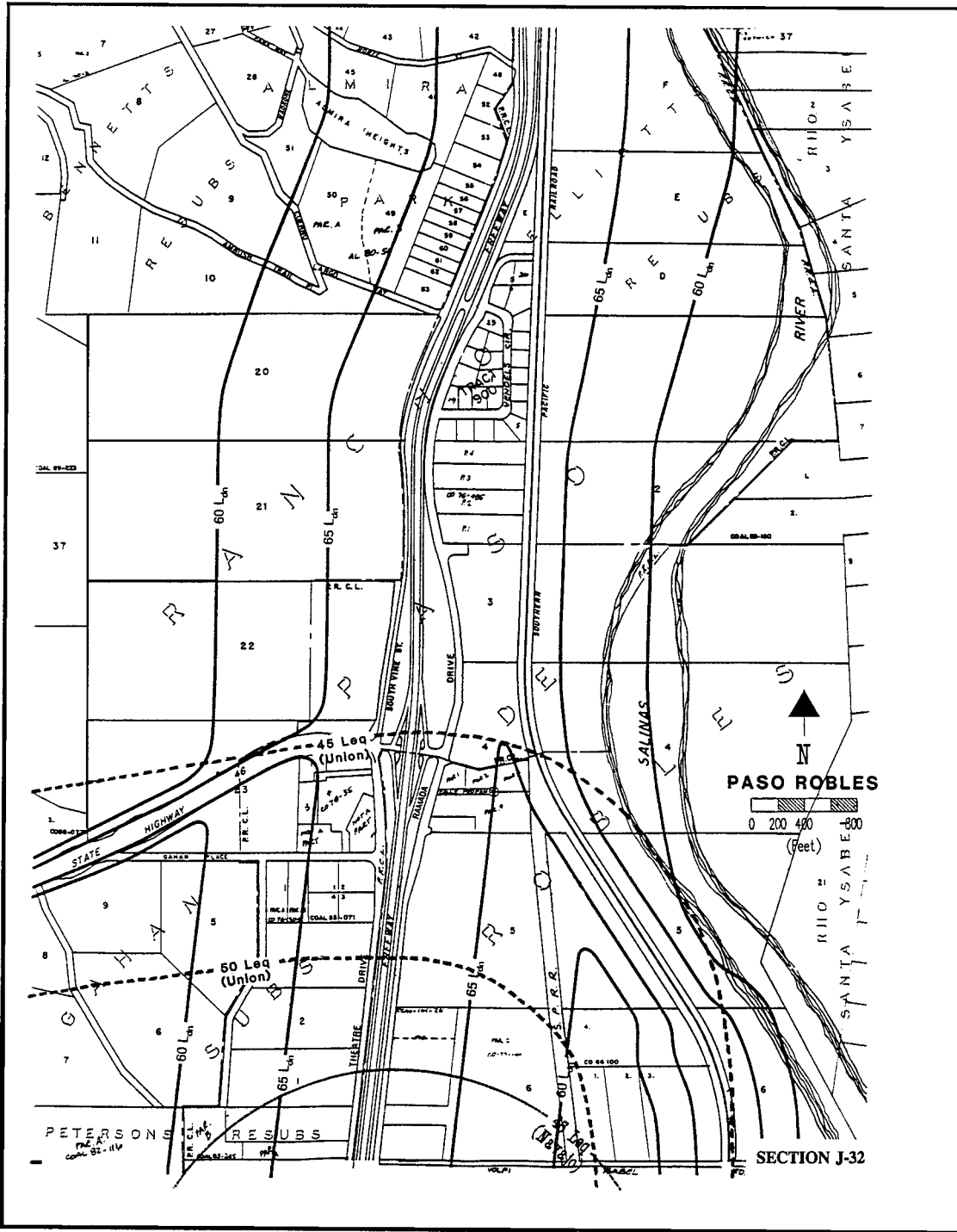

**1990 NOISE CONTOURS
UNION ASPHALT, NAVAHO CONCRETE BATCH PLANTS**

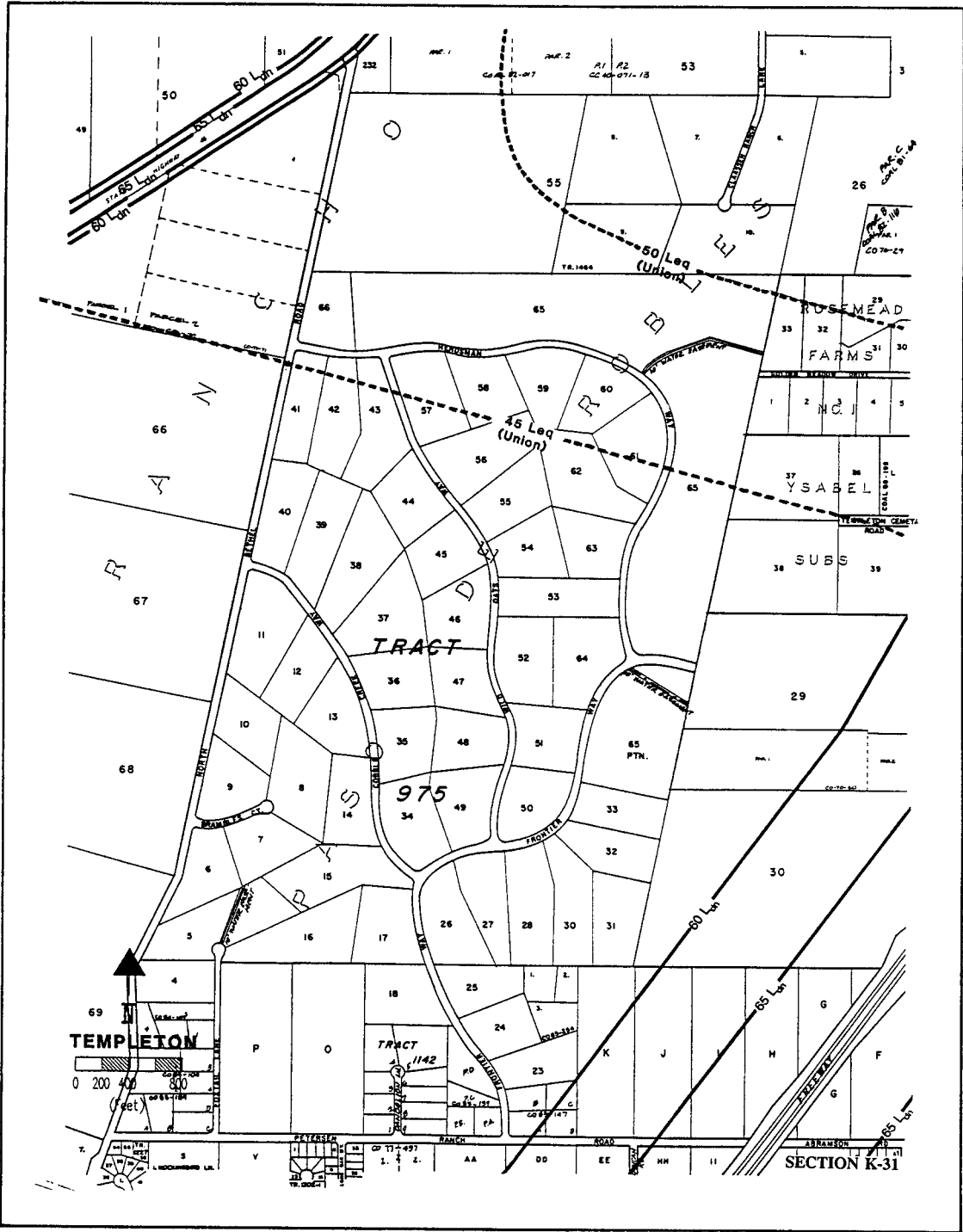

**1990 NOISE CONTOURS
UNION ASPHALT BATCH PLANT**

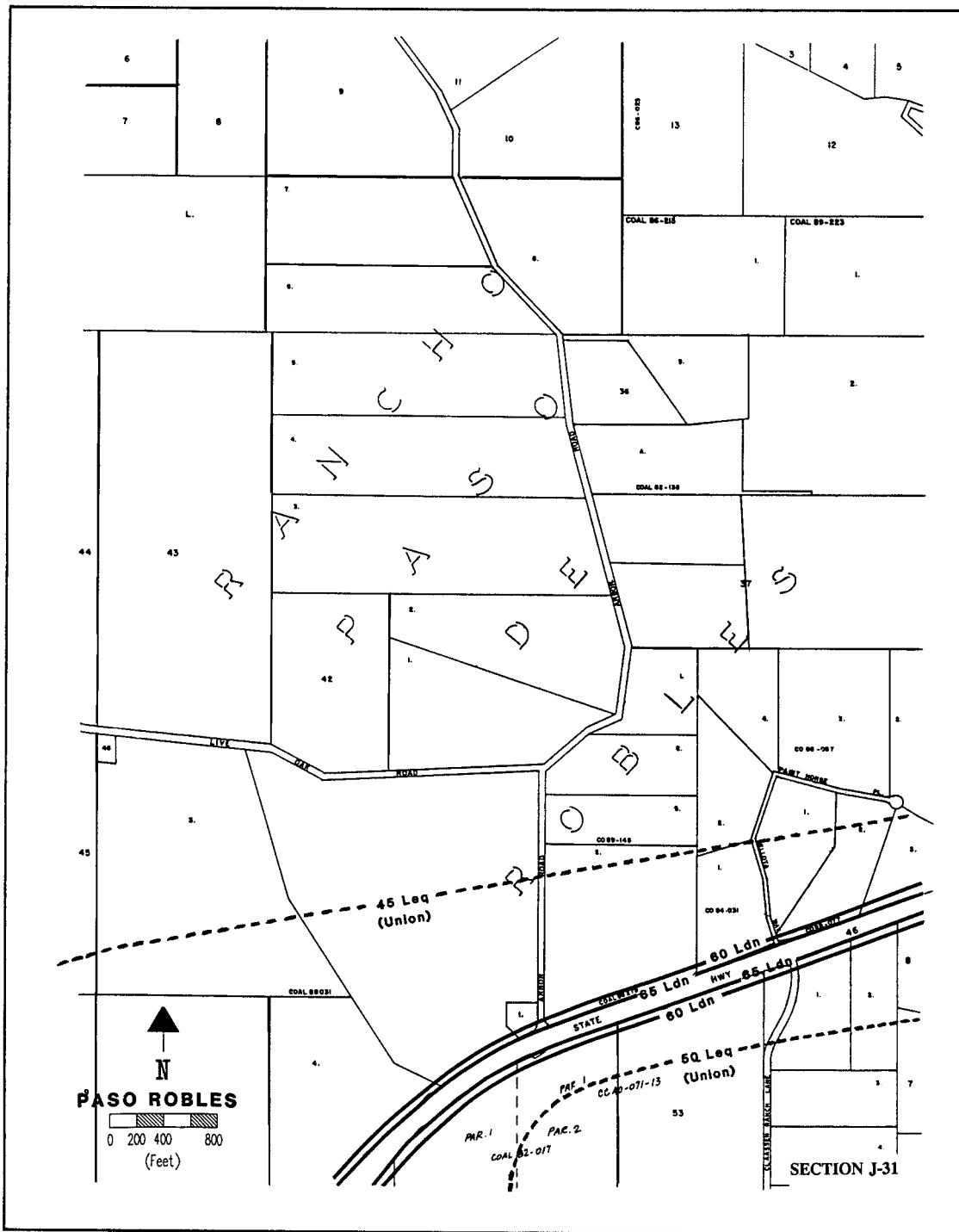

**1990 NOISE CONTOURS
UNION ASPHALT BATCH PLANT**

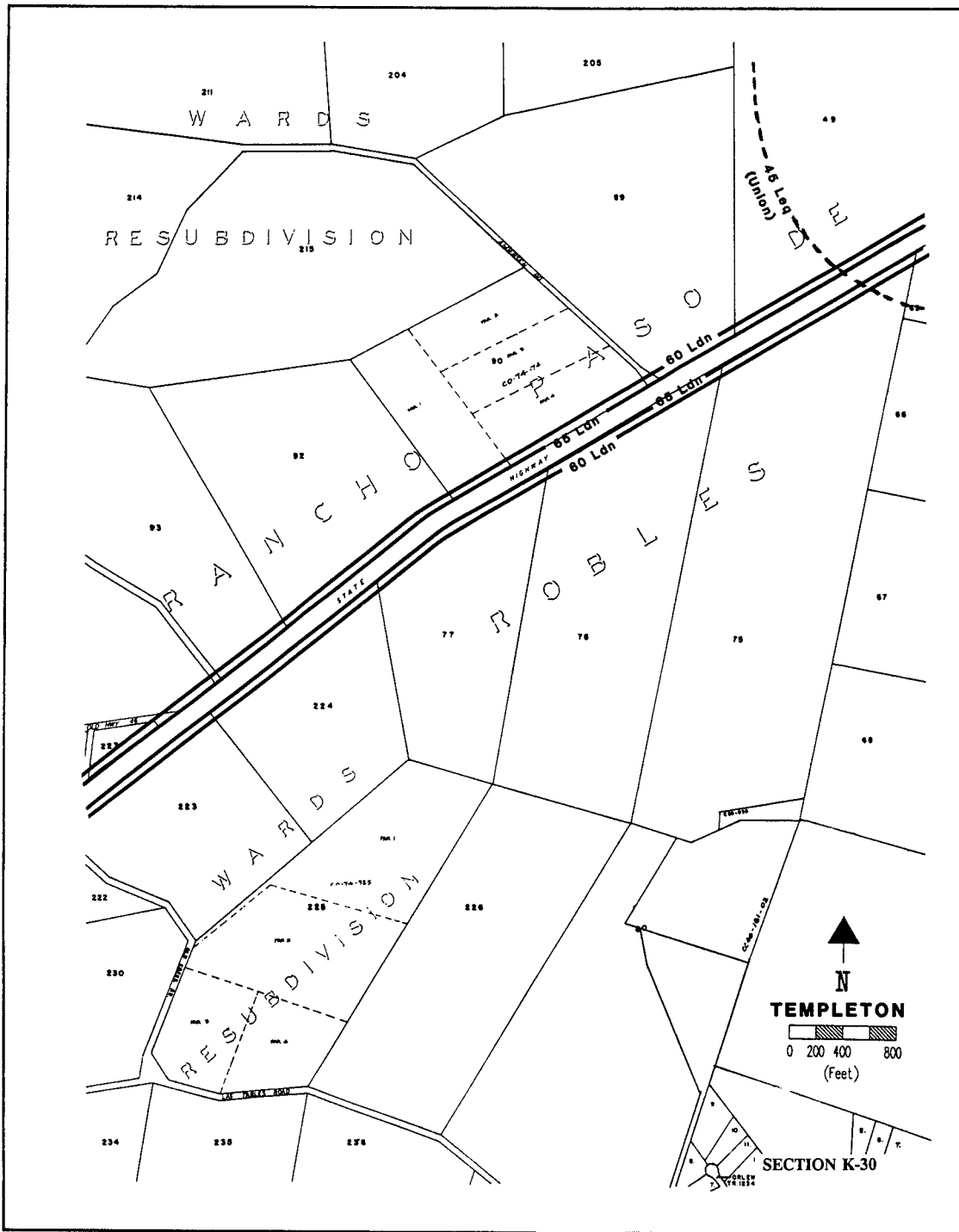

**1990 NOISE CONTOURS
UNION ASPHALT BATCH PLANT**

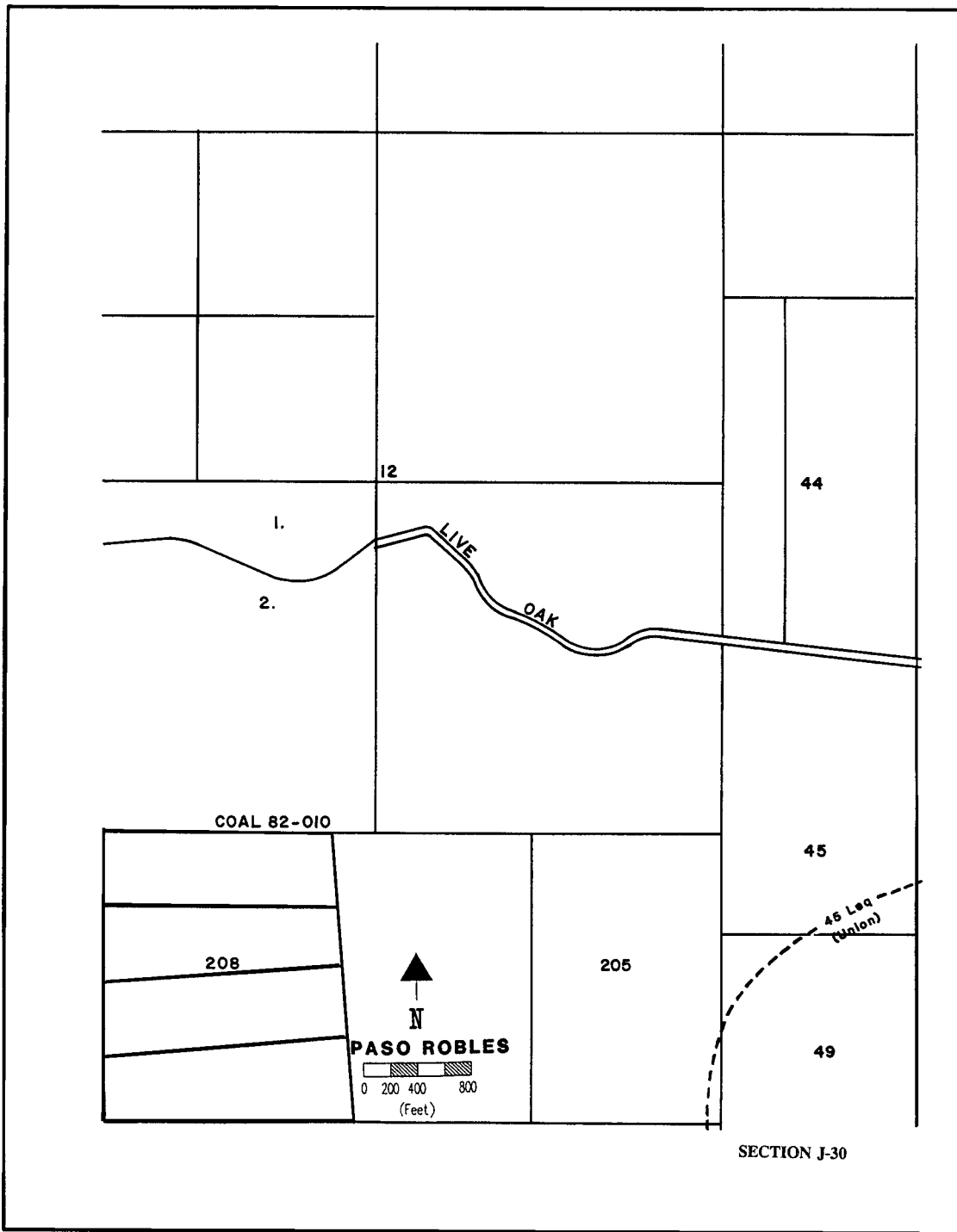

**1990 NOISE CONTOURS
UNION ASPHALT BATCH PLANT**

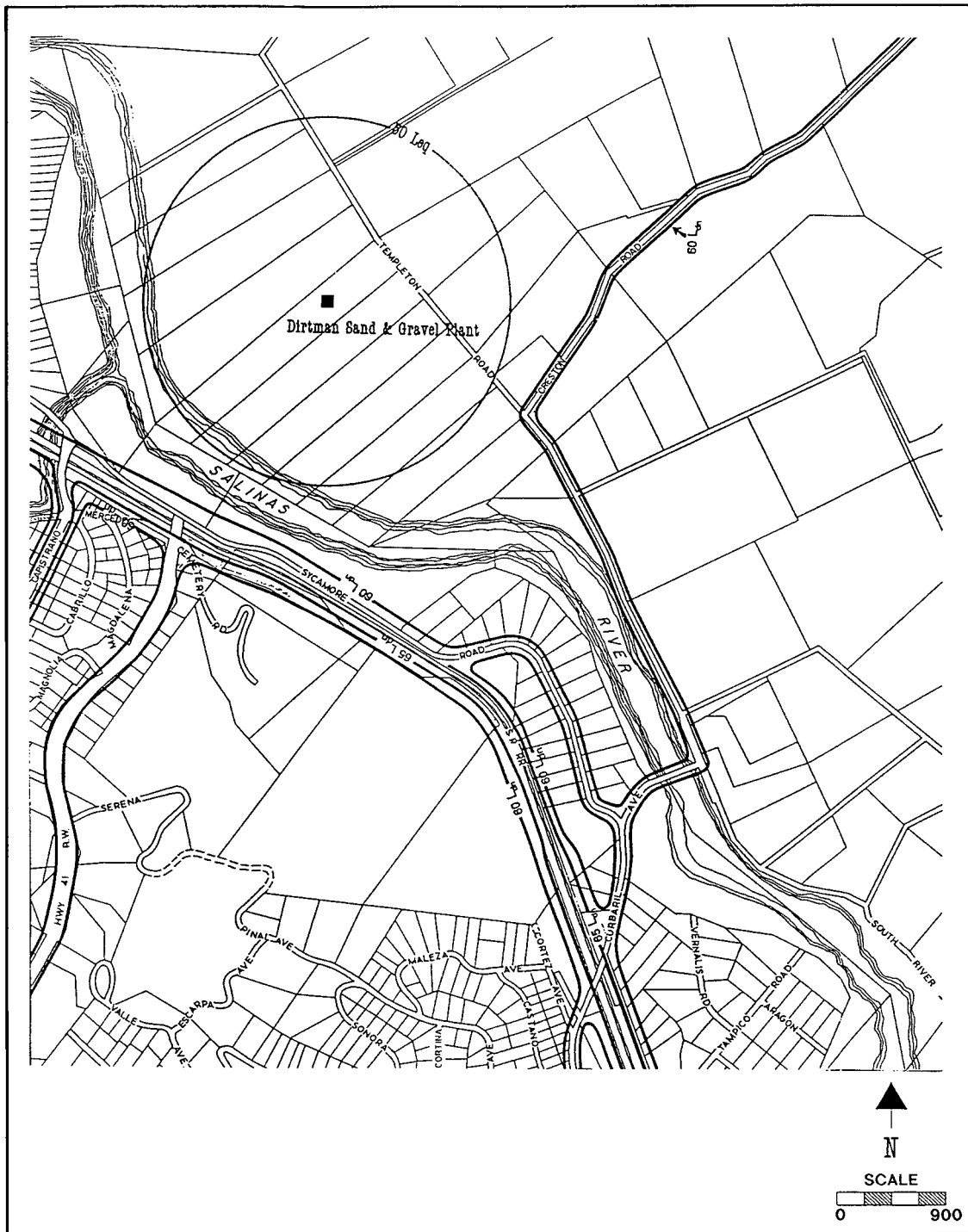

**1990 NOISE CONTOURS
DIRTMAN SAND & GRAVEL PLANT, EAST OF ATASCADERO**

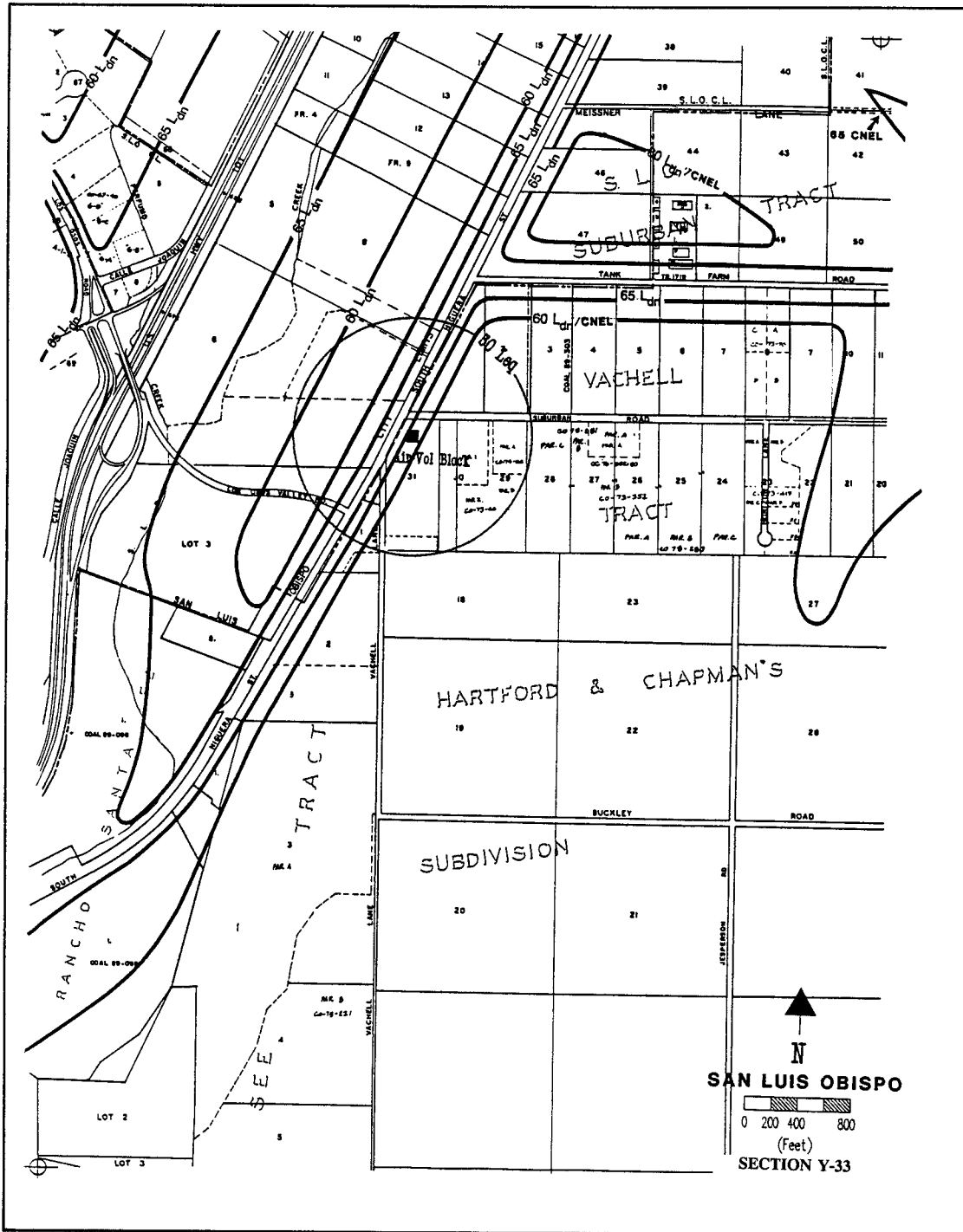

**1990 NOISE CONTOURS
 AIR VOL BLOCK CONCRETE BLOCK MANUFACTURING,
 SOUTH OF SAN LUIS OBISPO**

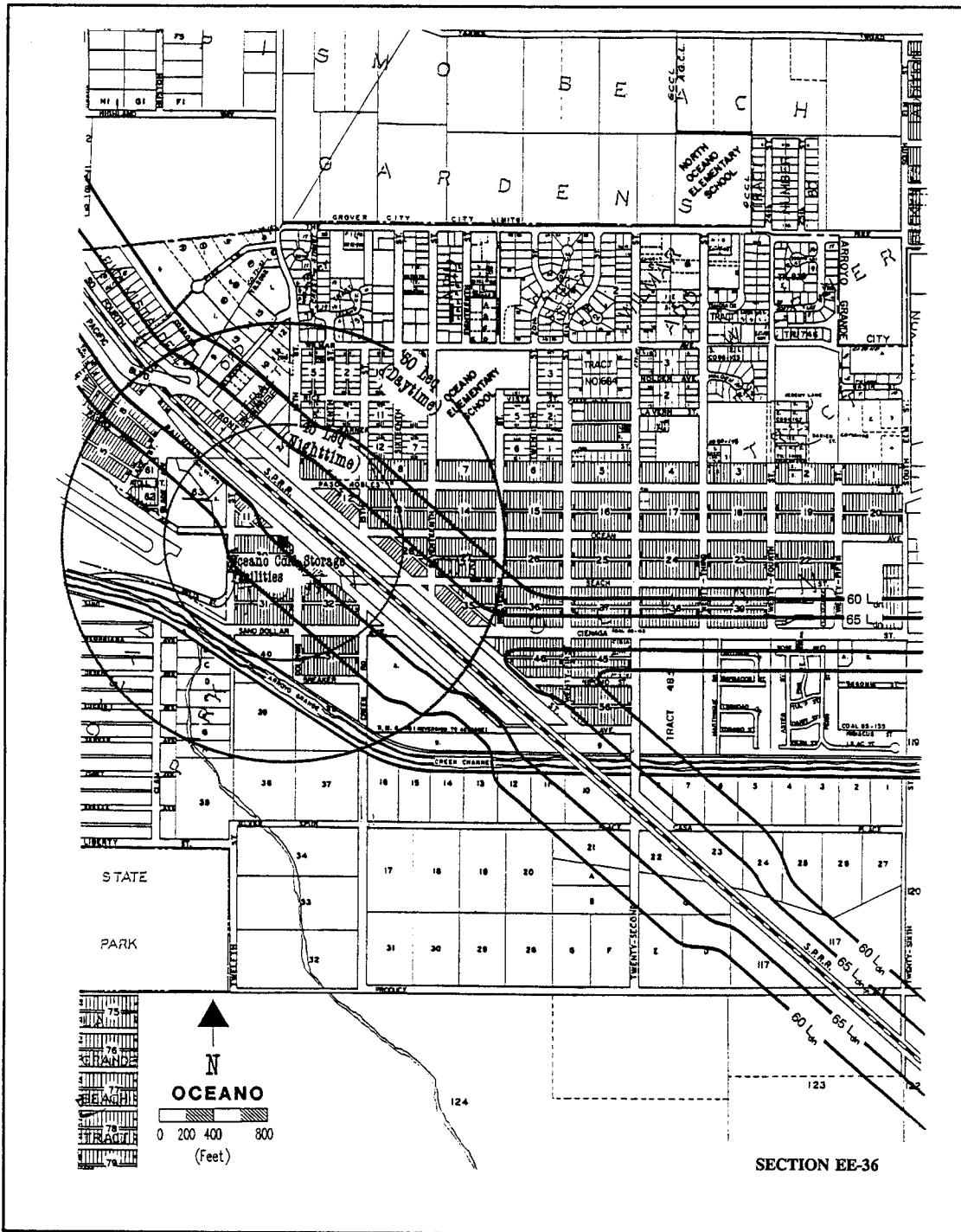

**1990 NOISE CONTOURS
 COLD STORAGE FACILITIES: OCEANO ICE CO., PHELAN & TAYLOR,
 OCEANO PACKING PLANT**

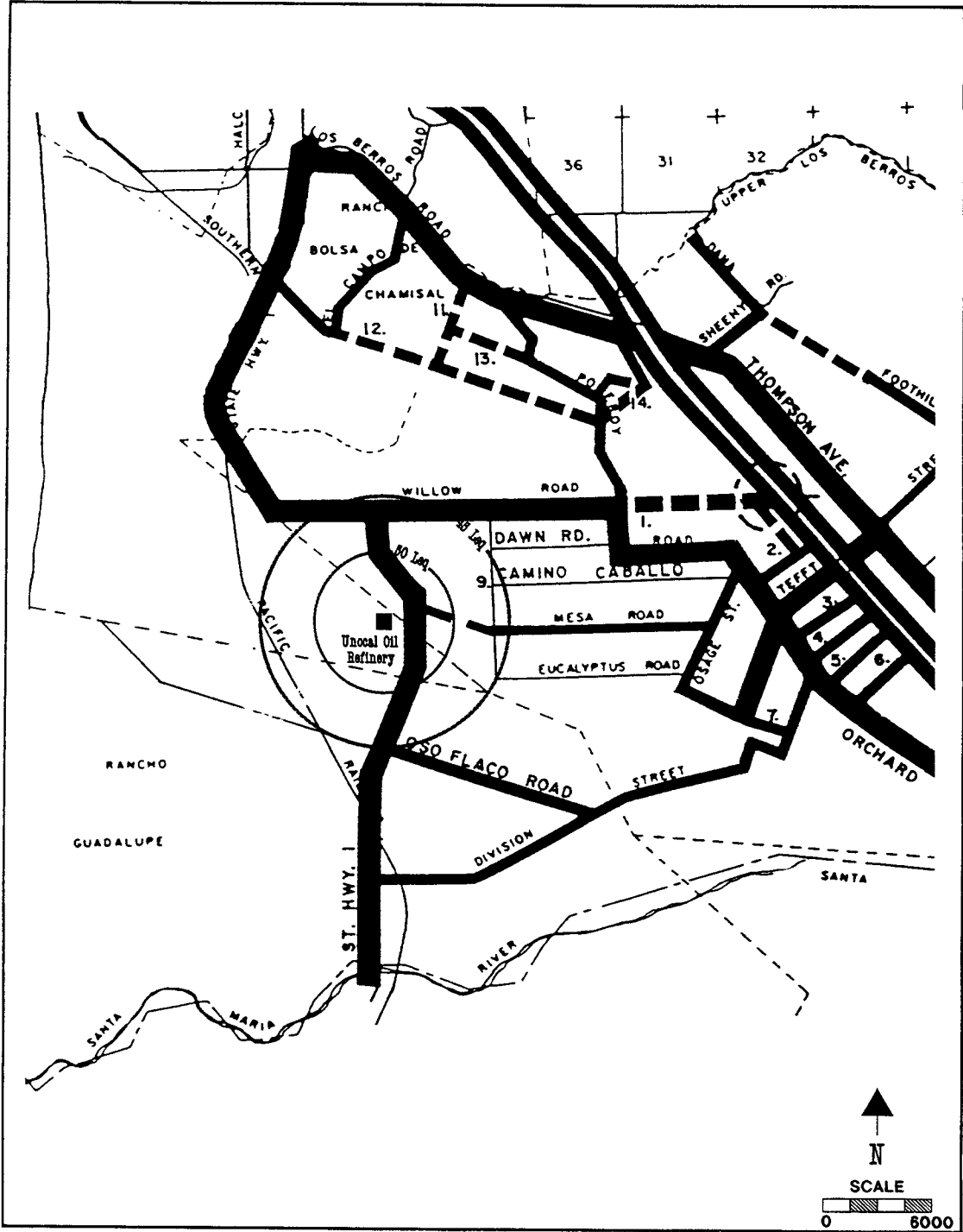

**1990 NOISE CONTOURS
UNOCAL OIL REFINERY, WEST OF HWY. 1, NEAR CALLENDER-GARRETT**

APPENDIX C: NOISE CONTOUR MAPS - FUTURE CNEL CONTOURS FOR PASO ROBLES MUNICIPAL AIRPORT, OCEANO, AND SAN LUIS OBISPO COUNTY AIRPORTS

Paso Robles Municipal Airport:

Figure C-1 shows the 2010 CNEL contours for the maximum growth scenario. This map is thought to be representative of potential worst-case conditions at the airport, and assumes that the aircraft fleet would include approximately eight (8) percent business jet (turbo jet or turbo fan) aircraft operations. This map may be used for land use planning purposes to identify areas around the airport which could be exposed to excessive noise levels. More detailed information is available from Reference 6, Technical Reference Document.

Oceano Airport:

Figure C-2 shows the projected-future (2005) CNEL contours for the airport. Shown are noise exposure values of 45 and 50 CNEL. Such values represent lower noise exposure than the land use compatibility criteria established by the State of California or the policies of this Noise Element. For this reason, they may be used to represent a worst-case picture of noise exposure in areas around the airport which are normally subject to aircraft overflights.

San Luis Obispo County Airport:

Figure C-3 shows the CNEL 70, 65, and 60 contours for the theoretical capacity of the airport. These contours should be used as a reference for determining where potential conflicts with the policies of this Noise Element may occur as the result of existing or proposed development of noise-sensitive land uses. A more detailed discussion of the methods and data used to prepare this figure is contained within Reference 10, Technical Reference Document.

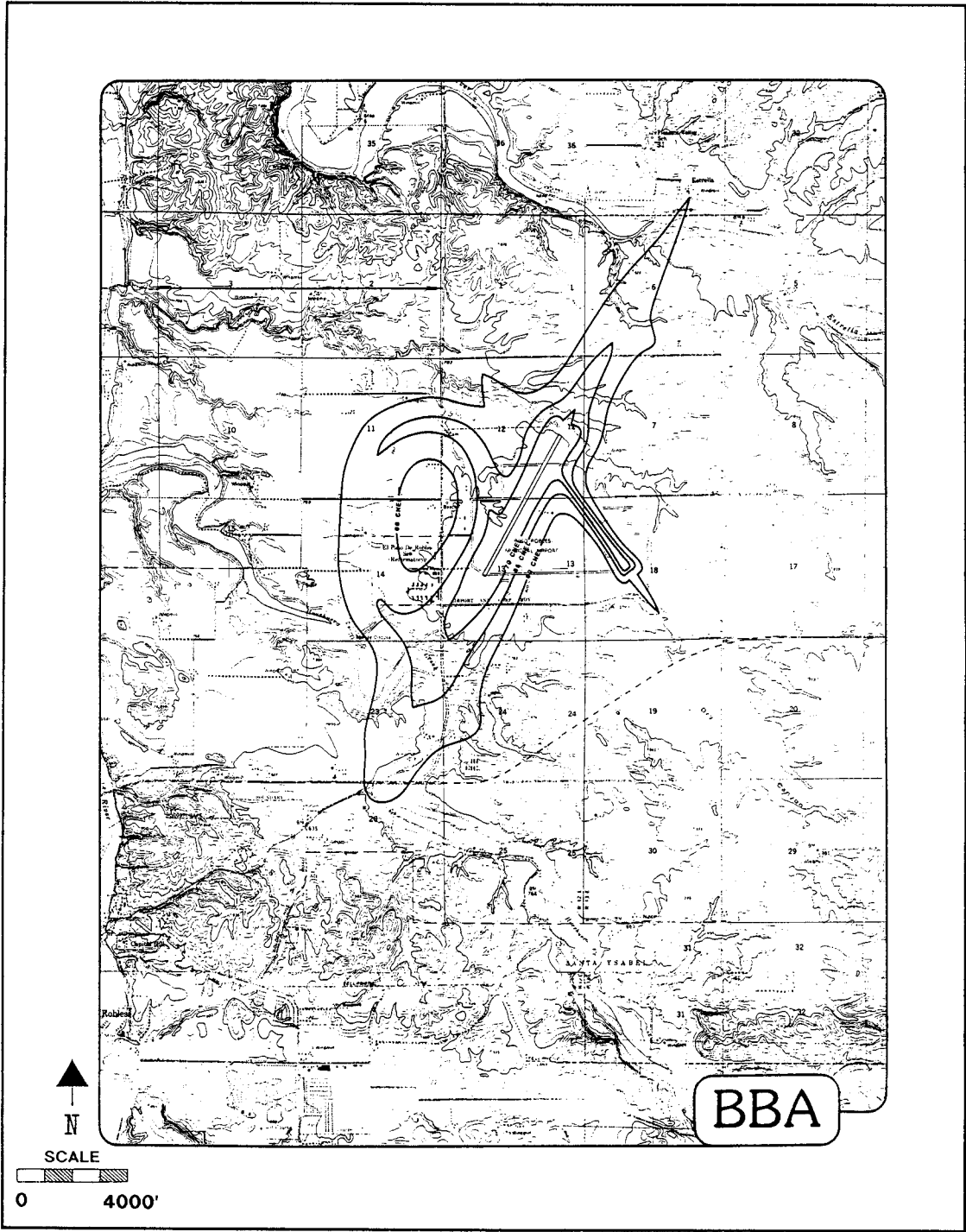

**FIGURE C-1: PASO ROBLES MUNICIPAL AIRPORT
YEAR 2010 NOISE CONTOURS (MAXIMUM FORECAST)**

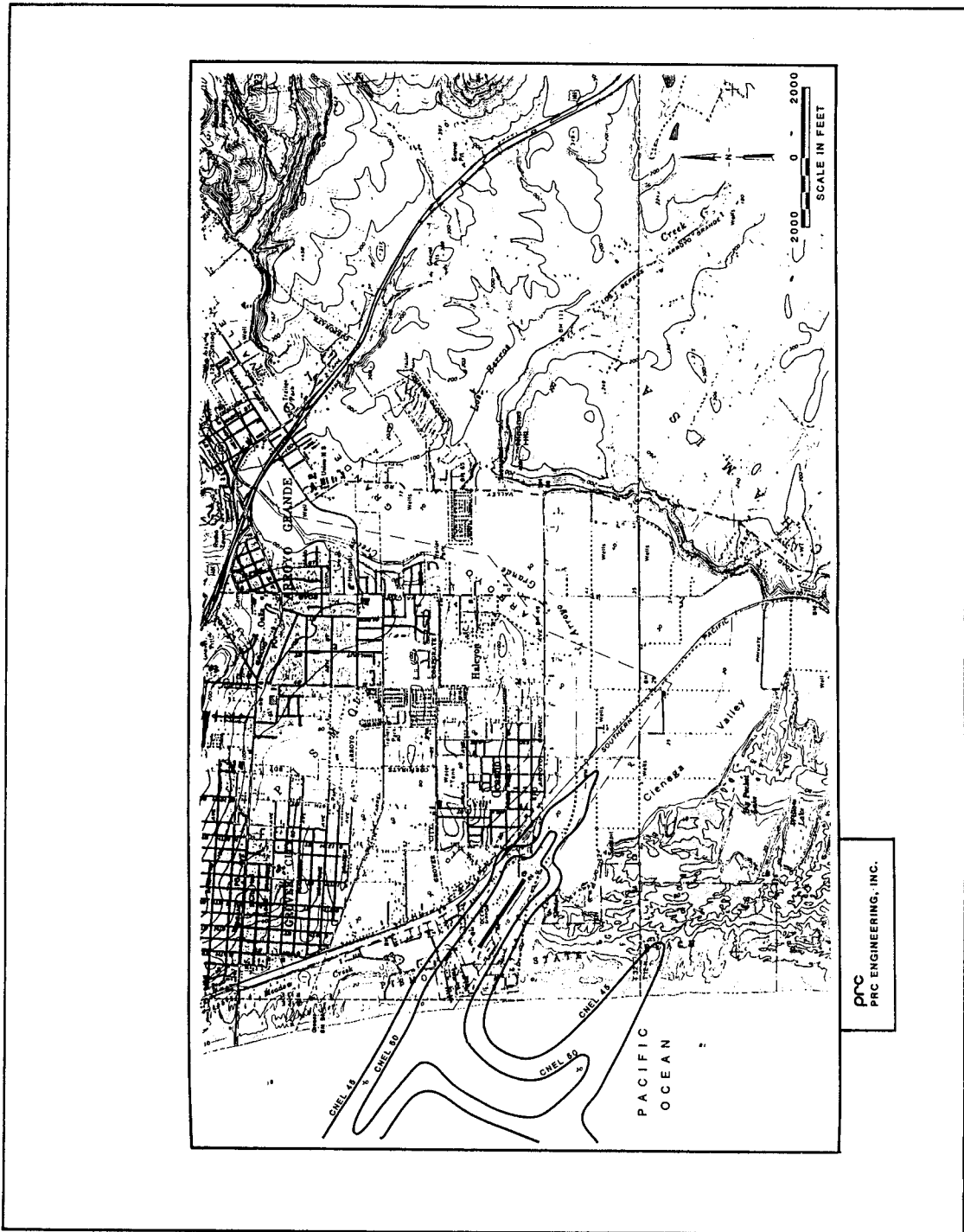

**FIGURE C-2: OCEANO COUNTY AIRPORT
YEAR 2005 NOISE CONTOURS**



**FIGURE C-3: SAN LUIS OBISPO COUNTY AIRPORT
NOISE CONTOURS AT AIRFIELD CAPACITY**

APPENDIX D: NOISE CONTOUR DATA - DISTANCE FROM CENTER OF ROADWAY TO LDN CONTOURS

Using the FHWA Model and the traffic data summarized in Appendix A of the Technical Reference Document, the distances from the center of the roadway to the 60, 65 and 70 dB L_{DN} contours for existing and projected future traffic conditions were calculated. Contour distances are summarized in the following table. The table is subdivided into state highways and rural country roadways. Roadway segments listed in the table refer to the traffic data print-out summarized in Appendix A of the Technical Reference Document. Noise contour calculations generally were performed only for roadways which had an existing or projected future ADT of 5000 or greater, since at lower traffic volumes the 60 dB L_{DN} contour would be confined to an area closer to the roadway than normal residential setbacks. Where medium and heavy truck volumes were greater than about 6% or where speeds were greater than 50 mph, noise contours were calculated for roadways with less than 5000 AADT.

It should be noted that since noise contour calculations did not take into consideration shielding caused by local buildings or topographical features, the distances reported in the following table should be considered worst-case estimates of noise exposure. Noise exposure behind the first row of houses or other types of buildings may be reduced by up to 15 dB. The effects of elevated or depressed roadways or other topographic features, which are common along many roadway segments throughout the county, are described in Table 2-1 in this Policy Document.

APPENDIX D

**NOISE CONTOUR DATA
DISTANCE (FEET) FROM CENTER OF ROADWAY
TO L_{DN} CONTOURS**

Segment Nos.	Description	Existing			Future		
		60 dB	65 dB	70 dB	60 dB	65 dB	70 dB
STATE HIGHWAYS							
Highway 1							
1-2	Santa Barbara County to Valley Road	95	44	21	136	63	29
3-4	Valley Road to Halcyon Road	152	71	33	223	104	48
5-6	Halcyon Road to Grand Ave.	179	83	39	257	119	55
7-8	Grande Ave. to Jct Route 101	123	57	27	168	78	36
9-10	Jct. Route 101 to Highland Drive (Santa Rosa Street)	296	137	64	384	178	83
11-12	Highland Drive to S. Morro Bay Intrchg.	478	222	103	644	299	139
13-14	S. Morro Bay Intrchg. to N. Morro Bay Intrchg.	456	212	98	614	285	132
15-16	N. Morro Bay Intrchg. to Jct Route 41	470	218	101	594	276	128
17-18	Jct. Route 41 to Old Creek Rd. Intrchg.	370	172	80	463	215	100
19-20	Old Creek Rd. Intrchg. to Ardath Dr.	190	88	41	209	97	45
21-22	Aradath Dr. to Pico Creek	171	80	37	207	96	44
23-24	Pico Creek to Hearst Castle State Park	172	80	37	197	91	42
25-26	Hearst Castle State Park to Monterey Co.	79	37	17	103	48	22
Highway 41							
27-28	Jct. Route 1 to Cerro Alto Road	178	83	38	276	128	60
29-30	Cerro Alto Road to Santa Rosa Road	138	64	30	187	87	40
31-32	Santa Rosa Road to Jct. Route 101	159	74	34	298	138	64
33-34	Jct. Route 101 to Olmeda Street	255	119	55	384	178	83
35-36	Olmeda Street to Templeton Road	59	28	13	85	39	18
37-38	Templeton Road to Jct. Route 229	45	21	10	61	28	13
39-40	Jct. Route 229 to West Jct Route 46	27	13	6	42	20	9
41-42	East Jct. Route 46 to Kern County	209	97	45	314	146	68

APPENDIX D

**NOISE CONTOUR DATA
DISTANCE (FEET) FROM CENTER OF ROADWAY
TO L_{DN} CONTOURS**

Segment Nos.	Description	Existing			Future		
		60 dB	65 dB	70 dB	60 dB	65 dB	70 dB
STATE HIGHWAYS							
Highway 46							
43-44	Jct. Route 1 to Vineyard Drive	77	36	16	88	41	19
45-46	Vineyard Drive to Jct. Route 101	102	47	22	121	56	26
47-48	Jct. Route 101 to Paso Robles Airport Road	600	278	129	773	359	167
49-50	Paso Robles Airport Road to Jct. Route 41	494	229	106	704	327	152
51-52	Jct. Route 41 to Kern County	331	153	71	471	219	101
Route 58							
53-54	Jct. Route 101 to “J” Street	161	75	35	227	105	49
55-56	“J” Street to Jct. Route 229	99	46	21	139	65	30
Route 101							
57-58	Santa Barbara County to Oak Park Road Intchg.	855	397	184	1,204	559	259
59-60	Oak Park Road Intchg. to S. Pismo Beach Intchg.	989	459	213	1,851	859	399
61-62	S. Pismo Beach Intchg. to Avila Road	919	426	198	1,519	705	327
63-64	Avila Road to Los Osos Valley Road Intchg.	986	457	212	1,391	645	300
65-66	Los Osos Valley Road Intchg. to Higuera Street	891	414	192	1,268	589	273
67-68	Higuera Street to Jct. Route 1	1,077	500	232	1,588	737	342
69-70	Jct. Route 1 to Grande Ave.	970	450	209	1,698	788	366
71-72	Grande Ave. to S. Paso Robles Intchg.	861	400	185	1,420	659	306
73-74	S. Paso Robles Intchg. to Jct. Route 46 East	674	313	145	1,156	537	249
75-76	Jct. Route 46 East to South San Miguel Intchg.	669	311	144	981	455	211
77-78	South San Miguel Intchg. to Monterey County	629	292	136	981	455	211

APPENDIX D

**NOISE CONTOUR DATA
DISTANCE (FEET) FROM CENTER OF ROADWAY
TO L_{DN} CONTOURS**

Segment Nos.	Description	Existing			Future		
		60 dB	65 dB	70 dB	60 dB	65 dB	70 dB
STATE HIGHWAYS							
Route 106							
79-80	Hwy 101 to Kern County	149	69	32	185	86	40
Route 227							
81-82	Jct. Rte 101 (Arroyo Grande) to Price Canyon Rd.	76	35	16	129	60	28
83-84	Price Canyon Road to Tank Farm Road	174	81	37	292	135	63
85-86	Tank Farm Road to Orcutt Road	208	97	45	311	145	67
87-88	Orcutt Road to South St. (within SLO City Limits)	251	117	54	371	172	80
89-90	South St. to Higuera St. (within SLO City Limits)	127	59	27	176	82	38
COUNTY AREA ROADS							
Estero							
91-92	Los Osos Valley Rd. (SLO plng, bndry to Sombrero)	293	136	63	469	218	101
93-94	Los Osos Valley Rd. (Sombrero to South Bay Blvd)	252	117	54	367	170	79
95-96	Los Osos Valley Rd. (South Bay Blvd. to 9th St.)	158	74	34	231	107	50
97-98	Los Osos Valley Rd. (9th St. to Pecho Road)	106	49	23	167	78	36
99-100	Santa Ysabel Ave. (2nd St. to South Bay Blvd)	95	44	20	112	52	24
101-102	South Bay Blvd. (LOVR to Urban Reserve Line)	223	104	48	317	147	68
103-104	El Morro Ave. (3rd Street to 11th Street)	36	17	8	67	31	14
105-106	7th Street (Ramona Ave. to Santa Ysabel)	52	24	11	74	34	16
107-108	Ramona Ave. (Pine Street to 11th Street)	46	21	10	75	35	16
109-110	Pine Ave. (Ramona Ave. to LOVR)	47	22	10	66	31	14
111-112	9th Street (Ramona Ave. to LOVR)	56	26	12	80	37	17
113-114	Santa Inez Ave. (9th Street to 11th Street)	59	27	13	73	34	16

APPENDIX D

**NOISE CONTOUR DATA
DISTANCE (FEET) FROM CENTER OF ROADWAY
TO L_{DN} CONTOURS**

Segment Nos.	Description	Existing			Future		
		60 dB	65 dB	70 dB	60 dB	65 dB	70 dB
115-116	10 Street (Los Osos Valley Road to Nipomo Ave.)	59	27	13	83	38	18
North Coast							
117-118	Main Street (Hwy 1 to Santa Rosa Creek crossing)	63	29	14	153	71	33
119-120	Burton Dr. (Main Street to Ardath Drive)	57	27	12	96	45	21
121-122	Aradath Drive	42	20	9	90	42	19
123-124	Windsor Blvd. (Main Street thru Tract 159)	43	20	9	69	32	15
125-126	Moonstone Beach Drive	45	21	10	70	32	15
Salinas River/Adelaida							
127-128	Vineyard Drive (Route 46 to Bethel Road)	110	51	24	108	50	23
129-130	Vineyard Drive (Bethel Road to Hwy 101)	110	51	24	224	104	48
131-132	Las Tablas (Route 46 to Bethel Road)	75	35	16	86	40	18
133-134	Las Tablas (Bethel Road to Hwy 101)	75	35	16	228	106	49
135-136	Las Tablas (east of Hwy 101)	61	28	13	95	44	20
137-138	Main Street (Old County Road to Vineyard Drive)	84	39	18	161	75	35
139-140	Main Street (north of Old County Road)	84	39	18	211	98	45
141-142	Nacimiento Lake Dr. (east of Chimney Rock Rd)	108	50	23	187	87	40
San Luis Bay							
143-144	San Luis Bay Drive (west of Hwy 101)	114	53	25	193	90	42
145-146	Avila Road (west of San Luis Bay Sr.)	222	103	48	325	151	70
147-148	Corbett Canyon Rd. (Hwy 227 to Arroyo Grande)	92	43	20	149	69	32
149-150	Noyes Road	54	25	12	107	50	23
151-152	Lopez Drive (Arroyo Grande Fringe)	108	50	23	148	69	32
153-154	San Luis Street. (Avila Beach urban area)	38	18	8	61	28	13
155-156	Pier Ave.	62	29	13	65	30	14

APPENDIX D

**NOISE CONTOUR DATA
DISTANCE (FEET) FROM CENTER OF ROADWAY
TO L_{DN} CONTOURS**

Segment Nos.	Description	Existing			Future		
		60 dB	65 dB	70 dB	60 dB	65 dB	70 dB
157-158	Halcyon Road (north of Hwy 1)	92	43	20	101	47	22
San Luis Obispo							
159-160	Los Osos Valley Rd. (W. SLO City limit to Foothill Note: For area between Hwy 101 and Madonna Road, see segments 221-222, Table 3-4, Technical Reference Document.	329	153	71	410	190	88
161-162	LOVR (Foothill to Estero planning area)	293	136	63	469	218	101
163-164	Tank Farm Road (South Higuera to Broad Street)	200	93	43	278	129	60
165-166	Orcutt Road (SLO urban area)	52	24	11	207	96	45
South County							
167-168	Tefft Street (west of Hwy 101 - Nipomo)	114	53	25	317	147	68
169-170	Orchard Ave. (Nipomo urban area)	77	36	17	173	80	37
171-172	Pomeroy Road (south of Sandydale Road)	105	49	23	133	62	29
173-174	Thompson Ave. (Nipomo urban area)	57	27	12	128	59	28
175-176	North Frontage (Nipomo urban area)	86	40	19	114	53	24
177-178	South Frontage (Nipomo urban area)	62	29	13	99	46	21
179-180	Division Street (Nipomo urban area)	45	21	10	82	38	18

APPENDIX E: DISTANCE (FEET) FROM CENTER OF TRACK TO FUTURE _{LDN} CONTOURS - SOUTHERN PACIFIC RAILROAD¹

LDN Contour Values	Distance (Feet) from Center of Track	
	Beyond 1,000' From Grade Crossing*	Within 1,000' of Grade Crossing*
70 dB	76	113
65 dB	463	244
60 dB	352	525

* Grade Crossings are at the following streets: (all are shown on 400-scale maps in Appendix A)

- River Road (San Miguel)
- 11th Street (San Miguel)
- Wellsona Road (Wellsona)
- Volpi Ysabel Road (Paso Robles urban area)
- Marquita Avenue (Templeton)
- Phillips Road (Templeton)
- Estrada Avenue (Santa Margarita)
- Encina Avenue (Santa Margarita)
- Wilhelmina Avenue (Santa Margarita)
- Beach Street (Oceano)
- Twenty-Second Street (Oceano)

¹Based on a hypothetical operational scenario consisting of 10 freight and 4 passenger trains per day.

Source: Brown-Buntin Associates, Inc.

COUNTY OF SAN LUIS OBISPO GENERAL PLAN

**NOISE ELEMENT, PART II
ACOUSTICAL DESIGN MANUAL**

ADOPTED BY
THE SAN LUIS OBISPO COUNTY BOARD OF SUPERVISORS
MAY 5, 1992 - RESOLUTION 92-227

PREPARED BY
BROWN-BUNTIN ASSOCIATES, INC

COUNTY OF SAN LUIS OBISPO

Board of Supervisors

Harry Ovitt, District 1
Shirley Bianchi, District 2
James Patterson, District 3
K. H. Achadjian, District 4
Jerry Lenthall, District 5

Department of Planning and Building

Victor Holanda, AICP, Director
Pat Beck, Assistant Planning Director
Kami Griffin, Supervising Planner
Jennifer Jimenez, Administrative Assistant

TABLE OF CONTENTS

<u>Sections:</u>	<u>Page:</u>
Chapter 1: INTRODUCTION	1 - 1
1.1 Purpose and Limitations	1 - 1
Chapter 2: TERMINOLOGY	2 - 1
Chapter 3: DETERMINATION OF NOISE EXPOSURE	3 - 1
3.1 Noise Exposure Information	3 - 1
3.2 Noise Source Characteristics	3 - 1
Chapter 4: NOISE MITIGATION	4 - 1
4.1 Site Design	4 - 1
4.2 Standard Noise Mitigation Packages	4 - 1
4.2.1 Mitigation in Outdoor Activity Areas - Minor Use Permits and Dev Plans	4 - 2
4.2.2 Interior Noise Mitigation - Minor Use Permits and Dev Plans	4 - 3

<u>Table:</u>	<u>Page:</u>
1-1 Determining Noise Mitigation for New Development of Noise - Sensitive Uses Plot and Site Plans	1 - 3
4-1 Determination of Noise Barrier Effectiveness	4 - 3

<u>Figure:</u>	<u>Page:</u>
1-1 Flow Chart for determining Noise Exposure and Mitigation for New Development of Noise-Sensitive Uses: Minor Use Permits and Dev Plans	1 - 2
3-1 Chart for Locating Noise Exposure Information	3 - 2
4-1 Examples of Simple and Complex Barrier Situations	4 - 4
A-1	A - 2
A-2	A - 3
A-3	A - 4

<u>Appendix:</u>	<u>Page:</u>
A. Techniques for Noise Control	A - 1
B. Example of Attic Vent Baffle Treatment	B - 1

1: INTRODUCTION

1.1 Purpose and Limitations

This Acoustical Design Manual is adopted as part of the Noise Element of the General Plan. The purpose of this manual is to provide county and city staff, developers, builders and homeowners with a guide for reducing outdoor and indoor noise exposure from traffic, railroads and aircraft to acceptable levels. The manual is not intended to address situations where noise is produced by stationary noise sources (e.g., power plants, mining operations or other commercial, industrial or agricultural operations). In addition, this manual should not be used to address complex acoustical situations where the noise source is at an elevation significantly different from the receiver or the noise source is shielded from the receiver by buildings or topography. Such situations should be studied by an acoustical expert. Figure 1-1 is a flow chart illustrating the process which should be followed in applying the recommendations of this manual.

This manual contains standard noise mitigation packages which may be used to reduce exterior noise exposure by up to 5 dB and interior noise levels by 15, 20, 25, and 30 dB. The standard noise mitigation packages should be used with the noise exposure information contained within the Policy and Technical Reference Documents to achieve compliance with the policies of the Noise Element in relatively simple situations. Standard noise mitigation packages may be prescribed in lieu of the requirement for a detailed acoustical analysis. See Figure 1-1 and Table 1-1 for the situations where the standard mitigation packages may be used.

FIGURE 1-1

FLOW CHART FOR DETERMINING NOISE EXPOSURE AND MITIGATION FOR NEW DEVELOPMENT OF NOISE-SENSITIVE USES: MINOR USE PERMITS AND DEVELOPMENT PLANS

START HERE

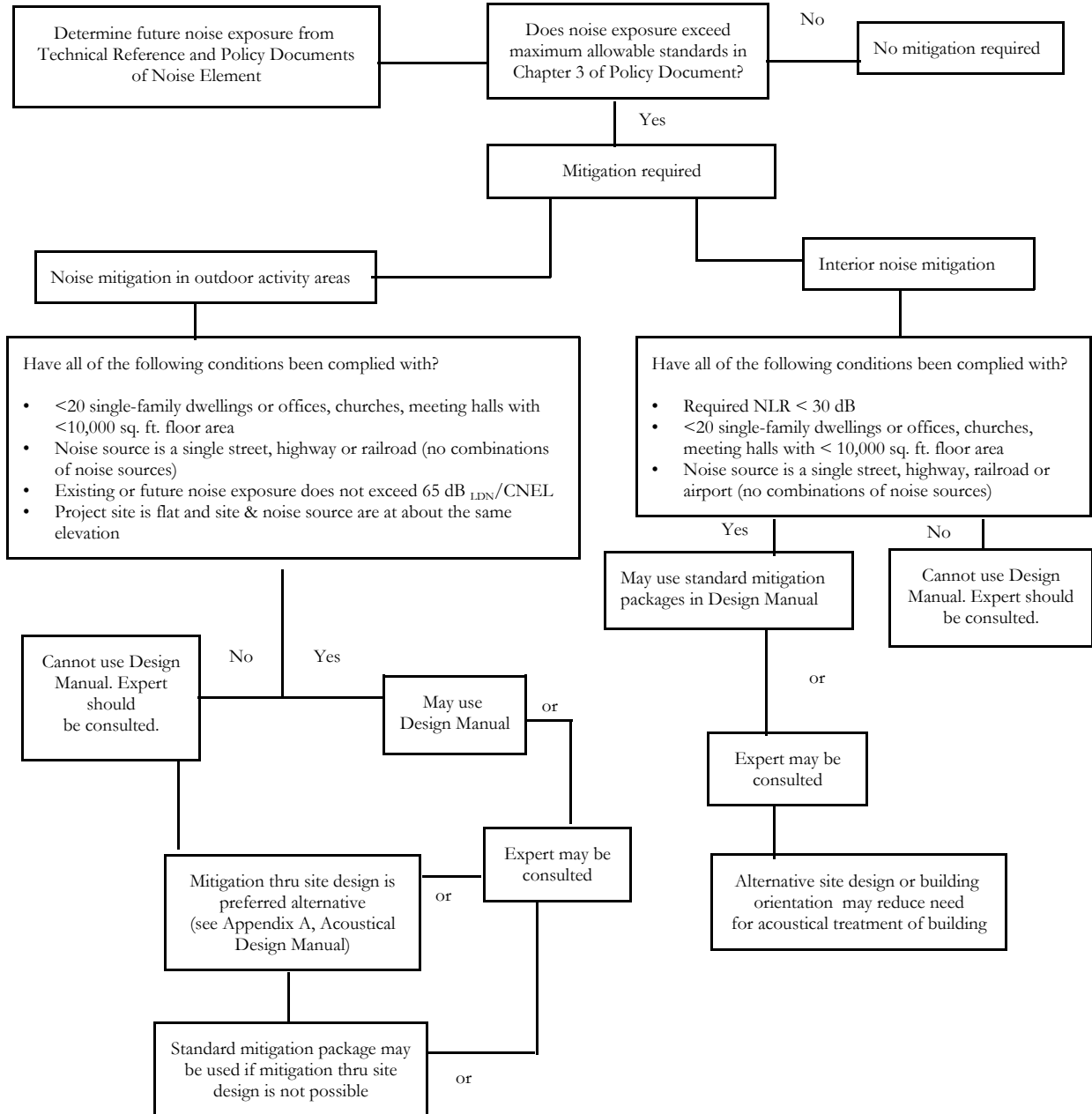

TABLE 1-1

**DETERMINING NOISE MITIGATION FOR NEW DEVELOPMENT OF
NOISE-SENSITIVE USES: PLOT AND SITE PLANS**

A. Is Mitigation Required?

1. Is the proposed use one of the following?
Residential development (except temporary dwellings), school, hospital, nursing and personal care, church, public assembly and entertainment, libraries and museums, hotels and motels, bed and breakfast facilities, outdoor sports and recreation, offices.

If yes, go to #2; if no, NO MITIGATION REQUIRED

2. Is future noise exposure at the noise-sensitive use or outside activity area (from maps or table in Policy Document, Appendices A, B, C, D, or E) above $60\text{dB}_{\text{LDN}}/\text{CNEL}$ for transportation noise sources or above the standards in Table 3-2 of the Policy Document?

If yes, go to #3; if no, NO MITIGATION REQUIRED

3. For traffic noise, is future noise exposure between 60 and 65 Db_{LDN} and roadway is either a) below grade in a cut/embankment or b) elevated more than 15 feet above and within 200 feet of proposed noise-sensitive use, including outdoor activity area?

If no, go to #4; if yes, NO MITIGATION REQUIRED

4. Has an acoustical analysis prepared by an expert been submitted at the option of the applicant which demonstrates that no mitigation is needed?

If no, MITIGATION REQUIRED, go to B; if yes, NO MITIGATION REQUIRED

B. Is Mitigation to be Accomplished by Following the Recommendations of an Acoustical Analysis Prepared by an Expert?

If the answer to any one of the following is yes, then implementation of the recommendations of an acoustical analysis prepared by an expert is required. If not, an acoustical analysis may be submitted at the option of the applicant or go to C.

1. Is the proposed use other than single-family residential, office, church, or meeting hall?
2. Is the noise source a stationary source?
3. Is the proposed use affected by more than one noise source?
4. Is the future noise exposure either a) greater than $75\text{ dB }L_{\text{DN}}/\text{CNEL}$ at the office, church or meeting hall, b) greater than $65\text{ dB }L_{\text{DN}}/\text{CNEL}$ at the single-family residence, or c) greater than $65\text{ dB }L_{\text{DN}}/\text{CNEL}$ in any outdoor activity area?

5. Is the outdoor activity area sloped or not at approximately the same grade as the noise source (with the exception of aircraft noise)?

C. Standardized Mitigation Packages

The following or a suitable alternative approved by the Building Official shall be required when the future noise exposure is as shown.

Interior Mitigation

1. 60 - 65 dB $L_{DN}/CNEL$
 - a. Air conditioning or a mechanical ventilation system
 - b. Windows and sliding glass doors mounted in low air infiltration rate frames (0.5 cfm or less, per ANSI specifications)
 - c. Solid core exterior doors with perimeter weather stripping and threshold seals
2. 65 - 70 dB $L_{DN}/CNEL$
 - a. Same as No. 1 a-c
 - b. Exterior walls consist of stucco or brick veneer. Wood siding with a 1/2" minimum thickness fiberboard ("soundboard") underlayer may also be used.
 - c. Glass in both windows and doors should not exceed 20% of the floor area in a room.
 - d. Roof or attic vents facing the noise source should be baffled (see Appendix C in Acoustical Design Manual for an example of a suitable vent treatment).
 - e. For aircraft noise exposure, same as a-d plus:
 - 1) Fireplaces should be fitted with tight-fitting dampers and glass doors.
 - 2) Solid sheeting with a minimum thickness of 1/2" should underlay roofing materials.
 - 3) Skylights should not be allowed in occupied rooms.
3. 70 - 75 dB $L_{DN}/CNEL$
 - a. Same as No. 2 a-e
 - b. The interior sheetrock of exterior wall assemblies should be attached to studs by resilient channels. Staggered studs or double walls are acceptable alternatives.

- c. Window assemblies should have a laboratory-tested STC rating of 30 or greater. (Windows that provide superior noise reduction capability and that are laboratory-tested are sometimes called “sound-rated” windows. In general, these windows have thicker glass and/or increased air space between panes. In contrast, standard energy-conservation double-pane glazing with a 1/8" or 1/4" air space may be less effective in reducing noise from some noise sources than single-pane glazing.)
- d. For aircraft noise exposure, same as 3 a-c, plus:
 - 1) Fireplaces should not be allowed.
 - 2) Solid sheeting with a minimum thickness of 1/2" should underlay roofing materials.
 - 3) Ceilings should be attached to joists by resilient channels.
 - 4) Skylights should not be allowed in occupied rooms.

CHAPTER 2: TERMINOLOGY

The following section describes the acoustical terminology used in this manual. Unless otherwise stated, all sound levels referred to in this manual are A-weighted decibels (dB). A-weighting de-emphasizes the very low and very high frequencies of sound in a manner similar to the human ear. Most community noise standards utilize A-weighting, as it provides a high degree of correlation with human annoyance and health effects.

COMMUNITY NOISE EQUIVALENT LEVEL, CNEL: The equivalent energy (or energy average) sound level during a 24-hour day, obtained after addition of approximately five decibels to sound levels in the evening from 7:00 p.m. to 10:00 p.m. and ten decibels to sound levels in the night before 7:00 a.m. and after 10:00 p.m. The CNEL is generally computed for annual average conditions.

DECIBEL, dB: A unit for describing the amplitude of sound, equal to 20 times the logarithm to the base 10 of the ratio of the pressure of the sound measured to the reference pressure, which is 20 micropascals (20 micronewtons per square meter).

DAY/NIGHT AVERAGE SOUND LEVEL, L_{DN} : The equivalent energy (or energy average) sound level during a 24-hour day, obtained after addition of ten decibels to sound levels in the night after 10:00 p.m. and before 7:00 a.m. The L_{DN} contours are frequently utilized to describe community exposure to noise.

NEW DEVELOPMENT: Projects requiring land use or building permits, but excluding remodeling or additions to existing structures. Includes modifications to existing stationary noise sources that increase noise levels.

NOISE EXPOSURE CONTOURS: Lines drawn about a noise source indicating constant levels of noise exposure. CNEL and L_{DN} contours are frequently utilized to describe community exposure to noise.

NOISE LEVEL REDUCTION, NLR: The arithmetic difference between the level of sound outside and inside a structure measured in decibels. For example, if the sound level outside a house is 70 dB and the level inside a room of the house is 45 dB, the NLR is 25 dB ($70-45=25$).

RESILIENT CHANNEL (CLIP): A metal device that allows indirect attachment of an interior wall to a stud or a ceiling to a joist. Resilient channels improve the noise reduction capability of the wall or roof/ceiling assembly.

SOUND TRANSMISSION CLASS, STC: A single-number rating system for determining the amount of noise reduction provided by a window, door or other building component. The higher the STC rating, the more efficient the component will be in reducing noise. Windows and doors having a minimum STC rating are sometimes required to ensure that a building facade will achieve a minimum Noise Level Reduction (NLR). STC ratings may not be subtracted from exterior noise exposure values to determine interior noise exposure values.

CHAPTER 3: DETERMINATION OF NOISE EXPOSURE

3.1 Noise Exposure Information:

The noise exposure information contained within the Policy and Technical Reference Documents of the Noise Element should be used to determine project site noise exposure and whether or not the recommendations of this manual are applicable to a particular project. Noise exposure information is available from these documents for the major transportation noise sources identified for study at the time the Noise Element update was prepared. Noise exposure information is also available within these documents for a representative sampling of stationary noise sources. Since noise from most stationary sources is difficult to quantify, and there are probably significant stationary noise sources which were not included in the Noise Element, noise from stationary noise sources should be evaluated by an acoustical expert.

The chart shown in Figure 3-1 illustrates where noise exposure information for a particular location may be found. Noise exposure information may be used to determine if new development is consistent with the policies of the Noise Element. If the noise exposure of new development will exceed the thresholds for mitigation or the maximum allowable standards in Chapter 3 of the Policy Document, noise mitigation will be required.

3.2 Noise Source Characteristics:

In determining the magnitude of noise impact and strategies for reducing noise impact, it is important to be aware of the characteristics of noise produced by different sources. The most important characteristics of the three transportation noise sources this manual has been designed to address are described below:

- **Traffic:** For purposes of noise assessment, traffic is divided into automobiles, medium trucks (those having only two axles) and heavy trucks (those with three or more axles). The effective heights of noise propagation from automobiles, medium trucks and heavy trucks are, respectively, 0, 2 and 8 feet above the crown of the road.
- **Railroads:** The effective source heights of railroad noise is mostly determined by noise emitted by the locomotive, which is generally assumed to be 10 feet above the rails. However, the effective height of noise for a locomotive blowing its horn is increased to 15 feet above the rails since the horn is situated on top of the locomotive. In many situations the effective source height of trains is even greater than the heights noted above since the rails rest on a gravel bed that is often three or more feet higher than surrounding terrain.
- **Aircraft:** Aircraft in flight near an airport are usually a few hundred to several thousand feet above the ground. When aircraft noise exposure is an issue, generally the aircraft are overhead or are at least 30 degrees above the horizon. In such situations, the use of barriers to reduce exterior noise levels is not feasible.

**FIGURE 3-1
CHART FOR LOCATING NOISE EXPOSURE INFORMATION**

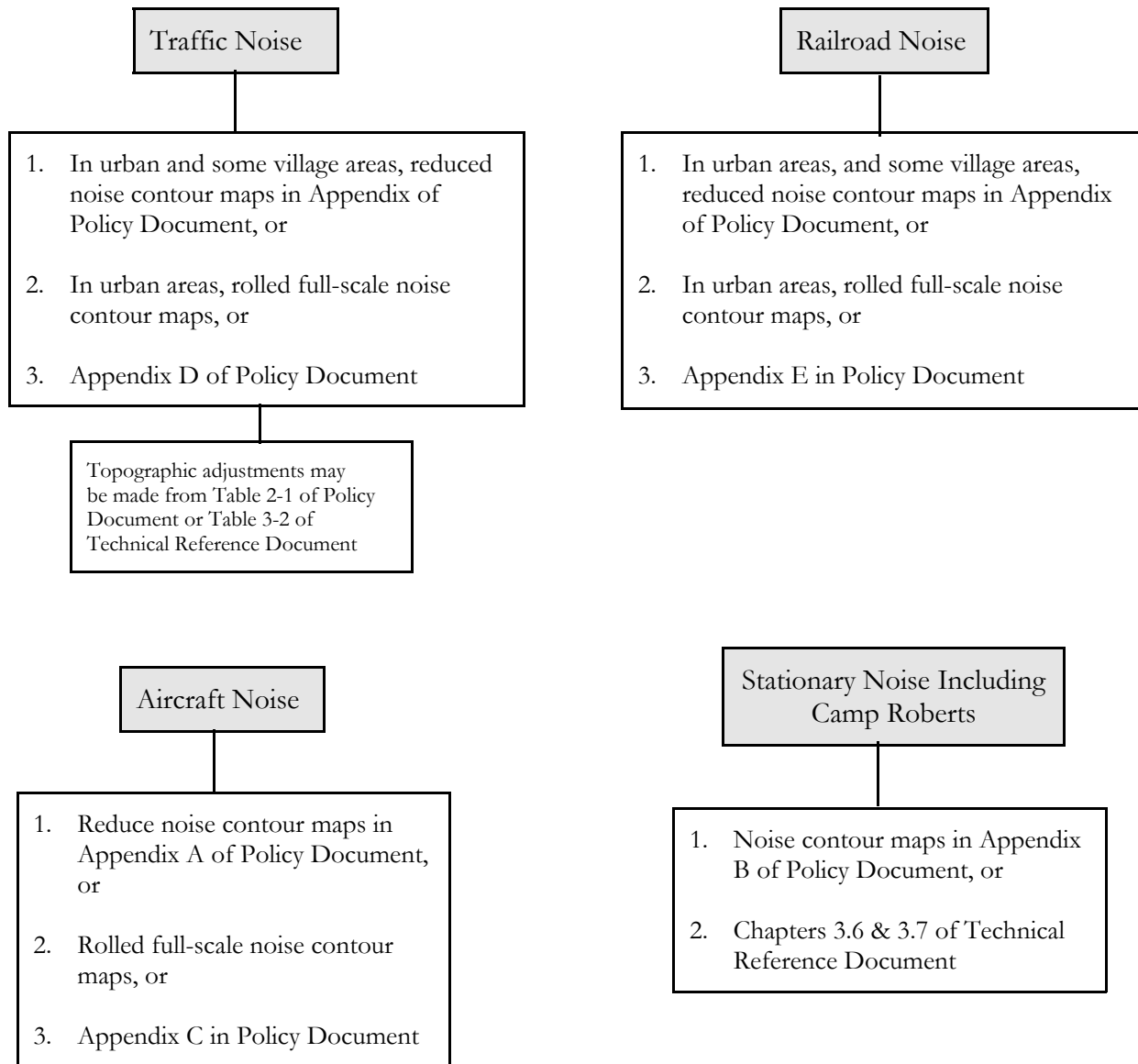

CHAPTER 4: NOISE MITIGATION

4.1 Site Design:

The preferable form of noise mitigation is the effective design of a project so that noise-sensitive uses are not located in areas exposed to excessive noise levels. This may be accomplished by using building setbacks, natural topography, building orientation, and intervening buildings which do not contain noise-sensitive land uses to reduce noise exposure at the receiving location. Such measures may minimize or eliminate the need to construct noise barriers or to acoustically treat buildings.

Appendix A of this manual provides an overview of the various techniques available for noise mitigation. The information contained within Appendix A should be used in a general way to evaluate the acoustical effectiveness of project site designs and noise mitigation measures proposed to achieve compliance with the policies of the Noise Element. It should be understood that there is no simple way to determine with certainty if a site design will succeed in adequately reducing noise exposure, unless an acoustical analysis of the project is performed by an expert. If there is a question about the effectiveness of proposed noise mitigation measures, the reviewing agency may require an acoustical analysis or apply the standard noise mitigation packages described below.

4.2 Standard Noise Mitigation Packages:

For Plot and Site Plans, see the Noise Mitigation packages in Table 1-1.

In situations where buildings containing noise-sensitive land uses or outdoor activity areas are proposed for locations where noise levels exceed the standards of the Noise Element, noise mitigation will be required as a part of the project approval or building permit process. Generally, an acoustical analysis prepared by an expert will be required to qualify site-specific noise exposure and to propose effective noise mitigation measures. At the option of the reviewing agency, and subject to the requirements of the Noise Element, the requirement for an acoustical analysis may be waived and standard noise mitigation packages may be utilized to achieve compliance with the policies of the Noise Element.

Standard noise mitigation packages are sets of noise mitigation measures which may be used to reduce exterior noise exposure by prescribed amounts. The standard noise mitigation packages contained within this manual are intended for the reduction of exterior noise exposure in outdoor activity areas or at building facade locations by up to 5 dB. Reductions greater than this are significantly more difficult to achieve, and should be based upon the recommendations of an expert after a detailed study has been performed.

For interior noise exposure, standard noise mitigation packages to achieve outdoor to indoor noise level reductions (NLR) of 15, 20, 25 and 30 dB have been developed. Since these are generalized packages intended to address a variety of specific conditions, a conservative approach has been taken. This means that some of the components specified in the packages could possibly be modified or eliminated to achieve the prescribed NLR values under certain conditions. For this reason, the recommendations from an acoustical expert who has conducted a detailed study of a particular situation may differ somewhat from the standardized packages and yet achieve the desired results.

4.2.1 Mitigation in Outdoor Activity Area - Minor Use Permits and Development Plans:

All of the following conditions must be met before the following standard noise mitigation packages may be used:

- The project is for less than 20 single-family dwellings or for the office buildings, churches, or meeting halls having a total gross floor area of less than 10,000 square feet.
- The noise source consists of a single roadway or railway. Stationary noise sources, or complex noise sources consisting of multiple roadways or roadway/railway combinations must be addressed by an expert.
- The existing or future noise level within the outdoor activity areas does not exceed 65 dB_{LDN}.
- The topography in the project area is flat and both the noise source and proposed project are at approximately the same grade.

If these project conditions are not met, an acoustical analysis performed by an expert must be obtained.

The following standard noise mitigation packages may be implemented to reduce exterior noise levels by approximately 5 dB.

- **Traffic Noise Sources:** Construct a barrier of sufficient height to interrupt line-of-sight between the source and receiver. For roadways where trucks are less than 5% of the Average Daily Traffic (ADT), a source height of 2 feet above the crown of the roadway should be used. For roadways where trucks are 5% or more of the ADT, a source height of 8 feet above the crown of the roadway should be used. In both cases, a receiver height of 5 feet above the grade of the location of the outdoor activity area of concern or building pad elevation should be used.
- **Railroad Noise Sources:** Construct a barrier of sufficient height to interrupt line-of-sight between the source and receiver. Within 1000 feet of a railroad grade crossing, a noise source height of 15 feet above the rails should be assumed. At other locations, a noise source height of 10 feet above the rails should be assumed. When determining the total height of a railroad noise source, the height of the roadbed must be added to the source heights described above. A receiver height of 5 feet above the outdoor activity area of concern or building pad elevation should be used.
- **Aircraft Noise:** Mitigation of exterior noise exposure due to aircraft overflights is generally not possible. Sideline aircraft noise exposure may be reduced by barriers in some cases, but such exposure should be evaluated on a case by case basis by an acoustical expert.
- **Stationary Noise Sources:** Standard noise mitigation packages should not be applied to stationary noise sources due to the unpredictability of source height, noise spectra and the noise levels associated with such sources.

The determination of whether a proposed barrier design will interrupt line-of-sight between the noise source and receiver should be based on the procedure described in Table 4-1. Such methods require the preparation of a scaled cross-section showing the relative heights of the source, proposed barrier and receiver, and the distances between the source and barrier and barrier and receiver. Figure 4-1 provides examples of noise barrier cross-sections for simple and more complex site conditions.

For a noise barrier to be effective, it must consist of massive, tight-fitting materials, such as a grouted concrete block or stucco wall. No openings or cracks may be present in the wall or at the ground/wall interface. Other

noise barrier materials may be acceptable, but should be approved by a qualified acoustical expert. The use of wood for noise barriers is generally not recommended due to problems with warpage, shrinkage and deterioration over time.

Barriers are most effective when placed close to either the source or receiver. A barrier that breaks line-of-sight will reduce noise levels by about 5 dB. Barrier noise reductions ranging from 5 to 15 dB are more difficult to achieve, and the design of such barriers should be based on the recommendations of an expert who has prepared a site-specific study. Noise reductions greater than 15 dB from barriers are generally not feasible.

TABLE 4-1 DETERMINATION OF NOISE BARRIER EFFECTIVENESS	
Step #1:	Select an appropriate scale on graph paper to accommodate the distance from the noise source to receiver and the heights of the noise source and receiver (e.g., 1"=20', 1"=50' etc).
Step #2:	Mark a point representing the effective height of the noise source above the crown of the road or top of the railroad track.
Step #3:	Scale off the distance from the noise source to the receiver and mark a point that is 5 feet above the building pad or outdoor activity area of concern.
Step #4:	Using a ruler, draw a straight line between the noise source and receiver. This line represents line-of-sight between the noise source and receiver (See Figure 4-1).
Step #5:	Determine the location of the proposed noise barrier between the noise source and receiver, and draw a vertical line that extends from the ground to a height that intercepts line-of-sight. The height of this line represents the <u>minimum</u> height of a noise barrier necessary to reduce exterior noise by approximately 5 decibels. Higher barriers will further reduce noise levels.

4.2.2 Interior Noise Mitigation - Minor Use Permits and Development Plans:

The most direct way to determine the interior noise level within a building is through noise level measurements. However, this is not possible if the structure has not yet been constructed. Also, it is generally not practical to perform interior noise level measurements within occupied buildings due to interference caused by activities within the structure and the length of time it takes to obtain representative results.

FIGURE 4-1

EXAMPLES OF SIMPLE AND COMPLEX BARRIERS SITUATIONS

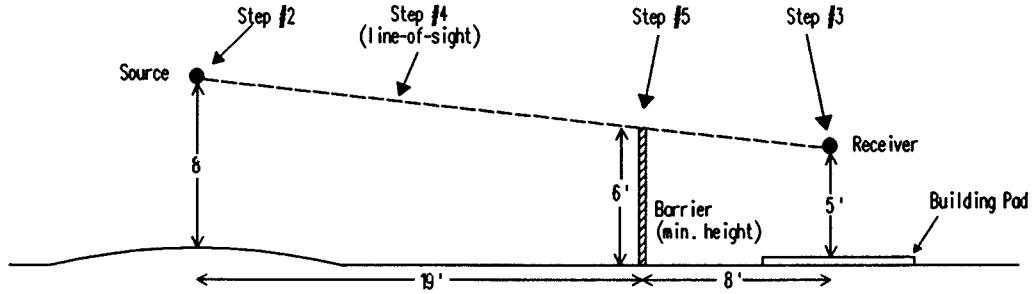

Example of Simple Barrier Situation
(may use standard noise mitigation packages)

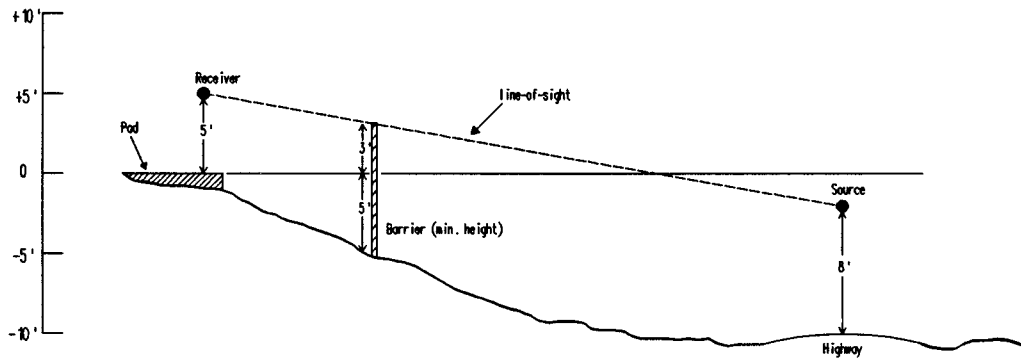

Example of Complex Barrier Situation
(consult an acoustical expert)

Interior noise levels can be estimated if the exterior noise level is known and the outdoor to indoor NLR provided by the building is known. NLR is defined as the arithmetic difference between the level of sound outside and inside a structure, measured in decibels. For example, if the noise level outside a residence is 70 dB and the level inside a room of the residence is 45 dB, the NLR of the structure is 25dB (70-45=25).

To satisfy the interior noise level standards of the Noise Element (see Table 2 in the Policy Document), the NLR provided by a building should equal or exceed the arithmetic difference between the exterior noise level at the building location and the required interior noise level. Referring to the example in the previous paragraph, if the exterior noise level is 70 dB_{LDN} and the required interior noise level is 45 dB_{LDN}, the minimum NLR of the structure must be 25 dB.

The following standard noise mitigation packages should be implemented to achieve NLR values of 15, 20, 25, and 30 dB. If an NLR greater than 30 dB is needed or if there is a question about the effectiveness of the standard noise mitigation packages in a particular situation, the reviewing agency may require that an acoustical analysis be conducted by an expert.

All of the following conditions must be met in order for the following standard noise mitigation packages to be used:

- Required Noise Level Reduction (NLR) is equal to or less than 30 dB.
- The project is for less than 20 single-family dwellings or for offices, churches or meeting halls with less than 10,000 square feet floor area.
- Noise source in question consists of a single transportation noise source (roadway, railway or airport) for which up-to-date noise exposure is available. An acoustical analysis will be required when the noise source is a stationary noise source or consists of multiple transportation noise sources.

For all of the following noise mitigation packages, careful workmanship, including caulking of joints and base plates and installation of weather stripping, is essential to ensure the proper performance of building assemblies. Acoustical “leaks” in walls and roof/ceilings should be avoided by properly sealing penetrations and by eliminating flanking paths.

In addition to the following noise mitigation packages, the use of non-structural mitigation measures is encouraged, such as increasing setbacks from the noise source, shielding noise-sensitive uses with non-noise-sensitive uses and orienting the quiet areas of buildings away from the noise source.

- NLR of 15 dB

Normal construction practices per the latest edition of the Uniform Building code are sufficient to provide a NLR of 15 dB, even if windows or doors are partially open for ventilation.

- NLR of 20 dB

Normal construction practices per the latest edition of the Uniform Building Code are sufficient provided:

- 1) Air conditioning or a mechanical ventilation system is installed so that windows and doors may remain closed.
- 2) Windows and sliding glass doors are mounted in low air infiltration rate frames (0.5 cfm or less, per ANSI specifications).

- 3) Exterior doors are solid core with perimeter weather-stripping and threshold seals.
- NLR of 25 dB

Normal construction practices per the latest edition of the Uniform Building Code are sufficient provided:

- 1) Air conditioning or a mechanical ventilation system is installed so that windows and doors may remain closed.
- 2) Windows and sliding glass doors are mounted in low air infiltration rate frames (0.5 cfm or less, per ANSI specifications).
- 3) Exterior doors are solid core with perimeter weather stripping and threshold seals.
- 4) Exterior walls consist of stucco or brick veneer. Wood siding with a 1/2" minimum thickness fiberboard ("soundboard") underlayer may also be used..
- 5) Glass in both windows and doors should not exceed 20% of the floor area in a room.
- 6) Roof or attic vents facing the noise source should be baffled (see Appendix C for an example of a suitable vent treatment).

For aircraft noise exposure, all of the above plus:

- 1) Fireplaces should be fitted with tight-fitting dampers and glass doors.
- 2) Solid sheeting with a minimum thickness of 1/2" should underlay roofing materials.
- 3) Skylights should not be allowed in occupied rooms.
- NLR of 30 dB

Normal construction practices per the latest edition of the Uniform Building Code are sufficient provided:

- 1) Air conditioning or a mechanical ventilation system is installed so that windows and doors may remain closed.
- 2) Windows and sliding glass doors are mounted in low air infiltration rate frames (0.5 cfm or less, per ANSI specifications).
- 3) Exterior doors are solid core with perimeter weather stripping and threshold seals.
- 4) Exterior walls consist of stucco or brick veneer.
- 5) Glass in both windows and doors should not exceed 20% of the floor area in a room.
- 6) Roof or attic vents facing the noise source should be baffled (see Appendix C for an example of a suitable vent treatment).
- 7) The interior sheetrock of exterior wall assemblies should be attached to studs by resilient channels. Staggered studs or double walls are acceptable alternatives.

- 8) Window assemblies should have a laboratory-tested STC rating of 30 or greater. (Windows that provide superior noise reduction capability and that are laboratory-tested are sometimes called “sound-rated” windows. In general, these windows have thicker glass and/or increased air space between panes. In contrast, standard energy-conservation double-pane glazing with an 1/8" or 1/4" air space may be less effective in reducing noise from some noise sources than single-pane glazing).

For aircraft noise exposure, all of the above plus:

- 1) Fireplaces should not be allowed.
- 2) Solid sheeting with a minimum thickness of 1/2" should underlay roofing materials.
- 3) Ceilings should be attached to joists by resilient channels.
- 4) Skylights should not be allowed in occupied rooms.

APPENDIX A: TECHNIQUES FOR NOISE CONTROL

Any noise problem may be considered as being composed of three basic elements: the noise source, a transmission path and a receiver. The emphasis of noise control in land use planning is usually placed upon acoustical treatment of the transmission path and the receiving structures.

The appropriate acoustical design for a given project should consider the nature of the noise source and the sensitivity of the receiver. The problem should be defined in terms of the noise level criteria L_{DN} , L_{eq} , etc.) contained within the adopted policies of the Noise Element, the location of the sensitive receiver (inside or outside), and when the problem occurs (daytime or nighttime). Noise control techniques should then be selected to provide an acceptable noise environment for the receiving property while remaining consistent with local aesthetic standards and practical structural and economic limits. Basic noise control techniques include the following:

Use of Setbacks:

Noise exposure may be reduced by increasing the distance between the noise source and receiving use. Setback areas can take the form of open space, frontage roads, recreational areas, storage yards, and other non-noise-sensitive uses. The amount of noise attenuation provided by this technique is limited by the characteristics of the site and the noise source. Each doubling of distance from the noise source will reduce noise exposure by about 4 to 6 dB.

Use of Barriers:

Shielding by barriers can be obtained by placing walls, earthen berms or other structures between the noise source and the receiver. The use of earthen berms may be acceptable, but an acoustical expert should be consulted. The effectiveness of a barrier depends upon blocking line-of-sight between the source and receiver, and is improved with increases in the distance the sound must travel to pass over the barrier as compared to a straight line from source to receiver. The use of barriers to reduce noise is discussed in Chapter 4.2.1 where standard noise mitigation packages designed to reduce noise by 5 decibels are recommended for certain prescribed situations. For situations other than those described in this Design Manual, the recommendations of an acoustical expert should be obtained.

Building Location and Orientation:

Buildings containing noise-sensitive uses may be located on a site so that they are outside the area requiring noise mitigation. Buildings can be placed on a site to shield other structures or areas and to prevent an increase in noise level caused by reflections. The use of one building to shield another can significantly reduce overall project noise control costs, particularly if the shielding structure is insensitive to noise. As an example, carports or garages can be used to form or complement a barrier shielding adjacent dwellings or an outdoor activity area. Similarly, one residential unit can be placed to shield another so that noise reduction measures are needed for only the building closest to the noise source. Placement of outdoor activity areas within the shielded portion of a building complex, such as a central courtyard, can be an effective method of providing a quiet retreat in an otherwise noisy environment. Patios or balconies should be placed on the side of a building opposite the noise source, and “wing walls” can be added to buildings or patios to help shield sensitive uses. Shielding by buildings can reduce noise impacts by up to 15 decibels. The exact amount of reduction depends on the efficiency of the design.

Where project design does not allow using buildings or other land uses to shield sensitive uses, noise control costs can be reduced by orienting buildings with the narrow end facing the noise source, thereby reducing total area of the building requiring acoustical treatment. Some examples of building orientation to reduce noise impacts are shown in Figure A-1.

FIGURE A-1

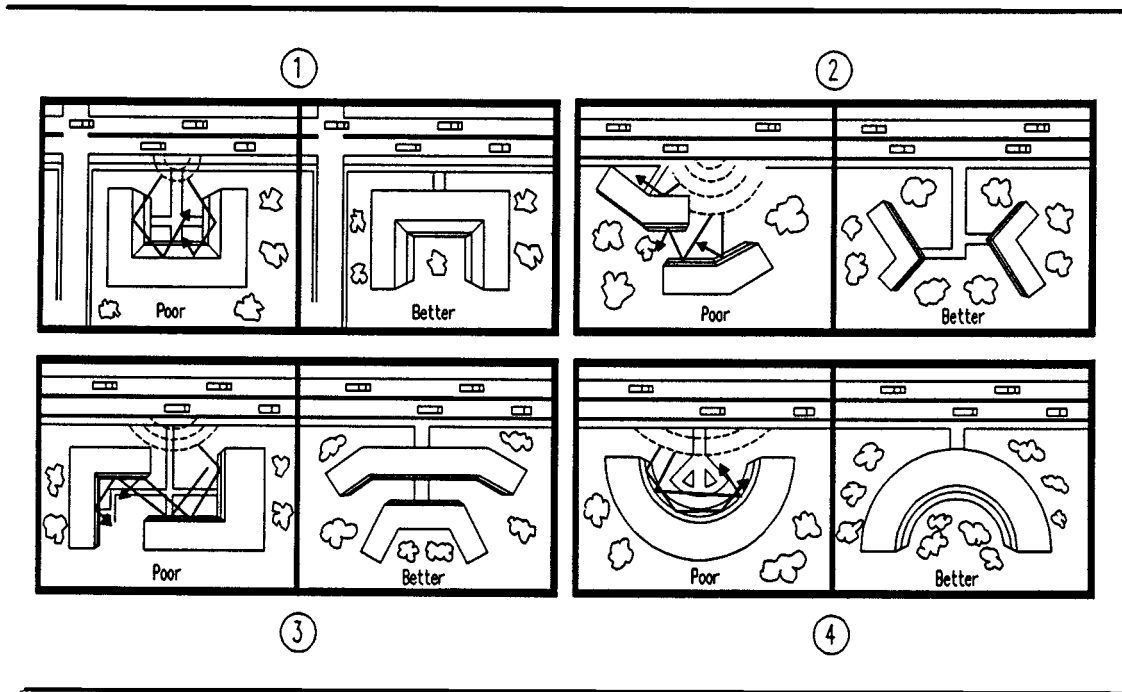

Another option in site design is the placement of relatively insensitive land uses, such as commercial, storage or parking areas, between the noise source and a more sensitive portion of the project. Examples include development of a commercial strip along a busy arterial to block noise affecting a residential area, or providing recreational vehicle storage along the noise-impacted edge of a mobile home park. If existing topography or development adjacent to the project site provides some shielding, as in the case of an existing berm, knoll or building, sensitive structures or activity areas may be placed behind those features to reduce noise control costs (Figure A-2).

FIGURE A-2

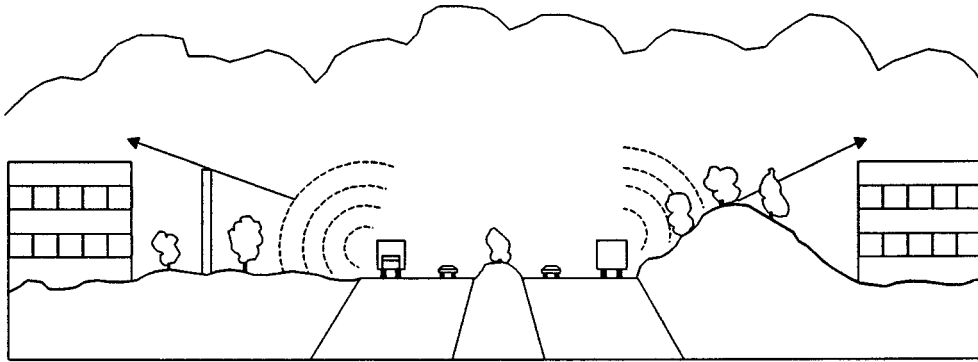

Site design should also guard against the creation of reflecting surfaces which may increase on-site noise levels. For example, two buildings placed at an angle facing a noise source may cause noise levels within that angle to increase by up to 3 dB (see example No. 3, Figure A-1). The open end of a “U” shaped building should point away from noise sources for the same reason (see example No. 4, Figure A-1). Landscaping walls or noise barriers located within a development may inadvertently reflect noise back to a noise-sensitive area unless carefully located.

In some cases, external building facades can influence reflected noise levels affecting adjacent buildings. This is primarily a problem where high-rise buildings are proposed, and the effect is most evident in urban areas, where “urban canyon” may be created. Bell-shaped or irregular building facades, setbacks and attention to building orientation can reduce this effect. Avoidance of these problems, as well as attaining an effective, aesthetic site design requires close coordination between local agencies, the project engineer and architect, and the acoustical consultant.

Acoustical Design of Buildings:

When structures have been located to provide maximum noise reduction by barriers or site design, noise reduction measures may still be required to achieve an acceptable interior noise environment. The cost of such measures may be reduced by the thoughtful placement of rooms. For example, bedrooms, living rooms, family rooms, and other noise-sensitive portions of a dwelling can be located on the side of the unit farthest from the noise source, as shown by Figure A-3.

FIGURE A-3

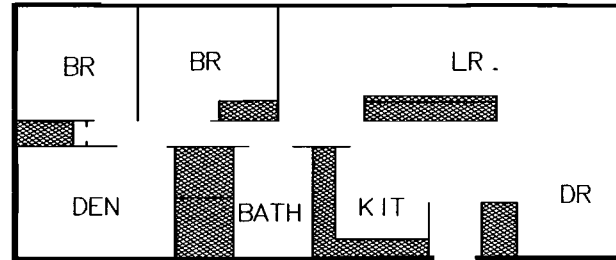

Bathrooms, closets, stairwells and food preparation areas are relatively insensitive to exterior noise sources, and can be placed on the noisy side of a unit. When such techniques are employed, noise reduction requirements for the building facade can be significantly reduced, although the architect must take care to isolate the noise impacted areas by the use of partitions or doors.

When structures containing noise-sensitive uses are to be located in a noisy environment, interior noise exposure may be reduced through the acoustical design of building facades. Standard noise mitigation packages are recommended in this Design Manual for noise level reduction (NLR) values of 15, 20, 25, and 30 decibels. If an NLR greater than 30 decibels is required or if there is a question about the effectiveness of the standard noise mitigation packages in a certain situation, the reviewing agency may require an acoustical analysis.

Use of Vegetation:

It is sometimes assumed that trees and other vegetation can provide significant noise attenuation. However, approximately 100 feet of dense foliage (so that no visual path extends through the foliage) is required to achieve a 5 dB attenuation of traffic noise. The use of vegetation as a noise barrier should not be considered a practical method of noise control unless large tracts of dense foliage are part of the existing landscape.

Vegetation can be used to acoustically “soften” intervening ground between a noise source and receiver by increasing ground absorption of sound. Vegetative barriers have been shown to reduce tire noise and other high frequency components of traffic noise. Planting of trees and shrubs is also of aesthetic and psychological value, and may reduce adverse public reaction to a noise source by removing the source from view, even though noise levels may be largely unaffected.

Sound Absorbing Materials:

Absorptive materials such as fiberglass, foam, cloth, and acoustical tiles are used to reduce reflections or reverberation in closed spaces. Their outdoor use is usually directed toward reducing reflections between parallel noise barriers or other reflective surfaces. Maintenance of absorptive material used outdoors is difficult because such materials are easily damaged by sunlight and moisture. Their application as an outdoor noise control tool is limited to cases where the control of reflected noise is critical.

APPENDIX B: EXAMPLE OF ATTIC VENT BAFFLE TREATMENT

