

RETURN TO: MWH, 1340 TREAT BLVD., #300, WALNUT CREEK CA 94597

ATTN: PAM CARTER  
FUGRO WEST, INC.



**GEOTECHNICAL REPORT**  
Los Osos Wastewater Project  
Los Osos Community Services District  
San Luis Obispo County, California

Prepared for:  
**MONTGOMERY WATSON HARZA**

Prepared by:  
**FUGRO WEST, INC.**

March 9, 2004

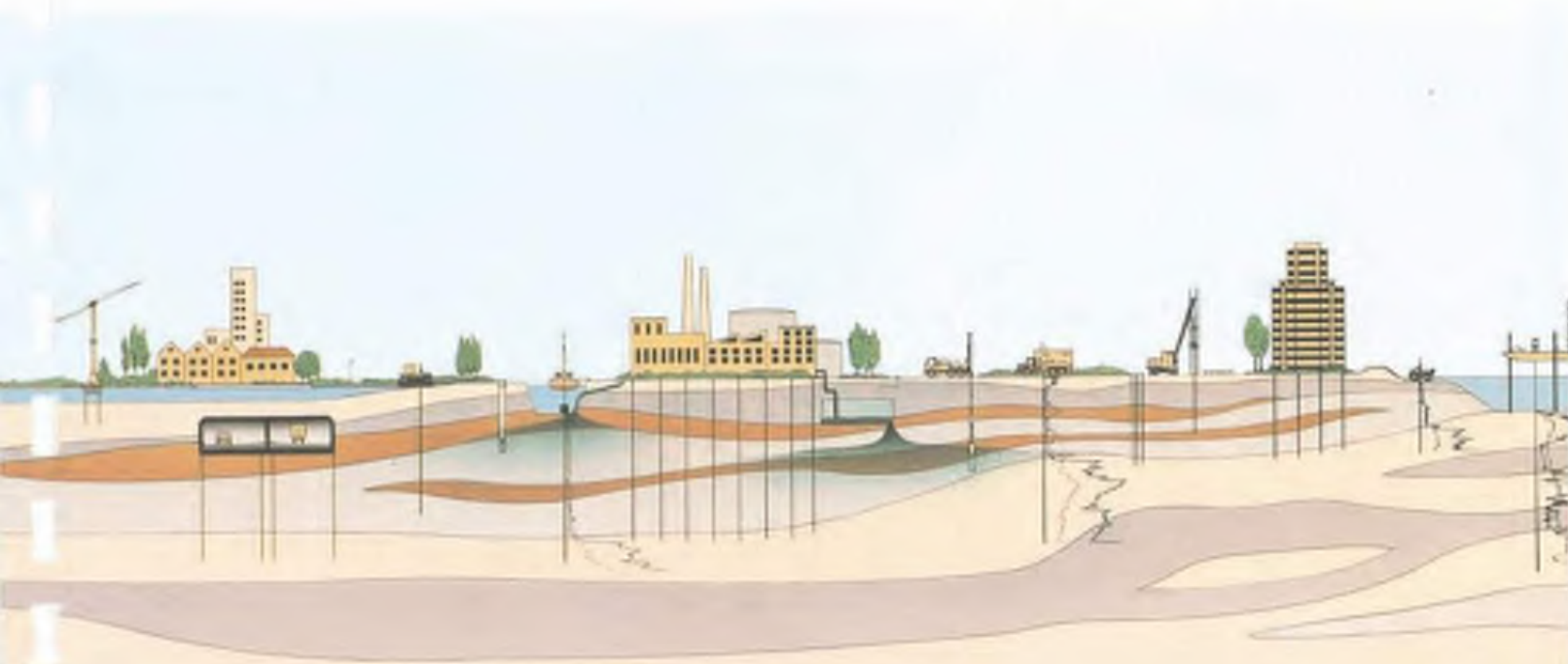



660 Clarion Court, Suite A  
San Luis Obispo, CA 93401  
Tel: (805) 542-0797  
Fax: (805) 542-9311

March 9, 2004  
Project No. 3055.001

Montgomery Watson Harza  
1340 Treat Boulevard, Suite 300  
Walnut Creek, CA 94596

Attention: Mr. Steve Hyland

Subject: Geotechnical Report, Los Osos Wastewater Project, Los Osos Community Services District, San Luis Obispo County, California

Dear Mr. Hyland:

Fugro is pleased to submit this Geotechnical Report for the Los Osos Wastewater project for the Los Osos Community Services District in San Luis Obispo County, California. This report was prepared according to our Consulting Services Subcontract with Montgomery Watson Harza, dated October 31, 2002, and contract amendments No.1 and No. 2 to September 12 and December 5, 2003.

This report summarizes field and laboratory testing data from previous studies compiled during our evaluation, and provides geotechnical recommendations for the design of the proposed wastewater treatment plant, reinforced earth retaining walls, pipeline collection system, pump stations, and the effluent disposal system. Field and laboratory data collected to supplement the previous information, and results from prototype percolation line and drywell testing, are included in this report.

Please contact the undersigned if there are any questions concerning the report.

Sincerely,

FUGRO WEST, INC.

  
Jonathan D. Blanchard, GE 2312, Exp. 12-31-05  
Principal Geotechnical Engineer

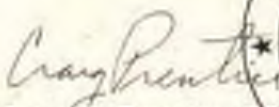

  
Craig D. Prentice, CE 1602  
Associate Engineering Geologist



Copies: 30 - addressee



## TABLE OF CONTENTS

1.	PROJECT DESCRIPTION.....	1-1
1.1	PIPELINE NETWORK .....	1-1
1.2	PUMP STATIONS .....	1-1
1.3	TRI W WASTEWATER TREATMENT PLANT .....	1-2
1.4	EFFLUENT DISPOSAL SITES.....	1-3
2.	SITE DESCRIPTION .....	2-1
2.1	PIPELINE NETWORK .....	2-1
2.2	PUMP STATIONS .....	2-2
2.3	TRI W WASTEWATER TREATMENT PLANT .....	2-2
2.4	EFFLUENT DISPOSAL SITES.....	2-2
3.	WORK PERFORMED.....	3-1
3.1	PURPOSE .....	3-1
3.2	SCOPE .....	3-1
3.3	PREVIOUS STUDIES.....	3-3
3.4	FIELD EXPLORATION .....	3-4
3.4.1	Drilling.....	3-4
3.4.2	Cone Penetration Testing .....	3-5
3.4.3	Hand Auger Borings .....	3-5
3.4.4	Backhoe Trenches.....	3-6
3.5	LABORATORY TESTING.....	3-6
3.6	PROTOTYPE TESTING FOR EFFLUENT DISPOSAL SYSTEM .....	3-7
3.6.1	Percolation Testing .....	3-7
3.6.2	Double Ring Infiltrometer Testing .....	3-9
3.6.3	Prototype Percolation Line.....	3-11
3.6.3.1	Line Installation .....	3-12
3.6.3.2	Monitoring Wells .....	3-13
3.6.3.3	Prototype Percolation Line Testing.....	3-13
3.6.4	Drywell Testing .....	3-15
3.6.4.1	Drywell Installation.....	3-15
3.6.4.2	Monitoring Wells .....	3-16
3.6.4.3	Prototype Drywell Testing.....	3-16
3.6.5	Previous Prototype Test Results .....	3-18
3.6.5.1	M&E (1996a) Prototype Percolation Ponds .....	3-19
3.6.5.2	M&E (1997) Prototype Drywell Testing.....	3-19
3.7	GENERAL CONDITIONS AND LIMITATIONS.....	3-20
4.	SITE CONDITIONS .....	4-1
4.1	GEOLOGIC SETTING .....	4-1
4.2	FAULTING.....	4-1
4.3	SEISMIC CONDITIONS .....	4-2
4.3.1	Historical Seismicity.....	4-2





4.3.2	Probabilistic Seismic Hazards Analysis .....	4-3
4.3.2.1	Background.....	4-3
4.3.2.2	Methodology .....	4-3
4.3.2.3	Peak Horizontal Ground Accelerations .....	4-4
4.3.2.4	Site Response Spectra .....	4-5
4.3.2.5	Spectral Values for Long Periods .....	4-5
4.4	SUBSURFACE CONDITIONS.....	4-6
4.4.1	Pipeline Areas.....	4-6
4.4.1.1	Pavement Conditions.....	4-6
4.4.1.2	Soil Conditions .....	4-9
4.4.2	Pump Stations and Standby Power Buildings.....	4-12
4.4.3	Tri W Wastewater Treatment Plant.....	4-14
4.4.4	Effluent Disposal Sites .....	4-15
4.4.4.1	Broderson Site .....	4-15
4.4.4.2	Santa Maria Avenue Site .....	4-16
4.4.4.3	Pismo Avenue Site.....	4-17
4.5	GROUNDWATER CONDITIONS .....	4-17
5.	GEOLOGIC HAZARDS ASSESSMENT .....	5-1
5.1	FAULT RUPTURE .....	5-1
5.2	STRONG GROUND MOTIONS.....	5-1
5.3	LANDSLIDES AND SLOPE STABILITY.....	5-1
5.3.1	Slope Stability Evaluation for Reinforced Retaining Walls.....	5-1
5.3.1.1	Slope Stability Criteria.....	5-1
5.3.1.2	Approach .....	5-2
5.3.1.3	Summary of Slope Stability Results.....	5-2
5.4	GROUND LURCHING .....	5-4
5.5	EXPANSIVE SOIL .....	5-4
5.6	TSUNAMIS AND SEICHES.....	5-4
5.7	SOIL EROSION .....	5-5
5.8	LIQUEFACTION AND SEISMIC SETTLEMENT .....	5-7
5.8.1	San Simeon Earthquake.....	5-7
5.8.2	Pipeline Network.....	5-8
5.8.3	Pump Stations and Standby Power Buildings.....	5-9
5.8.4	Tri-W Treatment Plant Site .....	5-9
5.8.5	Effluent Disposal Systems .....	5-10
5.8.5.1	Broderson Site .....	5-10
5.8.5.2	Pismo and Santa Maria Sites.....	5-11
6.	CONCLUSIONS AND RECOMMENDATIONS.....	6-1
6.1	SUMMARY OF FINDINGS .....	6-1
6.2	GRADING – GENERAL.....	6-2
6.2.1	Grading.....	6-2
6.2.2	Suggested Material Specifications.....	6-3





6.2.3	Clearing and Grubbing.....	6-6
6.2.4	Fill Placement.....	6-6
6.3	SEISMIC CONSIDERATIONS.....	6-7
6.3.1	Seismic Data.....	6-7
6.3.2	Liquefaction and Seismic Settlement.....	6-7
6.3.3	Fault Rupture Hazards.....	6-8
6.4	PIPELINE NETWORK.....	6-9
6.4.1	Backfill Considerations.....	6-9
6.4.2	Use of On-site Materials.....	6-9
6.4.3	Foundation Support and Trench Bottom Stabilization.....	6-10
6.4.4	Pipe Zone Bedding Material.....	6-11
6.4.5	Pipe Zone Material.....	6-11
6.4.6	Trench Backfill.....	6-12
6.4.7	Backfill and Compaction.....	6-12
6.4.7.1	Mechanical Compaction.....	6-12
6.4.7.2	Jetting and Ponding.....	6-13
6.4.8	Pavement Structural Section Design.....	6-14
6.4.9	Trenchless Installations.....	6-15
6.4.9.1	Soil and Groundwater Conditions.....	6-15
6.4.9.2	Boring Tolerances.....	6-15
6.4.9.3	Jacking Resistance.....	6-16
6.4.9.4	Monitoring and Instrumentation.....	6-16
6.4.9.5	Post-Installation Grouting.....	6-17
6.4.9.6	Environmental Considerations.....	6-17
6.4.10	Thrust Resistance.....	6-18
6.4.11	Backfill Loading on Pipe.....	6-18
6.4.12	Modulus of Soil Reaction (E').....	6-19
6.4.13	Construction Considerations.....	6-20
6.4.13.1	Excavation.....	6-20
6.4.13.2	Dewatering.....	6-20
6.4.13.3	Temporary Slopes.....	6-21
6.4.13.4	Shoring.....	6-22
6.4.13.5	Soil Properties.....	6-23
6.4.13.6	Existing Structures.....	6-23
6.5	PUMP STATION DESIGN.....	6-24
6.5.1	Wet Wells and Vaults.....	6-24
6.5.1.1	Lateral Earth Pressures.....	6-24
6.5.1.2	Uplift Forces.....	6-24
6.5.1.3	Construction Considerations.....	6-24
6.5.2	Standby Power Buildings.....	6-25
6.5.2.1	Site Preparation and Grading.....	6-25
6.5.2.2	Foundation and Slab Design.....	6-27
6.6	TRI W WASTEWATER TREATMENT PLANT.....	6-28
6.6.1	Site Preparation and Grading.....	6-28





6.6.2	Foundation Design.....	6-29
6.6.3	Resistance to Uplift Loads.....	6-29
6.6.4	Resistance to Lateral Loads.....	6-29
6.6.5	Slab-on-grade.....	6-30
6.6.6	Earth Retaining Structures.....	6-30
6.6.7	Dynamic Earth Pressures.....	6-32
6.6.8	Segmental Masonry Unit (SMU) Retaining Walls.....	6-34
6.6.8.1	Geosynthetic Reinforcement and Facing.....	6-34
6.6.8.2	Placement of Reinforcement.....	6-35
6.6.8.3	Wall Drainage and Backfill.....	6-35
6.6.9	Sedimentation Basin Geosynthetic Reinforced Slope.....	6-36
6.6.9.1	Geosynthetic Reinforcement and Spacing.....	6-36
6.6.9.2	Slope Drainage and Backfill.....	6-36
6.6.9.3	Boulder Facing.....	6-37
6.6.10	Basin Design.....	6-38
6.6.10.1	Slope Design.....	6-38
6.6.10.2	Percolation.....	6-38
6.6.11	Pavement Design.....	6-40
6.6.11.1	Subgrade Preparation.....	6-40
6.6.11.2	Asphalt Pavements.....	6-40
6.6.11.3	Portland Cement Concrete Pavements.....	6-40
6.6.12	Utility Trenches.....	6-40
6.6.13	Drainage Considerations.....	6-41
6.6.14	Erosion.....	6-41
6.6.15	Groundwater Considerations.....	6-41
6.7	<b>EFFLUENT DISPOSAL SYSTEM DESIGN.....</b>	<b>6-42</b>
6.7.1	Percolation Lines.....	6-42
6.7.1.1	Percolation Trench Design.....	6-42
6.7.1.2	Construction Considerations.....	6-43
6.7.2	Drywells.....	6-43
6.7.2.1	Drywell Design.....	6-43
6.7.2.2	Construction Considerations.....	6-44
6.7.3	Expansion Areas.....	6-44
6.7.4	Hydrogeologic Considerations.....	6-44
6.7.5	Operation and Post-Construction Monitoring.....	6-45
7.	<b>CONTINUATION OF SERVICES.....</b>	<b>7-1</b>
8.	<b>REFERENCES.....</b>	<b>8-1</b>





## PLATES

	No.
Vicinity Map.....	1
Cumulative Field Exploration Plan .....	2a
Field Exploration Plan for Tri W Treatment Plant.....	2b
Field Exploration Plan – Percolation Tests .....	2c
Field Exploration Plan – Prototype Test Site at Broderson.....	2d
Prototype Percolation Line Detail.....	3a
Prototype Drywell Detail.....	3b
Summary of Prototype Test Results – Percolation Line.....	4a
Summary of Prototype Test Results – Drywell.....	4b
Summary of Prototype Test Results – Drywell Percolation.....	4c
Summary of Prototype Drywell Testing– HP-1.....	4d
Regional Geologic Map.....	5a
Regional Fault Map.....	5b
Results of Probabilistic Seismic Hazard Analysis .....	6a to 6b
Design Response Spectra for 10% Chance of Exceedance in 50 Years.....	6c
Design Response Spectra for 10% Chance of Exceedance in 100 Years.....	6d
Subsurface Profile A-A' for Tri W Wastewater Treatment Plant Site.....	7a
Subsurface Profile B-B' for Tri W Wastewater Treatment Plant Site.....	7b
Subsurface Profile C-C' for Broderson Disposal Site.....	7c
Subsurface Profile D-D' for Prototype Drywell Site .....	7d
Groundwater Contour Map – 1990 Groundwater Elevations .....	8a
Groundwater Contour Map –1997-2003 Groundwater Elevations .....	8b
Groundwater Contour Map – Depth to 1997-2003 Groundwater .....	8c
Schematic Trench Section .....	9
Selected Photographs from Trenching.....	10a to 10g
Lateral Earth Pressures on Cylindrical Buried Structures .....	11
Typical Percolation Line Detail.....	13a
Typical Drywell Detail.....	13b

## APPENDIX A – FIELD EXPLORATION LOGS

Key To Terms & Symbols Used On Boring Logs.....	A-1
Log of Drill Hole Nos. DH-401 through DH-412 .....	A-2 through A-13
Log of Hand Auger Borings HA-401 through HA-403 .....	A-14 through A-16
Log of Drywell No. DW-1 .....	A-17
Log of Hydroprobe Well Nos. HP-1 and HP-2 .....	A-18 and A-19
Log of MW-3 and MW-4 .....	A-20 through A-21
Soil Classification Chart .....	A-22
Log of CPT Soundings CPT-4-1 through CPT-413 .....	A-23 through A-35





### APPENDIX B – LABORATORY TEST RESULTS

Summary of Laboratory Test Results.....	B-1
Grain Size Curves .....	B-2
Plasticity Chart .....	B-3
Direct Shear Test Results .....	B-4a through B-4d
Compaction Test Results .....	B-5a through B-5f
Consolidation Test Results .....	B-6a through B-6d

### APPENDIX C – SLOPE STABILITY RESULTS

Slope Stability Results .....	C-1 through C-4
-------------------------------	-----------------

### APPENDIX D – LIQUEFACTION RESULTS

Log CPT Sounding CPT-401 to CPT-413 .....	D-1 through D-13
Log of CPT-01 to CPT-16 .....	D-14 through D-29
Log of Gregg CPT-02 to CPT-04 .....	D-30 through D-32
Key to CPT Logs .....	D-33

### VOLUME 2– PREVIOUS FIELD AND LABORATORY DATA (SUBMITTED UNDER SEPARATE COVER)

	No.
CFS (2000a) Borings Logs.....	A1
CFS (2000a) Laboratory Data.....	A2
CFS (2000b) Borings Logs.....	B1
CFS (2000b) CPT/CPTU Logs.....	B2
CFS (2000b) Laboratory Data.....	B3
FUGRO WEST, INC. (1997) Borings Logs .....	C1
FUGRO WEST, INC. (1997) CPT/CPTU Logs.....	C2
FUGRO WEST, INC. (1997) Test Pit Logs .....	C3
FUGRO WEST, INC. (1997) Laboratory Data .....	C4
FUGRO WEST, INC./M&E (1996) Boring Logs .....	D1
FUGRO WEST, INC. (1996) CPT/CPTU Logs.....	D2
FUGRO WEST, INC. (1996) Laboratory Data .....	D3







## 1. PROJECT DESCRIPTION

The project will generally consist of providing a new community-wide wastewater collection and treatment plant system for the unincorporated areas of Los Osos, Baywood Park, and Cuesta-by-the-Sea in San Luis Obispo County, California as described by MWH (2001, 2002, 2003a). Currently individual septic systems are being used in these communities. The project will consist of constructing a new pipeline network with associated pump stations, a wastewater treatment plant, and an effluent disposal system. The location of the project relative to various streets and landmarks is shown on Plate 1 – Vicinity Map. The layout of the new treatment plant, effluent disposal systems, and pipeline network for the project is shown on Plate 2a.

### 1.1 PIPELINE NETWORK

We understand that the pipeline network will consist of approximately 40 miles of gravity flow sewer pipe, and between 17,000 and 20,000 linear feet of sewer force main. The approximate limits of the pipeline network are shown on Plate 2a - Cumulative Field Exploration Plan.

We understand that it is expected that the pipeline will generally be constructed using conventional cut and cover techniques for pipeline construction. We expect that jack and bore techniques could be used to assist in the installation of the pipeline across the busier streets within the project limits, such as Los Osos Valley Road and South Bay Boulevard. However, we understand that no constraints that could preclude the use of cut and cover techniques in all areas of the project have been identified at this time.

The pipeline is designed to provide a minimum of 3 feet of soil cover over the top of the pipe on secondary roads, and 4 feet of soil cover over the pipe in primary roads. However, it is generally expected that the sewer will have an invert elevation of at least 5 feet below the existing ground surface. The depth of sewer lines will likely vary over the site, and it is expected that cuts of up to approximately 15 to 30 feet will be needed in some areas.

### 1.2 PUMP STATIONS

The MWH (2003a) plans show that seven primary pump stations are anticipated within the collection system to "lift" collected wastewater into the gravity collection system. In addition, approximately 18 pocket type pump stations will be provided at various locations to help limit trench depths where the existing terrain is relatively low compared with adjacent areas. These pump stations will generally consist of a wet well, vault, soil filter, electrical supply, and standby power building. MWH (2003a) plans show a typical wet well as a buried cylindrical concrete structure approximately 12 feet in diameter. The invert to of wells is typically 15 feet below the existing ground surface; however, depths of up to 20 feet below the existing ground surface could be needed in some areas. The anticipated pump station locations are shown on Plate 2a – Cumulative Field Exploration Plan.





Additionally, there will be approximately 20 smaller pocket pump stations in various areas of the site, primarily to serve residents on dead end streets near shoreline of Morro Bay and north of Santa Ysabel Avenue, and low lying areas in the Mountain View-San Luis Avenue area. The pocket pump stations will be approximately 10 feet in diameter and extend to depths of approximately 10 to 15 feet below the existing ground surface.

### 1.3 TRI W WASTEWATER TREATMENT PLANT

The treatment plant will generally consist of a new wastewater treatment plant designed to accept an estimated peak flow of 1.6-million gallons per day. The treatment plant will be constructed at the Tri W site. The plant will include an operations building, offices, a septage receiving station, headworks, solids processing, tertiary treatment and filter systems, aeration basins, and clarifiers. The site drainage systems will include sedimentation, detention and percolation ponds. The plant will be designed in association with creating a recreational facility for the surrounding communities. Appurtenant improvements will generally consist of paved access roads and parking areas, utilities, retaining walls, a dog park, trails, and playfields. The layout of the treatment facility is shown on Plate 2b - Field Exploration Plan for Proposed Tri W Treatment Plant.

The main part of the treatment facility will be constructed in a cut. Site grading will include cuts and fills to provide a relatively flat area for the proposed facility. The ground surface at the completed facility will likely be approximately elevation (el.) 73 to 75 feet. Site grading will involve cuts and fills of approximately 10 feet with respect to the existing site grades. The approximate finish grades are indicated on Plate 2b. An approximately 20-foot high earth retention system wall will be constructed along east and south sides of the main facility. The retention system is likely to be constructed of segmental masonry units (SMU) with supporting geosynthetic reinforcement.

*no clarifiers  
or these  
elevations  
correct?*

We understand that the operations building will be a single-story steel and concrete-framed building with slab-on-grade floors. The finished floor elevation will be approximately el. 75 feet, approximately 1 to 2 feet above existing site grades.

We understand that the residuals building will be a two-story building of concrete- and steel-framed construction with slab-on-grade floors. The finished floor elevation will be approximately el. 74 feet, which is approximately 4 feet below existing site grades along the east side of the building and approximately 1 foot above existing site grades along the west side of the building.

The treatment building will house the aeration basins and clarifiers and be constructed of reinforced concrete. The clarifiers will be approximately 50 feet in diameter, and will extend to approximately 6 to 10 feet below finish grades. The aeration basins will be housed in a partially buried vault type structure, approximately 220 feet long and 110 feet wide. The aeration basins will be covered with earth to form a dog park, with the southern end of the basins constructed completely below grade, and north end exposed into the main treatment plant facility.





On-site drainage will consist of constructing 3.5 acres of ponds to provide for sediment removal, detention, and percolation of storm water. The finish grading for the ponds is shown on Plate 2b. The ponds will be excavated to approximately 5 to 15 feet below the existing ground surface. Retaining walls, turf, and erosion control systems will be constructed in association with the ponds. The main percolation pond will serve dual use for playing fields.

#### 1.4 EFFLUENT DISPOSAL SITES

A system of percolation lines and drywells will be used to dispose of the treated effluent discharged from the treatment plant. The effluent will be pumped to the effluent disposal sites via a pressured pipeline. Twelve potential disposal sites have been identified in MWH (2003a, 2003c) to dispose of an average of 1.2 MGD of treated effluent. The primary effluent disposal sites are Broderson, Santa Maria, Pismo, and Sea Pines. The remaining sites have been deferred for future effluent disposal, if needed. The locations of the proposed effluent disposal sites are shown on Plate 2a – Cumulative Field Exploration Plan.

A leach line generally consists of a buried line that consists of an excavated trench, gravel backfill, a perforated pipe laid level on top of the gravel to allow for effluent to be distributed to the trench, and a soil cover. A drywell generally consists of a vertically drilled shaft, gravel backfill, a vertical perforated pipe to allow distribution of effluent into the well, a concrete surface seal, and a soil cover. The effluent sites are listed in the table below, along with type, estimated size, and capacity. The locations of the potential effluent disposal sites are shown on Plate 2a.

Site	Type	Area (ft <sup>2</sup> )	Capacity (GPD)
Broderson	Percolation Lines	440,000	810,000
Santa Maria Avenue	Drywells	68,000	160,000
Pismo Street	Drywells	92,000	160,000
Sea Pines	Irrigation	NA	30,000
Vista de Oro	Percolation Lines	7,300	Deferred
Monarch Grove School	Existing Lines	52,8000	Deferred
Pine Avenue	Percolation Lines	30,000	Deferred
Broderson Avenue	Percolation Lines	30,000	Deferred
Los Osos Middle School	Existing Lines	20,000	Deferred
East El Morro Avenue	Percolation Lines	20,000	Deferred
East Ysabel	Percolation Lines	20,000	Deferred
South Bay Boulevard	Percolation Lines	40,000	Deferred





## 2. SITE DESCRIPTION

The Los Osos Wastewater project is located in the unincorporated communities of Los Osos, Baywood Park, and Cuesta-by-the-Sea in San Luis Obispo County, California. The site is generally bounded by Morro Bay to the west and north, the Los Osos Valley to the east, and the Irish Hills to the south. The location of the site and the limits of the proposed improvements are shown on Plate 1 - Vicinity Map.

### 2.1 PIPELINE NETWORK

The Los Osos Wastewater pipeline network is generally located within existing County streets and right-of-ways in the unincorporated communities of Los Osos, Baywood Park and Cuesta-by-the-Sea. The site encompasses approximately 5 square miles of these communities. The pipeline network is generally bound within the limits of the south shore of Morro Bay to the north, South Bay Boulevard to the east, the Sea Pines Golf Course to the west, and Highland Drive to the south. The general layout of the pipeline network is shown on Plate 2a - Cumulative Field Exploration Plan.

The site has been developed predominantly as residential neighborhoods. Associated with these developments are the downtown areas of Baywood, near the intersection of Santa Maria Avenue and 2<sup>nd</sup> Street, and Los Osos, along Los Osos Valley Road between approximately South Bay Boulevard and Doris Avenue. The downtown areas support commercial and light industrial development that serves the surrounding communities.

Elevations within the proposed pipeline network range from approximately sea level along the shoreline of Morro Bay, to approximately el. 200 feet at the southern end of the site near Highland Avenue, which bounds the Broderson infiltration basin site. The existing site grades can be divided into two general areas, which are the areas east and west of the extension of Ferrell Avenue. Some topographic information is shown on Plate 1 - Vicinity Map and Plates 2a and 2b.

West of Ferrell Avenue the existing topography generally slopes to the northwest towards Morro Bay. The inclination of the existing topography between Highland Avenue and Morro Bay averages about 3 to 4 percent in this area. At the time of the Fugro (1997) field exploration program, springs along some of the streets that front Morro Bay were observed. An open inlet to Morro Bay crosses the pipeline alignment on Doris Avenue between the intersections of Lupine Street and Binscarth Road.

East of Ferrell Avenue the existing topography generally consists of rolling sand hills, which are bound by Morro Bay to the north, the Irish Hills to the South, and Los Osos Creek to the east. The tops of the hills are generally less than about el. 100 to 125 feet. At least two depressions traverse the area east of Ferrell Avenue in a generally northwest-southeast direction. The depressions are generally located along Pismo and Paso Robles Avenue, and along Ramona Avenue. The hills in this area generally form dune shaped mounds that also trend in a northwest-southeast direction, consistent with the direction of local prevailing winds.





At the time of the Fugro (1997) field exploration program, springs along some of the streets that front Morro Bay were observed.

## 2.2 PUMP STATIONS

Two pump stations are located along the west side of the project area, near Morro Bay, with the five pump stations within the east side of the project area. The areas for each pump station are relatively small (about 6000 square feet). The areas for each pump station are located in relatively clear lots covered with grass, low shrubs, and occasional trees. The pump station sites are shown on Plate 2a.

## 2.3 TRI W WASTEWATER TREATMENT PLANT

The Tri W wastewater treatment plant site is located northwest of the intersection of Los Osos Valley Road and Palisades Avenue, between Palisades Avenue and the planned extension of Ravenna Avenue. The site is bordered by open fields to the north and west, Los Osos Valley Road to the South, and Palisades Avenue and the San Luis Obispo County Public Library to the east. The location of the Tri W site is shown on Plate 2b –Field Exploration Plan for Proposed Tri W Treatment Plant.

The site encompasses a roughly trapezoidal-shaped parcel of approximately 11-acres. The site is presently undeveloped. Vegetation at the site generally consists of grass, low shrubs and areas of trees. The terrain in the site vicinity consists of relatively low undulating sand hills. Several eroded drainages pass through the site. The site elevations generally range from approximately el. 104 feet near the southeastern corner of the site near the intersection of Palisades Avenue and Los Osos Valley Road, to approximately el. 70 feet near the northwestern end of the site. The existing ground surface generally slopes downward to the northwest at approximately 2 to 7 percent towards Morro Bay.

## 2.4 EFFLUENT DISPOSAL SITES

The primary effluent disposal sites are Broderson, Santa Maria, Pismo, and Sea Pines (see Plate 2a). A summary of the existing site conditions at the various sites is presented below:

**Broderson.** The Broderson effluent disposal site is located on an undeveloped site south of Highland Avenue, near its intersection with Broderson Avenue (see Plate 2d). The site is within a relatively large undeveloped area with vacant properties to the east, west, and south. The Broderson site encompasses a rectangular-shaped parcel of approximately 10-acres. Vegetation at the site generally consists of high shrubs, some grasses and rows of trees. The existing site topography generally consists of a north-facing hillside with site elevations ranging from approximately el. 220 feet along the northern boundary of the site, to approximately el. 260 feet along the southern boundary of the site. The existing site grades generally slope downward to the north at approximately 10 percent. Several eroded drainages, approximately 5 to 6 feet deep, pass through the site in a generally north-south direction.



**Santa Maria Avenue.** This site runs approximately 2,500 feet along Santa Maria Avenue, between 13th Street and 18th Street. With the exception of west of 12th Street, the site is predominantly an unpaved roadway. Residential dwellings, trees, and low shrubs are adjacent to the roadway. The site is generally located near the ridge of a predominant stabilized dune in this area that extends to approximately el. 150 feet. The existing ground surface along the roadway ranges from approximately el. 120 feet at the east end of the site to approximately el. 140 feet at the west end of the site.

**Pismo Avenue.** This site runs approximately 2,300 feet along Pismo Street, between 7th Street and 15th Street. This area is predominantly an unpaved road section and paper streets with residential dwellings, trees, and low shrubs adjacent to the street. The existing site topography consists of undulating hills that range in elevation from approximately el. 75 feet near the west end of the site to approximately el. 115 feet.

**Sea Pines.** This site is the Sea Pines Resort and Golf Course. This site will generally serve as a user of reclaimed water.

A series of effluent disposal sites that have been deferred for future use are the Vista de Oro, Monarch Grove School, Pine-Broderson Avenues, Los Osos Middle School, El Morro Avenue, Santa Ysabel, and South Bay Boulevard sites (see Plate 2a).

- ❖ The Vista de Oro effluent disposal site is located on a 7,300-square-foot parcel of land located northeast of the intersection of Montana Way and Los Osos Valley Road. The site currently has community septic and leachline improvements. The site is relatively level at an elevation of approximately 88 to 90 feet, and drops to an elevation of approximately 82 feet at the southern corner.
- ❖ The Monarch Grove School site consists of existing leach lines that can be converted for use as effluent disposal. That site is an existing school located north of Los Osos Valley Road, between the streets of Doris Avenue and Pecho Road.
- ❖ The Pine Avenue-Broderson sites are located along approximately 500 feet of Pine Avenue and Broderson Avenue, between Los Osos Valley Road and Rosina Drive.
- ❖ The Los Osos Middle School site consists of existing leach lines that can be converted for use as effluent disposal. That site is an existing school located east of South Bay Boulevard, south of the intersection with El Morro Street.
- ❖ The El Morro site runs approximately 1,500 feet along the extension of El Morro Avenue, east of South Bay Boulevard.
- ❖ The East Ysabel site runs approximately 500 feet along the extension of Santa Ysabel Avenue, east of the intersection with Scenic Way.
- ❖ The South Bay Boulevard runs approximately 1,000 feet along the east side of South Bay Boulevard, north of Santa Ysabel Avenue. The existing site topography is relatively flat at approximately el. 90 feet, with a steep slope that rises to approximately el. 105 feet at the northern end of the proposed effluent disposal lines.



### 3. WORK PERFORMED

#### 3.1 PURPOSE

The purpose of this report is to summarize available data at the site, perform supplementary geotechnical investigations to evaluate the soil conditions at the site, and to prepare this Geotechnical Report for the design of the Los Osos Wastewater Project. On the basis of our evaluation, we have provided geotechnical opinions and recommendations for the design of the pipeline collection system, pump stations, wastewater treatment plant, and effluent disposal sites for the project.

#### 3.2 SCOPE

A summary of the work presented in this report as the follows:

- ❖ Collecting data from previous explorations and laboratory testing programs and reproducing as Attachments (Vol. 2);
- ❖ Evaluating field and laboratory tests, assessing and organizing data, and reviewing the project objectives with MWH;
- ❖ Performing a field exploration program consisting of:
  - Drilling 12 hollow stem auger borings (DH-401 through 412);
  - Advancing 13 cone penetration test soundings (CPT-401 through CPT-413);
  - Drilling 3 hand auger explorations (HA-401 through HA-403);
  - Performing 9 double-ring infiltrometer tests;
  - Performing 31 percolation tests;
  - Constructing, testing, and monitoring a prototype percolation line and installing three monitoring wells; and
  - Constructing, testing, and monitoring a prototype drywell and installing two monitoring wells
- ❖ Preparing this written report with graphics. On the basis of the data available for the site, we have provided our geotechnical opinions and recommendations regarding:
  - Geologic conditions;
  - Soil and groundwater conditions encountered (groundwater elevation maps are prepared based predominantly on Spring 1997 and Spring 1990 data);
  - Expansive soils;





- Bedding, pipe zone backfill, trench backfill and seismic considerations for pipelines
- Thrust resistance from passive resistance and soil-pipe friction;
- Backfill loading on pipes;
- Modulus of soil reaction,  $E'$ ;
- Construction considerations for excavation, construction of temporary slopes or shoring systems, need for dewatering, and stabilization of subgrades to receive fill or bedding;
- Foundation design including allowable bearing pressures for shallow foundations, minimum foundation widths and depths, and the estimated total and differential settlements for pump/lift stations and treatment plant buildings;
- Passive resistance and friction coefficient for resistance to lateral loads;
- Lateral earth pressures for retaining wall and pump/lift station design;
- Suitability of excavated materials for use as fill or backfill material;
- Requirements for imported fill materials;
- Application and percolation rates based on results of field percolation and prototype testing for effluent disposal system;
- Geotechnical considerations for trenchless technology methods, such as directional drilling, microtunneling, and jacking and boring;
- Potential for geologic hazards (for example, slope instability, liquefaction, faulting, seismic shaking, or subsidence) to impact the site according to the requirements of the California Division of Mines and Geology Note 48;
- Site preparation, grading, and drainage;
- Earthwork factors for on-site soil when excavated and replaced as compacted fill;
- Fill placement and compaction requirements;
- Design of cut and fill slopes and erosion control considerations;
- Considerations for the design of the retention ponds such as depth to groundwater, soil permeability, and soil excavation characteristics;
- Preparation and geotechnical considerations for slopes to receive liners;
- Ground motion parameters for seismic design including causative fault(s), maximum moment magnitude, ground acceleration, soil profile type, and distance from site for use with the building code, and including:





- History of seismicity in the project region;
  - Earthquake occurrence and the estimated probabilistic peak ground accelerations having a 10 percent probability of being exceeded in a 50-year and 100-year period;
  - Ground motion parameters for seismic design including causative fault, maximum moment magnitude, ground acceleration, soil profile type, and distance from site for use with the building code;
  - Considerations for near field (short period) and far field (long period) earthquakes;
  - Plotted response spectra (pseudo acceleration, displacement, and velocity) for critical damping of 0.5, 2, 5 and 10 percent, and extrapolated to a period of 15 seconds; and
  - Seismic increment of active earth pressure.
- ❖ Pavement recommendations for parking lots and access roads based on traffic indices (TI) provided to us; and
  - ❖ Design of slab on grade.

Four copies of the report will be submitted. Field and laboratory data obtained from our previous evaluation will be included in the report. We may recommend that additional exploration or evaluation be performed based on the results of the work performed.

### 3.3 PREVIOUS STUDIES

To assist in preparing this report we have reviewed preliminary geotechnical and groundwater information (Fugro 1997, 1997; M&E, 1997; CFS 2000a, 2000b). Field and laboratory data used in the preparation of this report is mainly based on previous information obtained for this study. The principal sources of material are summarized below:

- ❖ Fugro (1996) provided limited geotechnical engineering services for the Broderson infiltration site. Those services consisted of performing CPT soundings and laboratory testing of samples from adjacent borings at the site as input to a hydrogeologic study and borings performed by M&E (1995, 1997), and preliminarily evaluating the potential for liquefaction at that site. The evaluation generally indicated that the potential for liquefaction appears to be relatively low; with the exception of relatively loose near-surface soils that were encountered and could be susceptible to liquefaction in the event that the near-surface soils were saturated at the time of an earthquake.
- ❖ The former Fugro environmental group assisted the County in evaluating the environmental constraints for the project. A constraints study performed for the wastewater treatment plant is summarized in the Fugro (1996b) report.





- ❖ Fugro (1997) performed a field exploration and laboratory testing program for the project, and submitted a draft geotechnical report for the County's design of the pipeline network, wastewater treatment plant located at the Pismo site, and the Broderson infiltration basin. The design for that project was terminated following submittal of the draft report.
- ❖ Another study, performed for the County of San Luis Obispo concurrent with the previous sewer project was a drainage study performed by Engineering Development Associates and the Morro Group (1997). Groundwater and geologic information presented in that report was used to supplement the information we obtained for the site.
- ❖ CFS (2000a, 2000b) performed a field exploration and laboratory testing program for the Los Osos CSD for geotechnical characterization related to the Morro Shores site. The initial study was submitted as a draft Geotechnical Report, and provided recommendations for the design of a pond system that would have occupied essentially the entire 100-acre Morro Shores site. Supplemental borings and laboratory testing were then performed for the CSD to address the revised treatment plant design at the Tri W site. The latter geotechnical program was terminated before a report was prepared for the project.

Information from various published documents and maps were also used to assist in preparing this report. Published information, and the studies indicated above, are referenced in this report.

### **3.4 FIELD EXPLORATION**

The geotechnical investigation for the project included programs of field exploration, laboratory testing, and engineering evaluation. Previous field exploration consisted of drilling and sampling 55 hollow-stem-auger borings and 14 hand-auger borings; performing 99 electric cone penetration test (CPT) soundings; excavating 7 trenches at the site, percolation testing, prototype percolation line testing, and prototype drywell testing. A supplemental field exploration program consisted of hollow stem auger borings, CPT soundings, field percolation testing, field double-ring infiltrometer testing, installing and testing a prototype drywell and prototype percolation line. Laboratory tests were performed on selected samples obtained from the borings and trenches. Previous field and laboratory data obtained for the project are presented in Volume 2 of this report. The locations of the previous and supplemental field tests and explorations are shown on Plates 2a through 2d for the cumulative field exploration program, percolation testing, Tri-W Treatment Plant Site, and the Broderson Effluent Disposal Site, respectively.

#### **3.4.1 Drilling**

With the exception of B-1 drilled at the Tri-W site, the drilling subcontractor for the project was S/G Drilling Company of Lompoc, California. S/G used a CME75, truck-mounted drill rig equipped with 8 1/4-inch hollow stem augers to advance the borings. Gregg Drilling and Testing Inc. of Signal Hill, California advanced one hollow stem auger boring (B-1) using a





track-mounted hollow stem auger rig equipped with 7-inch hollow stem auger. The hollow stem auger borings were advanced to depths ranging from approximately 15 feet to 165 feet below the existing ground surface.

The borings were sampled using an unlined 2-inch outside diameter standard penetration test (SPT) split spoon sampler, and a 3-inch outside diameter modified California split spoon sampler. The modified California sampler was used with brass liners. The split spoon samplers were driven in to the materials at the bottom of the drill hole using a 140-pound automatic trip hammer with a 30-inch drop. The blow count (N-value) is the number of blows from the hammer that were needed to drive the sampler 1 foot, after the sampler had been seated at least 6 inches into the material at the bottom of the hole. Bulk samples were collected from the drill cuttings retrieved from the auger flights. The sample intervals, N-values, and a description of the subsurface conditions encountered are presented on the logs of the borings in the Volume 2 attachments, and in Appendix A for the supplement drilling performed for the current phase of work.

### **3.4.2 Cone Penetration Testing**

Cone penetration test (CPT) soundings were advanced at the project site by Fugro Geosciences of Santa Fe Springs, California and Gregg In Situ Inc. of Signal Hill, California. Fugro Geosciences performed 85 of the 99 CPT soundings performed for the project. Gregg In Situ performed the remaining 14 CPT soundings. The CPT soundings were performed using electric cone penetrometers and piezocone penetrometers. The penetrometers were advanced into the ground using a hydraulic ram mounted in a truck having a weight of approximately 20 to 25 tons. The cone and piezocone penetrometers have a diameter of approximately 1.7 inches. Cone tip resistance ( $q_c$ ) and sleeve friction ( $f_s$ ) were recorded on the penetrometer during all CPT soundings. The porewater pressure during penetration was measured behind the tip ( $u_2$ ) in piezocone soundings. Data was recorded at approximately 2 cm intervals using an on-board computer to provide a near-continuous profile of the soil conditions encountered during penetration. The friction ratio (FR) was computed for each value of  $q_c$  and  $f_s$  recorded. The data was retrieved electronically for use in subsequent geotechnical analyses. CPT data and soil behavior type classifications were used in conjunction with boring information to evaluate the subsurface conditions encountered at the site. CPT soundings were advanced to depths ranging from approximately 15 feet to 69 feet below the ground surface. Plots of CPT sounding data are presented in the Volume 2 attachments, and with the boring log data in Appendix A for the supplemental field exploration performed for the current phase of work.

### **3.4.3 Hand Auger Borings**

The hand auger borings for this project were performed by a field engineer using a 3 to 4 inch, outside diameter, hand auger. The hand auger borings were drilled to depths ranging from approximately 5 to 32 feet below the existing ground surface. Hand auger borings were performed to supplement soil data obtained from the drilling and CPT soundings, install monitoring wells, and locate the groundwater depth at various locations. The sample intervals and a description of the subsurface conditions encountered are presented on the logs of the





borings in the Volume 2 attachments, and in Appendix A for the supplement drilling performed for the current phase of work.

#### **3.4.4 Backhoe Trenches**

Ed's Excavating of Los Osos, California performed the backhoe trenches for this project. The excavation subcontractor used a rubber-tired backhoe with a 3-foot bucket to excavate the test trenches to depths ranging from approximately 6 to 16 feet deep and approximately 12 feet long. Backhoe trench T-106 was excavated to approximately 25 feet long. The excavations were performed under the observation of a staff engineer of Fugro, who prepared logs of the soil conditions encountered and obtained soil samples for laboratory observation and testing. The backhoe trenches were excavated until excessive caving and sloughing was observed, then backfilled with native material. The backfill was compacted with the backhoe bucket up to 5 feet below finish grade. A hand compactor was then used to compact the backfill to finish grade.

Bulk and grab samples were collected during the course of the trench excavations by taking samples obtained from the excavated cuttings and trench side walls. The bulk samples were selected for classification and testing purposes and represent a mixture of soils within the noted depths. Recovered samples were bagged and returned to the laboratory for further classification and testing.

### **3.5 LABORATORY TESTING**

Laboratory tests for unit weight, moisture content, grain size distribution, Atterberg (plasticity) limits, compaction characteristics, consolidation properties, sand equivalent (SE), hydraulic conductivity, direct shear strength, R-value, and corrosion potential were performed as part of this program. Health Sciences Associates of Las Alamitas, California performed the corrosion tests. The tests were performed in general accordance with the applicable standards of ASTM. Laboratory test results from previous studies are presented in the Volume 2 attachments to this report. Supplemental laboratory data that was obtained during the current phase of work are presented in Appendix B.





### 3.6 PROTOTYPE TESTING FOR EFFLUENT DISPOSAL SYSTEM

#### 3.6.1 Percolation Testing

Percolation testing was performed by Fugro at proposed effluent disposal sites during the period of January 1 through March 25, 2003. The approximate locations of percolation tests and effluent disposal sites are shown on Plate 2c. The results of the laboratory tests performed on soil samples obtained from percolation test locations are presented in Appendix B. The results are generally typical of well-drained, sandy soil with percolation rates predominantly faster than 1 minute per inch. A summary of the field percolation test data is also presented below.

**Summary of Percolation Testing for Effluent Disposal Sites**

No.	Location	Soil Type	% Fines	Permeability x 0.001 cm/sec H= horizontal	Percolation Rate for 12" squ. Hole (min./in)
P-1	Santa Maria Avenue, 72 feet east of 17 <sup>th</sup> Street	Sand (SP)	–	8.4	0.75
P-2	Santa Maria Avenue, 140 feet west of 16 <sup>th</sup> Street	Sand (SP)	1	–	0.44
P-3	Santa Maria Avenue, 172 feet west of 15 <sup>th</sup> Street	Sand (SP)	–	–	0.43
P-4	Santa Maria Avenue, 75 feet east of 13 <sup>th</sup> Street	Sand (SP)	–	–	0.55
P-5	18 <sup>th</sup> Street, 85 feet north of El Morro Avenue	Sand (SP)	–	–	0.29
P-6	18 <sup>th</sup> Street, 265 feet north of El Morro Avenue	Sand (SP)	0.5	–	0.26
P-7	18 <sup>th</sup> Street, 455' north of El Morro Avenue	Sand (SP)	–	10	0.55
P-8	Intersection of 18 <sup>th</sup> Street and Santa Maria Avenue	Sand (SP)	–	–	0.35
P-9	South Bay Boulevard, 65' north of San Ysabel Avenue	Sand (SP)	–	–	1.1
P-10	South Bay Boulevard, 350 feet north of San Ysabel Avenue	Sand (SP)	0.5	–	0.22
P-11	South Bay Boulevard, 650 feet north of San Ysabel Avenue	Sand (SP)	–	–	0.22
P-12	South Bay Boulevard, 950 feet north of San Ysabel Avenue	Sand (SP)	–	5.4	0.32
P-13	Pismo Avenue, 110 feet east of 14 <sup>th</sup> Street	Sand (SP)	–	–	0.38





No.	Location	Soil Type	% Fines	Permeability x 0.001 cm/sec H= horizontal	Percolation Rate for 12" squ. Hole (min./in)
P-14	Pismo Avenue, 150 feet east of 12 <sup>th</sup> Street	Sand (SP)	1	--	0.39
P-15	Pismo Avenue, 85 feet west of 11 <sup>th</sup> Street	Sand (SP)	--	--	0.37
P-16	Pismo Avenue foot path, 55 feet east of 8 <sup>th</sup> Street	Sand (SP)	--	9.8	0.44
P-17	Pine Avenue, 100 feet south of Rosina Drive	Sand (SP)	0.8	4.4	0.82
P-18	Pine Avenue, 390 feet north of Los Osos Valley Road	Sand (SP)	--	--	0.42
P-19	Pine Avenue, 250 feet north of Los Osos Valley Road	Sand (SP)	--	--	0.43
P-20	Pine Avenue, 45 feet north of Los Osos Valley Road	Sand (SP)	--	--	0.59
P-21	Santa Ysabel Avenue, 40 feet east of Scenic Way	Sand (SP)	--	--	0.22
P-22	Santa Ysabel Avenue, 170 feet east of Scenic Way	Sand (SP)	--	--	0.29
P-23	Santa Ysabel Avenue, 300 feet east of Scenic Way	Sand (SP)	--	8.4	0.42
P-24	Santa Ysabel Avenue, 430 feet east of Scenic Way	Sand (SP)	0.9	--	0.35
P-25	Northwest corner of Broderson site	Sand (SP)	--	--	0.75
P-26	Southwest corner of Broderson site	Sand (SP)	--	3.3	1.5
P-27	Southeast portion of Broderson site	Sand (SP)	--	--	0.75
P-28	Northeast corner of Broderson site	Sand (SP)	2	--	0.76
L-1	West end of Prototype Percolation Line at Broderson site	Sand with silt (SP-SM)	--	6.2	0.63
L-2	Middle of Prototype Percolation Line at Broderson site	Sand (SP)	--	6.4	0.73
L-3	East end of Prototype Percolation Line at Broderson site	Sand with silt (SP-SM)	2	--	0.76





No.	Location	Soil Type	% Fines	Permeability x 0.001 cm/sec H= horizontal	Percolation Rate for 12" Squ. Hole (min./in)
PPL #S-1	Prototype Percolation Line at Broderson Site	Sand (SP)	-	(H) 7.4	-
PPL #S-4	Prototype Percolation Line at Broderson Site	Sand (SP)	-	(H) = 8.5	-

As suggested in Resolution No. 83-12 from the California Regional Water Quality Control Board Central Coast Region (the Basin Plan), percolation tests were conducted in general accordance with procedures outlined in Guidelines for Evapotranspiration Systems (State Water Resources Control Board 1980). Circular 6-inch diameter test holes were excavated by hand to depths of approximately 5 feet below the adjacent ground surface. A hand driven or grab sample was typically obtained over the depth interval from 4-1/2 to 5 feet and preserved for subsequent laboratory testing. Laboratory testing consisting of sieve analysis, fines content, and falling head permeability was performed on selected samples obtained from the perc test holes.

After the final depth was reached, a 6-inch diameter PVC casing was inserted to the bottom of the perc test hole. The lower 1-foot of the casing was perforated to allow percolation, and wrapped with filter fabric to prevent soil migration into the casing. Approximately 2 inches of 3/4-inch gravel was placed at the bottom of the hole to prevent scour while water was added to the test hole. A ball float connected to a 7-foot long rod was then placed in the hole to allow for water measurement readings. Water was added to the hole to a level of 1 foot above the gravel layer and allowed to percolate into the soil to presoak the test hole. This initial 1-foot of water then percolated into the soil prior to actual timed testing. Since water drained from the hole in less than 10 minutes during presoaking, a longer presoak was unnecessary and percolation testing was initiated.

Water was then added to the hole until a water level of 6 inches above the gravel layer was observed. The time for the water level in the hole to drop approximately 2 inches was measured and recorded. After each 2-inch drop in water level, water was added to the six-inch level and the test was repeated. The field percolation rate was estimated as the the time it took for the drop to occur (in minutes) over the drop in the water level over during that period (inches). The resulting percolation rate is expressed in minutes per inch. Testing was concluded when the percolation rates varied by less than 10 percent for 3 consecutive readings. A Ryon factor of 1.66 times the field percolation rate was used to convert the measured rate to an equivalent percolation rate for a 12-inch square test hole. Upon completion of percolation testing, the casing was removed and the hole was backfilled with the excavated materials.

### 3.6.2 Double Ring Infiltrometer Testing

Double ring infiltrometer testing was performed by Fugro at the proposed wastewater treatment plant site and the Sea Pines Golf Resort during the period of September 22 through October 16, 2003. Testing was performed at the proposed wastewater treatment plant site to assess the infiltration rates at the site and provide geotechnical input to the design of the multi-use area. Testing was performed at the Sea Pines Golf Resort to provide a comparative





baseline to assess the influence of landscaping turf on infiltration rates. Except for the presence of landscaped turf at the Sea Pines Golf Resort, both sites have similar soil conditions. Percolation tests were performed at each double ring infiltration test location. The approximate locations of double ring infiltrometer and percolation tests are shown on Plate 2c. Permeability and grain size distribution tests were performed on selected samples obtained from each double ring infiltrometer test location. A summary of the field double ring infiltrometer ("DR" test numbers) and corresponding perc test ("P" test numbers) data is presented below.

**Summary of Double-Ring Infiltrometer – Percolation Testing**

No.	Depth (feet)	Location	Soil Type at Depth of Test	% Fines	Permeability x 0.001 cm/sec	Percolation Rate (min./in)
DR-3W1	1	Proposed Wastewater Treatment Plant, 270 feet west of Palisades Rd., and 150 feet north of LOVR	Sand with silt (SP-SM)	--	--	6.8
P-3W1	5	same as DR-3W1	Sand (SP)	5	--	0.57
DR-3W2	0.8	Proposed Wastewater Treatment Plant, 500 feet west of Palisades Rd., and 150 feet north of LOVR	Silty SAND (SM)	--	--	19
DR-3W2A	1.5	same as DR-3W2	Sand (SP)	--	--	3.9
P-3W2	5	same as DR-3W2	Sand (SP)	5	9.7	0.36
DR-3W3	1.2	Proposed Wastewater Treatment Plant, 550 feet west of Palisades Rd., and 250 feet north of LOVR	Sand (SP)	--	--	3.9
P-3W3	5	same as DR-3W3	Sand (SP)	0.5	11.2	0.44
DR-SP1	0	Sea Pines Golf Resort, 250 feet north of Skyline Dr., and 550 feet west of Solano St.	Turf over sand with silt (SP-SM)	--	--	12
DR-SP1A	0.6	same as DR-SP1 with turf removed	Sand with silt (SP-SM)	--	--	20
P-SP1	5	same as DR-SP1	Sand (SP)	1	3.5	0.40
DR-SP2	0	Sea Pines Golf Resort, 160 feet west and 200 feet south of the terminus of Howard Ave into Sea Pines.	Turf over sand with silt (SP-SM)	--	--	6.0
DR-SP2A	0.6	same as DR-SP2 with turf removed	Sand (SP)	--	--	6.0
P-SP2	5	same as DR-SP2	Sand (SP)	3	5.4	0.22
DR-SP3	0	Sea Pines Golf Resort, 40 feet north of the intersection of Howard Ave and Humbolt St...	Turf over sandy organic SILT (OH)	--	--	36
DR-SP3A	0.6	same as DR-SP3 with turf removed	Sand (SP)	--	--	35
P-SP3	5	same as DR-SP3	Sand (SP)	0.5	--	0.39

Note 1) Percolation rates for percolation tests (designated by P-XXX) have been calculated for a 12" square hole.







Double-ring infiltrometer tests were performed in general accordance with ASTM D 3385-94, Standard Test Method for Infiltration Rate of Soils in Field Using Double-Ring Infiltrometer. A general description of the procedure followed is provided below.

Double-ring infiltrometer tests were performed at the proposed wastewater treatment plant site in the area designated as multi-use. Prior to testing, loose topsoil was removed from the ground surface to depths ranging from 10 inches to 18 inches below the ground surface. The bottom of the excavation was cut to a level grade in undisturbed soil with a square-tip shovel. A 24-inch inner diameter steel ring was driven to 6 inches below the adjacent ground surface with an 8-pound hammer. A 12-inch inner diameter steel ring was placed in the center of the 24-inch ring, and driven 3 inches into the ground with the hammer. Soil disturbed during ring advancement was carefully tamped to a firm consistency.

A water-filled reservoir and associated tubing was used to convey water into each of the rings. The rings were filled with water to a depth of 2 inches above the ground surface. Water levels within the rings were maintained at a height of two inches above the ground surface by manually controlling the flow into each ring. Time readings were recorded as known volumes of water were introduced into each ring. Tests were continued until a relatively constant flow rate was obtained within the inner ring. Percolation rates provided in the table above were calculated based on the relatively constant flow rate obtained during each test. After completion of the double-ring infiltrometer test, the rings were removed and a percolation test was performed using the procedures described in this report at a depth of 5 feet below the location of the double-ring infiltrometer test. The excavation was backfilled with excavated materials after completion of the perc test.

Double-ring infiltrometer tests were performed at the Sea Pines Golf Resort to provide a comparative baseline to assess the influence of landscaping turf on infiltration rates. At the Golf Resort, two double-ring infiltrometer tests were performed at each testing location. The first test was performed at the ground surface through the existing turf using the same procedure described above. After completion of the first test, the rings were removed, the turf was removed from the test location, and a circular pit was excavated neatly to a depth of 7 inches below the ground surface into undisturbed soil. The bottom of the excavation was cut to a level grade with a square-tip shovel. A second double-ring infiltrometer test was then performed with the excavation and below the turf that was removed.

After completion of the second double-ring infiltrometer test, the rings were removed and a percolation test was conducted. Percolation tests were performed at a depth of 5 feet below grade at the test location. The excavation was backfilled with excavated materials after completion of the testing. The turf was replaced over the excavation and the testing location was restored.

### **3.6.3 Prototype Percolation Line**

A prototype percolation line was installed and tested near the north end of the Broderson site on February 28, 2003. The location of the prototype percolation test line and previous prototype test sites performed by Metcalf & Eddy (1996a) are shown on Plate 2d. The





subcontractor used to install the test line was Ed's Excavating of Los Osos, California. Ed's Excavating installed and provided materials for the prototype percolation test line. The Morro Group observed the work for compliance with environmental permits, cleared areas in advance of the work, and provided biological monitoring. Fugro observed and documented the installation, and obtained soil samples for laboratory testing. Perc testing and soil samples were obtained from the test line location in advance of the installation as described in the previous section of this report.

### **3.6.3.1 Line Installation**

Details of the prototype percolation line showing the layout, typical profile, and typical trench section are presented on Plate 3a. The test line was approximately 50 feet long, 3 feet wide, with 3 feet of gravel below the distribution pipe. Ed's Excavating used a New Holland 655E rubber-tired backhoe equipped with a 36 - inch bucket to perform the excavation. Gravel consisting of 1-1/2-inch crushed stone was obtained from Windsor Sand and Gravel, and hauled to the site in a dump truck. A Cat 926 front-end loader was used to transport gravel from the street to the test site, and backfill the prototype percolation line with the gravel. Pipe used in construction of the test line consisted of 4-inch PVC sewer line, ASTM D3034, with 3/8-inch diameter perforations.

A sieve analysis performed on a sample of the gravel is presented in Appendix B. Based on those results, the gravel was predominantly 1-1/2 minus by 3/4-inch plus crushed stone with approximately 1 percent fines (particles smaller than 0.075 millimeters). Some rock dust and sand sized material was observed within the crushed gravel during placement.

The trench was excavated in dune sand deposits to a relatively level grade at a depth of approximately 5 to 7 feet below the ground surface. The trench excavation and gravel placement was performed in about 10-foot long segments to avoid caving of the sidewalls. Essentially no caving or sloughing of the sidewalls was observed during the construction of the test line.

Vertical observation ports (designated OP on Plate 3a) constructed of 4-inch-diameter perforated pipe were placed within the gravel at approximately 10-foot horizontal intervals along the trench. The observation ports extended from the ground surface to the bottom of the trench. A solid riser and cap were added to secure the observation ports, and allow for observation of the water level in the trench during subsequent testing.

The 4-inch PVC distribution pipe was laid level over the gravel with perforations facing downward. Three inlet/observation ports were placed within the distribution pipe. An additional 1-foot of gravel was then placed over the gravel and distribution pipe. A geotextile was then placed over the top of the gravel, and about 2 feet of on-site soil backfill was placed over the geotextile to finish grade.



### **3.6.3.2 Monitoring Wells**

Four monitoring wells (MW-1 through MW-4) were installed adjacent to the test trench, see Plates 2d and 3a. MW-1 and MW-2 were installed in 4-inch diameter hand auger borings extending to approximately 32 feet below the existing ground surface. MW-1 was installed immediately adjacent to and near the midpoint of the test line on downhill side. MW-2 was installed approximately 10 feet downslope of MW-1. A series of 3 piezometers constructed of ¾-inch PVC pipe were installed in each boring. The piezometers had a 6-inch perforated section covered with filter fabric. The piezometers were installed to depths of approximately 10 feet, 20 feet and 32 feet below the existing ground surface based on review of the CPT-8 log (Fugro 1996). The piezometers were packed in native dune sand. A 2-foot thick cement grout seal was provided above each piezometer depth.

MW-3 and MW-4 were installed in 4-inch diameter hand auger borings extending to approximately 10 feet below the existing ground surface. MW-3 and MW-4 were constructed as piezometers with the bottom 12 to 18-inch section of the pipe perforated and covered with filter fabric. The piezometers were installed 16 feet and 250 feet downslope of the east end of the test line. The piezometers were packed in native dune sand.

### **3.6.3.3 Prototype Percolation Line Testing**

The prototype testing was performed during the period of March 19 through April 25, 2003. Water for testing was obtained from Cal Cities Water using a metered hydrant on Highland Avenue adjacent to the site. Water was conveyed to the test site via plastic pipe, metered at the point of discharge into the prototype leachline, and maintained at a relatively constant rate during various testing intervals. Prior to testing, the line was flushed with water to attempt to wash sand and silt from the gravel, and allow fines to settle to the bottom of the trench. During testing the flow rate into the test line ranged from 1.1 to 29 gallons per minute. A total of approximately 1,000,000 gallons of water was discharged into the test trench over a period of 37 days.

The application rate of the water was evaluated by incrementally increasing the flow rate into the trench. The flow rate ( $Q$ ) at each increment was maintained until water levels in the trench or monitoring wells stabilized to a constant level. The rate was increased incrementally until the application rate exceeded the maximum infiltration capacity of the trench at approximately 29 gpm. The maximum infiltration capacity of the trench was characterized by a constant and sudden rise in the water level in the observation ports at that rate. The water flow into the trench was then reduced to prevent the water from overflowing the trench. The net infiltration rate of the trench was estimated as the discharge into the trench divided by the estimated wetted surface area of the trench, expressed in gallons per day per square foot of trench ( $\text{gpd}/\text{ft}^2$ ). A summary of the test results is presented in the table below:





### Prototype Percolation Line Results

Flow into Trench, $q$ (gpm)	Duration (days)	High Water Depth in OP's, (in.)	High Water Depth in MW1 at 10' (in.)	High Water Depth in MW1 at 20' (in.)	High Water Depth in MW2 at 20', (in.)	Net Infiltration Rate (gpd/ft <sup>2</sup> )	Comment
—	½	0	0	0	0	—	Flushed line prior to testing
1.1	½	0	0	0	0	53	
3.2	1	2"	0	0	0	158	Water in OP1 only.
6.0	3	3	0	0	0	128	Water in OP1 and OP2 only
9.1	8	3¼	2	16	0	187	Water in OP1 and OP2 only
9.1	11	2	0	0	0	87	Water being distributed into distribution line at all 3 locations. Water in OP1 and OP5 only.
29	1 hour	11	63	33	63	180	Terminated due rising water level. Water in all OP. Water passed through MW and OP over 24 hours.
16	3	4.5	25	33	21	175	Water in OP1 through 4
24	9	8	30	43	38	190	Water in OP1 through 4

A plot of the results in terms of the average head of water over the wetted portion of the trench versus the net infiltration rate over the wetted portion of the trench is presented on Plate 4a. The maximum infiltration rate obtained from the test is approximately 180 gpd/ft<sup>2</sup>. The values are plotted to plus or minus 25 gpd/ft<sup>2</sup>. Above approximately 180 gpd/ft<sup>2</sup>, the water level in the test trench is expected to rise and overwhelm the available surface area of the trench. The tests do not include potential influences associated with biological fowling or clogging of the gravel that could be associated with long term use of the trench.

Mounding of water below the percolation line trench was observed in MW-1 at depths of 10 feet and 20 feet below the existing ground surface, and in MW-2 at a depth of 20 feet. No water was observed during testing in MW-1 at 32 feet, or MW-2 at 10 feet and 32 feet below the existing ground surface. The mounding observed in MW-1 at 10 and 20 feet, initiated at a flow rate of approximately 9 gpm. However, no water was observed in the MW-1 piezometers when the flow was directed to 3 points within the distribution line (in the middle, and at each end of the line) instead of the 1 point at the east end of the line. Redirecting the flow to 3 points effectively reduced the application rate in the trench from approximately 187 to 87 gpd/ft<sup>2</sup>. Mounding was observed in MW-2 at 20 feet, at the 29 gpm flow rate increment, which appears to have exceeded the infiltration capacity of the trench. Mounding subsequently continued when the flow rate was reduced to 16 and 24 gpm.



### 3.6.4 Drywell Testing

A prototype drywell was installed and tested near the intersection of Santa Maria Avenue and 18<sup>th</sup> Street. The location of the prototype drywell is shown on Plate 2a. Previous prototype drywell test sites performed by Metcalf & Eddy (1996a, 1996b) are shown on Plate 2d. The subcontractor for the drywell construction was Tri Valley Drilling of Ventura, California. The Morro Group observed the work for compliance with environmental permits and cleared areas in advance of the work. Fugro assisted in the installation, observed and documented the drywell construction, and obtained soil samples for laboratory testing. Mr. Kevin Kai (MWH) also observed the installation of the prototype drywell. Cone penetration testing was performed at the site prior to the drywell installation, and is presented with the other CPT data in Appendix A. Hydroprobe casings were installed in drill holes advanced approximately 11 feet and 53 feet downslope from the drywell subsequent to the drywell installation. The borings were logged and sampled prior to installing hydroprobe monitoring casings.

#### 3.6.4.1 Drywell Installation

Tri Valley used a Caldwell 75 drill rig equipped with a 3-foot diameter bucket auger to drill the hole for the drywell's construction. The hole was drilled to approximately 26 feet below the existing ground surface, and then reamed to 4 feet in diameter to approximately 23 feet below the existing ground surface. A 6-inch diameter pipe with 0.08-inch slots was then lowered into the center of the drilled hole to serve as a water injection point. Gravel, 3/8-inch size, was supplied by Hanson's Aggregate of Morro Bay. The gravel was placed in the hole to approximately 5 feet below the ground surface from the chute of a concrete redi-mix truck. A layer of visqueen was then placed over the top of the gravel, and a 5-foot thick concrete surface seal was placed over the visqueen to the ground surface.

A detail of the prototype drywell is presented on Plate 3b. A log of the drill hole (DW-1) is presented in Appendix A. Approximately 1-foot of relatively dense aggregate base with pieces of asphalt and concrete rubble was encountered in DW-1. The underlying material consisted of dune sand to the maximum depth of the drywell, approximately 26 feet below the existing ground surface. The dune sand consisted of sand with silt (SP-SM) and sand (SP). No caving or sloughing of the sidewalls was observed during the construction of the drywell.

A vertical observation port (designated OP on Plate 3b) constructed of 2-inch diameter slotted PVC pipe was placed in the drill hole. The observation port extended from the bottom of the drywell to the ground surface. The observation port was pushed to the edge of the drywell during the placement of the gravel. The observation port allowed for monitoring of the water level in the drywell during subsequent testing. A 2-inch tee was connected to the 6-inch diameter pipe that was connected to the water source.

**Hydroprobe Installation.** Two hydroprobe casings were installed (HP-1 and HP2) to assist with monitoring the drywell testing. The hydroprobe casings were located approximately 11 feet and 53 feet down slope from the drywell (DW-1). The hydroprobe casings were installed in 8-inch diameter hollow stem auger borings drilled to depths of approximately 50 feet below the existing ground surface.





The drilling subcontractor for the drilling and casing installation was S/G Drilling Company of Lompoc, California. The borings were advanced using a CME 75 truck-mounted drill rig equipped with 8-inch hollow stem augers. The borings were sampled at 5-foot intervals using standard penetration test (SPT) and modified California split spoon samplers as previously discussed in Section 3.4.3 of this report. Fugro logged the borings, obtained soil samples, and documented the hydroprobe casing installation. Logs of the borings (HP-1 and HP-2) are presented in appendix A.

The hydroprobe casings consisted of 2-3/8 inch outside diameter schedule 40 cold rolled steel pipe. The 50-foot casing consisted of 3 sections of pipe (two 21-foot sections and one 8-foot section) joined together with threaded couplings. The casing was capped on the bottom and lowered into the boring subsequent to the completion of drilling. Native sand from the boring was backfilled through the hollow stem augers and compacted in approximately 1 to 2 foot lifts using the augers. A 1.5-foot thick concrete surface seal was placed at the top of the borehole.

The soil moisture conditions were monitored using a CPN 503 DR Hydroprobe. The hydroprobe is a portable radioactive source (50mCi Americium-241-beryllium) that is lowered into the casing and measures hydrogen content (water content) of the surrounding soil at selected depths. The hydroprobe source emits fast neutrons that have the same mass as the hydrogen atoms in water. The fast neutrons collide with the hydrogen atoms in the water and are slowed down and rebounded back to and detected/measured by the probe. The probe is connected to a cable that is attached to a recording device that displays and stores the data at the surface.

Soil moisture conditions were recorded prior to, and during drywell testing. Soil moisture conditions were monitored and recorded during the drywell testing. Soil moisture conditions were monitored at 2-foot intervals from 1-foot to 49 feet below the existing ground surface. A summary of the hydroprobe readings and plots of the soil moisture conditions versus depth are presented on Plates 4d and 4e.

#### **3.6.4.2 Monitoring Wells**

An existing monitoring well (30S/11E-8mb) was previously installed by Cleath & Associates at the north end of 18<sup>th</sup> Street, approximately 230 feet down slope of the prototype drywell. The boring for the monitoring well is reported to have been drilled to a depth of 75 feet below the existing ground surface. The monitoring well was constructed to 47 feet below the existing ground surface. The depth to water prior to the drywell testing was measured at 42.5 feet below the existing ground surface on October 6, 2003. The water depth in the monitoring well was measured and recorded during the drywell testing. The water depth varied between 37 feet and 42 feet below the existing ground surface during the drywell testing.

#### **3.6.4.3 Prototype Drywell Testing**

The prototype drywell testing was performed during the period of October 6 through November 20, 2003. The test results are summarized on Plates 4b and 4c. Water for the





testing was obtained from Los Osos Community Service District using a metered hydrant on Santa Maria Avenue at 18<sup>th</sup> Street. Water was conveyed to the test site via a 2-inch diameter PVC pipe, and maintained at a relatively constant rate during various testing intervals.

A total of approximately 654,800 cubic feet (4,898,000 gallons) of water was discharged into the drywell over a period of 45 days. Water was initially discharged into the drywell at approximately 53 gpm and then increased to approximately 110 gpm. The flow rate (Q) at each increment was maintained until the water levels and soil moisture conditions in the drywell and hydroprobe casings stabilized. The water level in the Cleath monitoring well continued to rise during the testing, but appeared to have stabilized during the last week of the drywell testing.

After the test stabilized at 110 gpm the water to the well was turned off, the water in the well was allowed to completely percolate into the ground, and the water level was then restored by discharging water back into the well. The cycling was performed 4 times in one day, allowing the well to go completely dry during each cycle. The cycling was performed to simulate on and off cycles that drywells will likely experience during the operation of the effluent disposal system. We used the cycling to evaluate the potential for the in-situ dune sand to migrate into the gravel in the well. The application rate of 110 gpm was again allowed to stabilize. The well was cycled a total of 10 times using 4 on and off intervals for each cycle. The water level in the drywell typically increased above the initial water depth in the drywell when the flow rate was restored.

After October 31, 2003, the flow rate into the drywell was kept below 55 gallons per minute (gpm) at the request of the District due to reduced reservoir storage levels that they were observing in the area of the testing. Water was observed leaking from the base of the fire hydrant on November 4. The testing was suspended between the November 4 and 7, 2003 while the district repaired the leak. The net infiltration rate of the well was estimated as the total volume of water discharged into the well per day divided by the wetted surface area of the well, expressed in gallons per day per square foot of well (gpd/ft<sup>2</sup>). A summary of the test results follows:

### Summary of Prototype Drywell Testing

Discharge Rate into Drywell (gpm)	Duration (days)	Water Depth in drywell (ft)	Net Infiltration Rate (gpd/ft <sup>2</sup> )	Comment
0	NA	0		Start of test
53	1.9	19.5	970	
110	8.1	16.3	1330	
112	11	12.2	945	After 1 <sup>st</sup> cycle of drywell
111	1.9	9.8	800	After 2 <sup>nd</sup> cycle of drywell
46	3.0	15.8	527	After 3 <sup>rd</sup> cycle of drywell. After reducing Q to ~50 gpm at request of LOCSD.
0	3.0	0	na	Water turned off for 3 days to repair leak in fire hydrant.





Discharge Rate into Drywell (gpm)	Duration (days)	Water Depth in drywell (ft)	Net Infiltration Rate (gpd/ft <sup>2</sup> )	Comment
44	3.0	16.8	565	After 4 <sup>th</sup> cycle of drywell.
47	0.95	15.5	521	After 5 <sup>th</sup> cycle of drywell.
41	5.4	17.0	530	After 6 <sup>th</sup> cycle of drywell.
48	3.1	15.8	554	After 7 <sup>th</sup> cycle of drywell.
55	0.97	14.0	531	After 8 <sup>th</sup> cycle of drywell.
49	1.0	16.0	515	After 9 <sup>th</sup> cycle of drywell.
46	0.98	15.0	520	After 10 <sup>th</sup> cycle of drywell. End of drywell testing.

Plots summarizing the drywell testing, cyclic testing, and hydroprobe readings for HP-1 and HP-2 are presented on Plates 4b, 4c, 4d, and 4e, respectively. The initial application rates for the drywell tests ranged between 800 and 1,330 gpd/ft<sup>2</sup> over the wetted area of the drywell, with corresponding water depths in the drywell ranging between 6.5 and 16 feet above the bottom of the drywell. After cycling the drywell four times on 4 different days the application rate stabilized at approximately 515 to 565 gpd/ft<sup>2</sup> with water depths of 9 to 12 feet above the bottom of the drywell.

Mounding of water down slope of the drywell was inferred in HP-1 at approximately 17 to 23 feet below the existing ground surface. The water depth in HP-1 stabilized at approximately 21 feet below the existing ground surface. Mounding water was inferred in HP-2 at 42 to 48 feet below the existing ground surface. The water depth in HP-2 stabilized at approximately 46 feet below the existing ground surface. The water depth in the Cleath monitoring well located approximately 230 feet north of the drywell rose from approximately 42.5 feet to 37 feet below the existing ground surface while pumping water into the drywell at approximately 110 gpm. After reducing the flow into the well to approximately 45 to 55 gpm, the water depth in the monitoring well stabilized at 38 feet below the existing ground surface.

During cycling of the drywell, the 2-inch observation port that was pushed to the side of the drywell during the gravel placement sanded in to approximately 20 feet below the existing ground surface. No evidence of sand migrating to the center 6-inch diameter PVC injection pipe was observed during the cycling of the well. No evidence of ground subsidence was observed around the drywell.

### 3.6.5 Previous Prototype Test Results

Prototype drywell and percolation ponds were constructed and tested at the Broderson site by Metcalf & Eddy (1996a, 1996b, 1997). Fugro (1996a) assisted in the site characterization and laboratory testing for that study. We reviewed the results of the previous prototype testing to compare the infiltration rates reported by M&E to infiltration rates observed during the current prototype-testing program.







### **3.6.5.1 M&E (1996a) Prototype Percolation Ponds**

Percolation ponds were constructed in three areas of the Broderson site by M&E (1996a, see Plate 2d). The ponds were typically 10-foot square with the sidewalls lined with impervious plastic sheeting. The infiltration rate through the base of the ponds was reported to be approximately 240 gallons per day per square foot (gpd/ft<sup>2</sup>) in Basin 1, 345 gpd/ft<sup>2</sup> in Basin 4, and 135 gpd/ft<sup>2</sup> in Basin 5, with an average infiltration rate of approximately 240 gpd/ft<sup>2</sup>. The basin numbers correspond to the exploration numbers of the adjacent CPT and borings. The water depth in the ponds during the testing was between 0.85 and 2 feet.

With the exception of Basin 5, these infiltration rates are generally higher than the estimated 180-gpd/ft<sup>2</sup> rate recorded during the prototype percolation line testing. We attribute these differences mainly to the difference in infiltration area at the base of the test trench or pond with and without aggregate, respectively. Additionally, the testing of the ponds was performed only a limited period of time: 8 hours in Ponds 1 and 4, and 17 hours in Pond 5. The data presented in the M&E (1996a) study suggests that the reading had not stabilized at the time the tests were terminated.

### **3.6.5.2 M&E (1997) Prototype Drywell Testing**

Drywells were installed in two areas (DW-1 and DW-2) of the Broderson site by M&E (1997, see Plate 2d). DW1 was approximately 5 feet in diameter and 50 feet deep. DW2 was approximately 3.5 feet in diameter and 40 feet. The drywells were backfilled with ¼-inch pea gravel and a vertical 6-inch diameter distribution pipe extending the full depth of the trench. Neutron probes were installed to monitor changes in soil moisture conditions downslope of the wells. Approximately 40 to 50 gpm were pumped into the wells over a period of approximately 14 days.

We estimated application rates from the data reported by M&E (1997) to be approximately 127 and 273 gpd/ft<sup>2</sup> in DW1 and DW2, respectively. However, the neutron probe data show an area between approximately 35 and 45 feet below the existing ground surface where the infiltration into the ground was limited. Neglecting infiltration between these depths results in an infiltration rate of approximately 194 gpd/ft<sup>2</sup>. CPT soundings indicate that soil layers that appear to lower permeability aquitards are present between 35 and 45 feet in nearby CPT1 and CPT8. Additionally, the soils near DW2, the westerly end of the Broderson site, appear to have less lower permeability layers and resulting faster infiltration rates.





### **3.7 GENERAL CONDITIONS AND LIMITATIONS**

Fugro prepared the conclusions and professional opinions presented in this report in accordance with generally accepted geotechnical engineering principles and practices at the time and location this report was prepared. This statement is in lieu of all warranties, expressed or implied.

This report has been prepared for Montgomery Watson Harza and their authorized agents only. It may not contain sufficient information for the purposes of other parties or other uses. If any changes are made in the project as described in this report, the conclusions and recommendations contained in this report should not be considered valid unless Fugro reviews the changes and modifies and approves in writing the conclusions and recommendations of this report. This report and the drawings contained in this report are intended for design-input purposes; they are not intended to act as construction drawings or specifications.

Soil and rock deposits can vary in type, strength, and other geotechnical properties between points of observations and exploration. Additionally, groundwater and soil moisture conditions also can vary seasonally or for other reasons. Therefore, we do not and cannot have complete knowledge of the subsurface conditions underlying the site. The conclusions and recommendations presented in this report are based upon the findings at the points of exploration, interpolation and extrapolation of information between and beyond the points of observation, and are subject to confirmation based on the conditions revealed by construction.





## 4. SITE CONDITIONS

### 4.1 GEOLOGIC SETTING

The project area lies within the Los Osos Valley that is part of the Coast Ranges geologic and geomorphic province. That province consists of north-northwest-trending sedimentary, volcanic, and igneous rocks extending from the Transverse ranges to the south into northern California. Rocks of the Coast Ranges province are predominately of Jurassic and Cretaceous age; however, some pre-Jurassic, along with Paleocene-age to Recent rocks, are present. The surficial geology of the project vicinity, as mapped by Hall (1973) is shown on Plate 5a – Regional Geologic Map.

The Los Osos Valley and adjacent Irish Hills are the dominant geomorphic features within the project vicinity. The Los Osos Valley has formed in response to several tectonic processes that began prior to the Pliocene time (more than 5 million years ago). Prior to the Pliocene, the bedrock strata in the Los Osos area was folded into a east-west trending syncline (U-shaped fold) that has subsequently been filled with up to 1,000 feet of sediment during the Pliocene and Pleistocene periods. Concurrent with that deposition is uplift along the east-west striking Los Osos fault that forms the boundary between the Los Osos basin and adjacent Irish Hills (Plate 5a).

As shown on Plate 5a, the predominant geologic units exposed in the study area consist of surficial sediments comprised of dune sand deposits (Qs) and alluvium (Qal). These surficial sediments are primarily underlain by weakly consolidated units of the age-equivalent of Paso Robles Formation (Qpr) and Careaga Sandstone (Tca). The Paso Robles Formation and Careaga Formation are underlain by relatively impermeable basement rocks composed of Franciscan Formation (KJf) greywacke and metavolcanics; Pismo Formation shale; and Cretaceous age dacitic (Td) intrusives (California DWR 1989). Units of the Pismo Formation (Tp) and Franciscan Formation (KJf, KJg) are exposed on Irish Hills south of Los Osos as shown on Plate 5a.

### 4.2 FAULTING

Regional faulting in the site vicinity, as presented by PG&E (1988) is shown on Plate 5b. Active and potentially active faults as defined by the California Geologic Survey (CGS, formerly Division of Mines and Geology) are summarized in Section 4.3.2 of this report. Other potentially significant local faults include the Cambria, Huasna, Wilmar Avenue/Oceano, Nacimiento, and Santa Lucia Bank (Plate 5b). The Wilmar Avenue, Oceano and other coastal faults are group as the San Luis Range fault system by CGS.

The closest active fault (as defined by the CGS) in the site vicinity is the Los Osos fault zone (PG&E 1988, Lettis & Hall, 1990; Asquith, 1997). A segment of the fault is designated an Alquist-Priolo earthquake fault zone near the City of San Luis Obispo. Lettis & Hall (1990) describe the Los Osos fault zone as a series of discontinuous, subparallel and en echelon fault traces that extend from Hosgri fault offshore to Lopez Reservoir, a distance of about 35 miles. Lettis and Hall (1990) subdivided the fault zone into four segments: Estero Bay, Irish Hills,





Lopez Reservoir, and Newsom Ridge. The Irish Hills segment of the Los Osos fault is about 10 to 12 miles long and extends from Morro Bay eastward to San Luis Creek. This segment of the fault forms the boundary between the Los Osos Valley and the Irish Hills and has documented Holocene offset (PG&E 1988). Portions of the fault east of Los Osos (east of study area) have been zoned active by the CGS. Lettis and Hall (1990) indicate that the Irish Hills segment of the fault has recurrent movement in the late Pleistocene and Holocene with a long-term slip rate of 0.2 to 0.4 mm/yr.

Several authors, including the California Division of Water Resources (DWR, 1989) and Asquith (1997), mapped a northwest trending strand (locally referred to as Strand "B") of the Los Osos fault east of the project area. The presence of the Strand B fault mapped by DWR was interpreted by an inferred offset in relatively deep bedrock units and groundwater aquifers in the Los Osos area. Asquith (1997) presents a refined location for a portion of the Los Osos fault and the "Strand B" lineation based on differences in shallow groundwater elevations in the Los Osos area. As part of their 1999 geotechnical study, CFS Geotechnical Consultants, Inc. advanced various piezocone penetration tests (CPT) and borings to depths of about 30 to 40 feet across the inferred trace of "Strand B" as mapped by Asquith near Ferrell Road. This data, combined with the Fugro (1997) and various County of San Luis Obispo well data, suggest that the shallow groundwater is the result of groundwater that is perched on various shallow clay layers that pinch out in the vicinity of the mapped fault. The clay layers terminate near or east of Palisades Avenue. The inferred Strand B from these data is an embayed feature and not linear as inferred by previous investigations.

Cleath & Associates (2003a, 2003b, 2003c personnel communication with Spencer Harris (2003)) recently performed additional studies that included reviewing the DWR and Asquith reports, and performing pump tests in existing wells near the inferred Strand B on Palisades Avenue. Cleath reports that the inferred Strand B fault is not needed to characterize the structure of Los Osos Valley geology or groundwater basin. Further, pump testing of a well on Palisades Avenue near the County library did not show deflection of the drawdown cone of depression that would suggest the presence of a groundwater barrier that would prevent the horizontal flow of groundwater. As such the Strand B fault is not included in their groundwater model for basin, and there is low potential that the inferred fault exists.

## **4.3 SEISMIC CONDITIONS**

### **4.3.1 Historical Seismicity**

The project is located in a seismically active region of central California. Historical records indicate that the area has been subject to a number of seismic events over the course of the last 183 years (PG&E, 1988). From these references, examples of strong ground motion that have reportedly been experienced near the project area are the seismic events of 1830, 1857, 1913, 1916, 1917, 1966, and 1980.

The 1830 event is estimated to be an approximately M5 earthquake that occurred from a poorly located source near San Luis Obispo. The effects of the 1830 event were generally observed between the Los Osos and Rinconada faults. The 1857 event (the Fort Tejon





earthquake) occurred on the Mojave segment of the San Andreas fault, and reportedly resulted in damage in Central and Southern California. The 1913 event is estimated to be an approximately M5 earthquake that occurred along the southwestern margin of the San Luis/Pismo block near Arroyo Grande. The 1916 event is estimated to be an approximately M5 earthquake that occurred near Avila, possibly along the Los Osos fault or faults along the southwestern margin of the San Luis/Pismo block. The 1917 event is estimated to be an approximately M5 earthquake that occurred near Lopez Canyon between the Rinconada and West Huasna faults. The 1966 event (the Parkfield earthquake) is estimated to be an approximately M6 earthquake that occurred on the San Andreas fault. The 1980 event is estimated to be an approximately M5 earthquake that occurred offshore near Point Sal along the Casmalia fault zone, and near its intersection with the Hosgri fault.

2003 EARTHQUAKE  
6.5 M

#### 4.3.2 Probabilistic Seismic Hazards Analysis

##### 4.3.2.1 Background

The site coordinates (latitude and longitude) for the Los Osos Wastewater Treatment Plant site were estimated to be 35.3128° North and 120.8375° West, as measured from the current USGS Morro Bay (South) Quadrangle Map. These coordinates were used as input for probabilistic seismic hazard analyses that were performed to estimate peak horizontal ground acceleration and seismic response spectra (acceleration, velocity, and displacement) for the project site. The results of our seismic hazard analyses are described in the sections that follow.

##### 4.3.2.2 Methodology

The probabilistic seismic hazard evaluation for the site was performed using the computer program FRISKSP (Blake 2000) and the CDMG (1996) southern California fault database. The program FRISKSP is based on FRISK (McGuire 1978) and has been modified for the probabilistic estimation of seismic hazards using three-dimensional earthquake sources.

The intent of our evaluation was to estimate the strong ground motion that could result from earthquakes occurring on active and potentially active faults mapped within a 62-mile radius of the site. The fault search routine in FRISKSP found thirteen (13) active and potentially active mapped faults and fault segments within the 62-mile radius of the site. Summarized below are ten (10) faults and fault segments that were considered to be the most capable of producing high ground motion at the site. Additional information is presented in the CDMG (1996) fault database.





### Summary of Fault Characteristics

Fault	Approximate Distance From Site (mile)	Maximum Moment Magnitude ( $M_w$ )	Fault or Fault Segment Length (mile)	Slip Rate (mm/yr)
Los Osos	0.6	6.8	27	0.5 ± 0.4
Hosgri	7	7.3	107	2.5 ± 1.0
San Luis Range (S. Margin)	9	7.0	40	0.2 ± 0.1
Rinconada	16	7.3	117	1.0 ± 1.0
Casmalia (Orcutt Frontal Fault)	28	6.5	18	0.25 ± 0.2
Lions Head	33	6.6	26	0.02 ± 0.02
San Juan	37	7.0	42	1.0 ± 1.0
San Andreas (Cholame)	43	6.9	38	34 ± 5
San Andreas (1857 Rupture)	43	7.8	214	34 ± 5
Los Alamos -- Baseline	48	6.8	17	0.7 ± 0.7

FRISKSP was used to estimate peak horizontal ground accelerations and seismic response spectra for the following earthquake ground motions:

- ❖ **Design-Basis Earthquake Ground Motion:** An earthquake having a 10 percent chance of being exceeded in 50 years (Statistical Return Period ≈ 475 Years)
- ❖ **Upper-Bound Earthquake Ground Motion:** An earthquake having a 10 percent chance of being exceeded in 100 years (Statistical Return Period ≈ 949 Years)

Based on the subsurface conditions encountered, a Soil Profile Type "S<sub>D</sub>" was assigned to the treatment plant site. This soil profile type corresponds to stiff soil according to the California Building Code (2001). For our probabilistic seismic hazard evaluation we used the attenuation relationship proposed by Boore et al. (1997) assuming a NEHRP site class "D" designation. A site class "D" designation corresponds with Soil Profile Type "S<sub>D</sub>" and assumes that the material in the upper 100 feet of the site has an average shear wave velocity ranging between 600 and 1,200 feet per second (180 and 360 meters per second).

#### 4.3.2.3 Peak Horizontal Ground Accelerations

The peak horizontal ground accelerations estimated using probabilistic evaluation procedures for the above two design earthquake ground motions are presented below.



### Summary of Peak Ground Accelerations Estimated from Probabilistic Seismic Hazards Analyses

Ground Motion Parameter	Design-Basis Earthquake	Upper-Bound Earthquake
Peak Horizontal Ground Acceleration (PHGA)	0.37	0.50

Note: All acceleration values in units of g (32 ft/sec<sup>2</sup> or 9.81 m/s<sup>2</sup>)

The results of the probabilistic analyses are also summarized on Plates 6a and 6b. Plate 6a shows the probability of exceedance versus peak horizontal ground acceleration for exposure periods of 50 and 100 years, assuming 13 fault sources. Plate 6b shows the average return period versus peak horizontal ground acceleration assuming 13 faults sources. Also shown on Plate 6b are the results for select individual fault sources within 62 miles of the site. Either Plates 6a or 6b can be used to estimate the ground accelerations presented in the table above.

#### 4.3.2.4 Site Response Spectra

Probabilistic evaluation procedures were also used to estimate seismic response spectra for the Los Osos Wastewater Treatment Plant site assuming the site conditions and FRISKSP input parameters previously described. We estimated spectral accelerations (in g's) as a function of period for the design-basis and upper-bound earthquake ground motions. Values of spectral acceleration ( $S_a$ ), velocity ( $S_v$ ), and displacement ( $S_d$ ) are presented on Plates 6c and 6d for the design and upper bound earthquakes. Estimated values of spectral acceleration are reported for damping ratios of 0.5, 5 and 10 percent. The plates can be used to estimate design spectral values for specific design periods.

The Boore et al. (1997) attenuation relationship used as part of the probabilistic evaluation was developed assuming a spectral damping ratio of 5 percent. Attenuation relationships at other damping ratios have not usually been derived. Instead, a factor to adjust from 5 percent damping ratio to other damping ratios was used. The procedure and factors recommended by Idriss (1993) was used to adjust the 5 percent damping spectra for a damping ratio of 0.5 percent.

#### 4.3.2.5 Spectral Values for Long Periods

Empirical attenuation relationships such as the one developed by Boore et al. (1997) typically allow for the estimation of response spectral ordinates for periods up to 2 seconds. We understand that for this study spectral ordinates are required for design periods up to 15 seconds. Spectral values beyond a 2 second period were extrapolated using a straight line to an acceleration value of  $1/T$  for where T is the spectral period in seconds. The extrapolated data is shown with the response spectra information on Plates 6c and 6d.





#### 4.4 SUBSURFACE CONDITIONS

The description of the soil conditions is based on the results of the field exploration and laboratory testing programs reviewed for this report, and contained in the attachments (Volume 2). The soil conditions encountered generally consist of artificial fill materials, sand dune deposits, alluvium, estuarine deposits and Paso Robles Formation. The Paso Robles Formation is referred to as a formational material; however, this sedimentary rock although consolidated is non- or weakly cemented. The Paso Robles Formation is therefore described as a soil. A summary of the soil and groundwater conditions encountered in the pipeline, pump stations, treatment plant, and effluent disposal sites follows.

##### 4.4.1 Pipeline Areas

The pipeline areas are generally underlain by surficial sediments consisting of existing pavement and artificial fill material that overly dune sand, estuarine and alluvial deposits, underlain by Paso Robles Formation and Franciscan bedrock.

##### 4.4.1.1 Pavement Conditions

The existing streets within the proposed pipeline network have a combination of the dirt and asphalt concrete surfacing. The following table summarizes the existing pavement thicknesses encountered in our borings and in potholes performed by Miller Pipeline Corporation (2003), and the subgrade conditions at those locations. Borings and potholes are indicated by the DH and PH prefixes, respectively.

**Summary of Existing Pavement Thicknesses Encountered**

No.	Location	Date (mo.da.yr)	AC (inches)	AB (inches)	Subgrade	Other Tests SE = Sand Equivalent R = R-value #200 = fine content
DH-101	Pasadena Drive, south of Santa Lucia and 1 <sup>st</sup> Street	1.17.97	2	8	Sand (SP)	#200=2
DH-103	Southwest corner of Santa Maria and 4 <sup>th</sup> Street	1.17.97	1.75	11	Sand (SP)	
DH-104	East shoulder of 10 <sup>th</sup> Street (top of hill) between Santa Ynez Ysabel and Santa Maria	1.17.97	2	4	Sand (SP)	#200=1
DH-106	West shoulder of South Boulevard, 140 ft south of Santa Ysabel	1.23.97	4	6	Clayey Sand with gravel (SC)	#200=24
DH-107	East shoulder of 18 <sup>th</sup> Street, 50 ft north of Paso Robles Street	1.20.97	3.5	6	Sand (SP)	
DH-109	West shoulder of 9 <sup>th</sup> Street between El Morro and Paso Robles	1.17.97	1.5	NR	Silty Sand (SM)	







No.	Location	Date (mo.da.yr)	AC (inches)	AB (inches)	Subgrade	Other Tests SE = Sand Equivalent R = R-value #200 = fine content
DH-111	8 <sup>th</sup> Street, south of Ramona	1.20.97	2	6	Sand (SP)	#200=1
DH-112	North shoulder of Los Olivos, 50 ft east of 10 <sup>th</sup> Street	1.20.97	2.5	2	Sand with silt (SP-SM)	
DH-113	West lane of Mountain View, 150 ft north of Los Olivos	1.20.97	2.5	4	Silty Sand (SM)	
DH-114	South shoulder of Los Osos Valley Road, 80 ft east of Sunny Oaks mobile home park	1.23.97	5.5	NR	Sand (SP)	
DH-115	East lane of Pecho Road, 200 ft north of Los Osos Valley Road	1.24.97	2.5	6	Silty Sand (SM)	#200=13
DH-116	East lane of Solano Street at south Butte Drive intersection	1.24.97	2.5	6	Sand (SP)	#200=4
DH-403	13 <sup>th</sup> Street, 200 ft north of Santa Ysabel Avenue	8.11.03	3.25	8	Sand with silt (SP-SM)	
DH-406	Intersection of Santa Ynez Avenue and Mountain View Avenue	8.12.03	3	6	Silty Sand (SM)	
DH-407	South end of Green Oaks Drive; south of Crest Avenue	8.13.03	3	4.5	Silty Sand (SM)	
DH-408	Intersection of Bay Oaks Drive and Crest Avenue	8.13.03	4	8	Sand (SP)	
DH-409	Bay View Heights Drive, 75 ft north of Bay Oaks Drive	8.13.03	4	20	Sand (SP)	#200=2
DH-410	Intersection of Lilac Drive and Palisades Avenue	8.13.03	4	16	Silty Sand (SM)	
DH-411	Lilac Drive, 50ft east of Broderson Avenue	8.13.03	4.5	10.5	Sand (SP)	
DH-412	Lilac Drive, 300 ft west of Doris Avenue	8.13.03	4	5	Silty Sand (SM)	
PH-1	16 <sup>th</sup> Street	8.25.03	4	NR	Sand (SP)	
PH-2	12 <sup>th</sup> Street	8.25.03	3	NR	Sand (SP)	
PH-3	Pasadena Drive	8.25.03	8	NR	Sand (SP)	Concrete pavement
PH-4	Ravenna Avenue and Woodland Drive	8.26.03	7	NR	Sand (SP)	
PH-5	Ravenna Avenue and Highland Drive	8.26.03	6	NR	Sand (SP)	
PH-6	Bayview Heights Drive and Highland Drive	8.26.03	5	NR	Sand (SP)	





No.	Location	Date (mo.da.yr)	AC (inches)	AB (inches)	Subgrade	Other Tests SE = Sand Equivalent R = R-value #200 = fine content
PH-7	Pecho Road and Skyline Drive	8.26.03	4	NR	Sand (SP)	
PH-8	Pecho Road and Skyline Drive	8.26.03	7	NR	Sand (SP)	
PH-9	Don Avenue and Mitchell Drive	8.26.03	4	NR	Sand (SP)	
PH-10	10 <sup>th</sup> Street and Los Olivos Avenue	8.27.03	0	0	Sand with gravel (SP)	Unpaved Road
PH-11	Los Olivos Avenue and Fairchild Way	8.27.03	4	NR	Sand (SP)	
PH-12	Los Olivos Avenue and Mountain View Drive	8.27.03	5	NR	Sand (SP)	
PH-13	1620 11 <sup>th</sup> Street	8.27.03	0	0	Sand (SP)	Unpaved Road
PH-14	NR	8.27.03	4	NR	Sand (SP)	
PH-15	Lilac Drive	8.28.03	6	NR	Sand (SP)	
PH-16	El Moro Avenue and 11 <sup>th</sup> Street	8.28.03	7	NR	Sand (SP)	
PH-17	13 <sup>th</sup> Street and Santa Ysabel Avenue	8.28.03	6	NR	Sand (SP)	
PH-18	17 <sup>th</sup> Street and Santa Ysabel Avenue	8.28.03	6	NR	Sand (SP)	
PH-19	17 <sup>th</sup> Street and Santa Ysabel Avenue	8.28.03	7	NR	Sand (SP)	
PH-20	10 <sup>th</sup> Street and Santa Ynez Avenue	8.29.03	8	NR	Sand (SP)	
PH-20A	10 <sup>th</sup> Street and Santa Ynez Avenue	8.29.03	10	NR	Sand (SP)	
PH-2A	12 <sup>th</sup> Street	8.29.03	4	NR	Sand (SP)	
PH-21	Pecho Way	9.2.03	9	NR	Sand (SP)	
PH-22	Indio Drive	9.2.03	7	NR	Sand (SP)	
PH-23	Los Osos Valley Road and Pine Ave	9.2.03	8	NR	Sand (SP)	
PH-24	Solano Street	9.2.03	7	NR	Sand (SP)	
PH-25	Los Osos Valley Road and 10 <sup>th</sup> Street	9.2.03	7	NR	Sand (SP)	
PH-26	Los Osos Valley Road and Oakridge Drive	9.2.03	4	NR	Clayey Sand (SC)	
PH-27	Los Osos Valley Road and Willow Drive	9.2.03	4	NR	Clayey SAND (SC)	
PH-28	Los Osos Valley Road and Willow Drive	9.2.03	4	NR	Clayey SAND (SC)	
PH-29	Los Osos Valley Road and Buckskin Drive	9.2.03	5	NR	Clayey SAND (SC)	





No.	Location	Date (mo.da.yr)	AC (inches)	AB (inches)	Subgrade	Other Tests SE = Sand Equivalent R = R-value #200 = fine content
PH-30	Mar Vista Drive	9.2.03	4	NR	Sand (SP)	
PH-31	NR	9.2.03	5	NR	NR	Aggregate Base reported but thickness was NR
PH-32	10 <sup>th</sup> Street and Los Olivos Avenue	9.4.03	8	NR	Sand (SP)	

NR – Not Reported

#### 4.4.1.2 Soil Conditions

**Artificial fill (Af).** Artificial fill materials encountered in our explorations generally consist of soils that appear to be associated with previous grading activities for roadway construction and backfill for existing utilities. The thickness of artificial fill materials is expected to vary in material type and thickness over the study area. Asphalt pavement and aggregate base materials are present over much of the roadway areas, as discussed in the previous section of this report.

The thickest fill materials were encountered in DH-106 drilled on the shoulder of South Bay Boulevard near the East Santa Ysabel Avenue Lift Station, and in DH-114 drilled on the shoulder of Los Osos Valley Road near the Sunny Oak Lift Station. The thickness of the artificial fill encountered in these borings ranged from approximately 14 to 15 feet below the road surface. The existing fill materials generally consisted of medium dense sand and clayey sand with gravel. Where encountered, the artificial fill materials were underlain by dune sand deposits.

Laboratory tests performed on samples of the existing fill had dry densities ranging from approximately 103 to 122 pounds per cubic foot, and moisture contents ranging from approximately 4 to 11 percent. Sieve analysis tests indicate that the artificial fill materials tested had approximately 2 to 24 percent material finer than the U.S. Standard 200 sieve. Atterberg limits tests performed on a sample of clayey sand with gravel (SC) obtained from DH-106 had a liquid limit of approximately 30 percent, and a plasticity index of approximately 10 percent. The sand equivalent for a sample of sand (SP) obtained from the artificial fill materials encountered in DH-114 was 41.

**Dune Sand Deposits (Q<sub>s</sub>).** Dune sand deposits comprise the predominant geologic unit exposed at the ground surface over the collection system area. The areal extent of the dune sand deposits, as mapped by Hall (1973), is indicated on Plate 5a, and is generally consistent with units encountered in the explorations.

The dune sand encountered within the upper 3 to 4 feet of the site was typically weathered with a moderately developed topsoil horizon. The topsoil is typically classified as very loose to medium dense sand (SP), silty sand (SM) and sand with silt (SP-SM). The underlying dune sand typically consisted of loose to very loose fine sand (SP) to depths of



approximately 5 to 10 feet below the ground surface. The sand dune deposits below that depth were typically medium dense to dense sand (SP) and are locally interbedded with zones and lenses of silty sand (SM), clayey sand (SC), sand with silt (SP-SM), and silt (ML).

Within the low lying areas of the site along the Baywood shore, and interdunal depressions such as along Paso Robles Avenue and Ramona Avenue, groundwater was encountered at shallow depths, the dune sand was typically loose and caved into backhoe test pits and drill holes excavated within those areas readily. The dune sand is generally interpreted to overly the age equivalent of Paso Robles Formation over most of the collection system areas. The Paso Robles Formation is a similar sandy material in some areas, and is therefore not always differentiated from the dune sand deposits on the logs of the explorations.

The base of the dune sand, and the contact with the underlying Paso Robles Formation, appears to be relatively uniform and dips to the northwest toward Morro Bay. Within the western portion of the site (west of Palisades Avenue) and near Bayview Heights, the dune sand appears to be a relatively uniform 10- to 15-foot thickness of material blanketing the underlying denser Paso Robles Formation material that is of similar grain size and material type. The underlying contact with the Paso Robles Formation ranges from approximately el. 200 feet north of Highland Avenue to approximately el. -4 feet near the shoreline of Morro Bay.

Within the eastern portion of the site (east of Palisades and north of Los Osos Valley Road), the dune sand is mounded atop of the older Paso Robles Formation, with dune ridges in portions of that rise up to approximately 150 feet above sea level near Santa Maria Avenue. The base of the dune sand contact with the underlying Paso Robles Formation or Estuarine Deposits ranges from approximately el. 115 to 125 feet along Los Osos Valley Road to below sea level along the shorelines of Morro Bay near Baywood, to approximately el. 30 to 40 feet along South Bay Boulevard.

Laboratory tests performed on samples of the sand dune deposits typically had dry densities ranging from approximately 96 to 114 pounds per cubic foot, and moisture contents ranging from approximately 1 to 23 percent. Sieve analysis tests indicate that the samples of the sand dune deposits that were tested had approximately 1 to 17 percent material finer than the U.S. Standard 200 sieve. Sand equivalent test results for samples of sand (SP) and sand with silt (SP-SM) ranged from approximately 34 to 79. Sand equivalent test results for samples classified as silty sand (SM), and sandy silt (ML) were 24 and 20, respectively.

**Estuarine Deposits (Qe).** Estuarine deposit materials were encountered in HA-8 and DH-401, and are generally present within the areal limits of the Morro Bay estuary. HA-8 was drilled on Doris Avenue where the road is constructed across an inlet of Morro Bay. DH-401 was drilled on the north end of 4<sup>th</sup> street along the northern limits of the project and near the southern shoreline of Morro Bay. The surface exposure of the estuarine deposits is mapped as "mud" by Hall (1973), as indicated on Plate 5a.

The estuarine deposits encountered in HA-8 and DH-401 generally consist of organic fat clay (CH), lean clay (CL) with varying amounts of sand and gravel and medium dense sand with





clay (SP-SC) and silty sand (SM). The estuarine deposits were encountered to the maximum depth explored, approximately 5 and 40.5 feet in HA-8 and DH-401, respectively.

**Alluvium (Qal).** Alluvium was encountered in DH-102, DH-110, T-103, CPT-101, CPT-113, CPT-114, CPT-146, CPT 406, CPT 407, CPT-413, and HA 401 and HA 402. The alluvium is generally present along the eastern edge of the Morro Bay estuary and near Baywood. The alluvium is similar in composition to the sand dune deposits, and is therefore difficult to distinguish from the sand dune deposits on the basis of soil classification. Undifferentiated units of alluvium may be present in areas mapped or logged as sand dune deposits, particularly in low lying interdunal depression of the site. The limits of alluvium mapped by Hall (1973) are indicated on Plate 5a.

The alluvium encountered in our borings generally consisted of very loose to dense fine sand (SP, SP-SM) with varying amounts of silt. The deposits are locally interbedded with layers and lenses of gravel, clay, clayey sand and organics. The alluvium was overlain by approximately 9 feet of sand dune deposits in DH-102. The alluvium was encountered to the maximum depth explored, approximately 41 feet below the existing ground surface in DH-110. In CPT-146, performed near the intersection of Mitchell Drive and Pine Street, the alluvium was underlain at a depth of approximately 8 feet by relatively dense sand that may have been units of either older sand dune deposits or the Paso Robles Formation. Similar dense sand units were encountered below the sand dune deposits in this area.

Laboratory tests performed on samples of the alluvium had dry densities ranging from approximately 105 to 118 pounds per cubic foot, and moisture contents ranging from approximately 5 to 20 percent. Sieve analysis tests indicate that samples of the alluvium that were tested had approximately 3 to 5 percent material finer than the U.S. Standard 200 sieve. Sand equivalent test results for samples of sand (SP) ranged from approximately 38 to 77.

**Paso Robles Formation (Q<sub>pr</sub>).** The age-equivalent of the Paso Robles Formation was encountered below the sand dune deposits where they were penetrated, and likely underlies the dune sand over most of the project area. The material locally referred to as Paso Robles Formation may include older wind blown sediment and was commonly of a similar grain size as the overlying dune sand, only denser. The main characteristic that was used to differentiate between what we interpret to be Paso Robles Formation and the sand dune deposits and alluvium, was the relative density of the material encountered, and the presence of clay layers that would not be expected to be encountered within wind blown deposits. The Paso Robles Formation was not observed to outcrop at the site, and therefore is not indicated on Plate 5a.

The Paso Robles Formation encountered in the explorations generally consists of dense to very dense sand (SP), silty sand (SM) and clayey sand (SC). The sand is locally interbedded with 1- to 5-foot thick layers of very hard lean clay (CL). Where encountered in the explorations, the Paso Robles Formation was overlain by approximately 10 to 40 feet of dune sand and/or alluvium. We estimate that up to 100 feet or more of dune overlies the Paso Robles Formation near Santa Maria Avenue.





As discussed previously, the surface of the Paso Robles Formation and contact with the dune sand appears to be relatively uniform and dip to the northwest toward Morro Bay. Within the western portion of the site (west of Palisades Avenue) and near Bayview Heights, the surface of the Paso Robles Formation from approximately elevation 200 feet north of Highland Avenue to approximately el. -4 feet near the shoreline of Morro Bay. Within the eastern portion of the site (east of Palisades and north of Los Osos Valley Road), the surface of the Paso Robles Formation, was encountered from approximately el. 115 to 125 feet along Los Osos Valley Road to below sea level along the shorelines of Morro Bay near Baywood, to approximately el. 30 to 40 feet along South Bay Boulevard.

Laboratory tests performed on samples of the Paso Robles Formation typically had dry densities ranging from approximately 104 to 122 pounds per cubic foot, and moisture contents ranging from approximately 5 to 22 percent.

**Franciscan Rocks (KJf).** Franciscan Rocks are mapped at the ground surface north and east of Los Osos Creek, and were encountered below the Paso Robles Formation in borings by Cleath (2003b). Cleath reported metavolcanic rocks below what appears to be Paso Robles Formation at approximately el. -48 feet in TH-2 drilled at the east end of Santa Ysabel, and at el. -6 feet in TH-4 drilled north of the project site along South Bay Boulevard. The borings were terminated within 5 feet into the bedrock material.

**4.4.2 Pump Stations and Standby Power Buildings**

The pump station areas are generally underlain by surficial sediments consisting of artificial fill, alluvium, sand dune deposits, estuarine deposits, and Paso Robles Formation as previously described in this report for the pipeline areas. Groundwater was commonly encountered within the anticipated depth of excavation for the pump stations, and relatively close to the ground surface in some areas. A general summary of the subsurface conditions encountered in the pump station and standby power building areas is presented below.

**Subsurface Conditions at Pump Station and Standby Power Building Sites**

Structure	Existing Ground Surface El. (ft)	Explorations*	Approximate Depth to Groundwater Encountered and Date Observed (mo.da.yr)**	Subsurface Conditions Encountered
Baywood Pump Station at 2 <sup>nd</sup> Street and El Morro	10	CPT-406	2.5' on 8.6.03	Dune Sand (Qs) and/or Alluvium (Qal): Approximately 15 feet of very loose wet sand (SP) overlying Paso Robles Formation.  Paso Robles Formation (QTp): Very dense sand (SP) with interbedded layers of silty sand (SM).





Structure	Existing Ground Surface El. (ft)	Explorations*	Approximate Depth to Groundwater Encountered and Date Observed (mo.da.yr)**	Subsurface Conditions Encountered
Baywood & Westside Paso Standby Power Building at CSD yard near 8 <sup>th</sup> and El Morro.	25	CPT-405 HA-403	5' on 8.8.03	Dune Sand (Qs): Approximately 15 feet of very loose to dense wet sand (SP) overlying Paso Robles Formation.  Paso Robles Formation (QTp): Very dense sand (SP) with interbedded layers of hard clay (CL).
W. Paso Robles Pump Station at 3 <sup>rd</sup> Street	16	DH-404	8' on 8.12.03	Dune Sand (Qs): Very loose to dense wet sand (SP) and sand with silt (SP-SM). Boring terminated at 34 feet due to sand flowing up into augers.
East Santa Ysabel Avenue Pump Station at South Bay Boulevard	78	DH-106 HA-5	22' on 2.18.97	Dune Sand (Qs): Loose to dense sand (SP) and silty sand (SM). DH-106 terminated in flowing sand.
East Paso Robles Avenue Pump Station at 18 <sup>th</sup>	72	DH-107 CPT-409 HA-2	0' on 1.28.97 8' on 8.8.03	Dune Sand (Qs): Approximately 15 feet of very loose to medium dense wet sand (SP) overlying Paso Robles Formation.  Paso Robles Formation (QTp): Interbedded layers of dense sand (SP), silty sand (SM), and hard clay (CL).
Santa Lucia Pocket Pump Stations (4 <sup>th</sup> to 13 <sup>th</sup> Street)	15' to 76'	DH-401 DH-402 DH-403	13' on 8.11.03 19' on 8.11.03 37' on 8.11.03	Dune Sand (Qs): 3 to 4 feet of loose silty sand (SM) topsoil over medium dense to dense sand (SP). Flowing sand below water table.  Estuarine Deposits: Encountered below Dune Sand in DH-402 at depth of 20 feet (near el. 0 feet). Loose to medium dense Silty sand (SM) and sand with clay (SC-SM) with lenses of lean clay (CL).
Lupine Street Pump Station at Donna Ave.	14	CPT-413 DH-117	5' on 8.17.03 4' on 1.21.97	Dune Sand (Qs): Approximately 15 feet of loose to medium dense sand and sand with silt (SP, SP-SM) overlying Paso Robles Formation.  Paso Robles Formation (QTp): Dense to very dense sand (SP) with interbedded layers of hard clay.
Sunny Oaks Pump Station. Los Osos Valley Road at Sunny Oaks.	153	DH-114	15' on 1.23.97	Dune Sand (Qs): Approximately 35 feet of medium dense sand (SP). Sand flowing into augers.  Paso Robles Formation (QTp): Stiff lean clay (CL) with pockets of sand.
Mountain View Ave. Pump Station at Santa Ynez Ave.	100	DH-406 CPT-135	11' on 1.21.97	Dune Sand (Qs): Approximately 23 feet of loose sand (SP) overlying Paso Robles Formation.  Paso Robles Formation (QTp): Dense sand (SP) with pockets and interbedded layers of very stiff lean clay (CL).





Structure	Existing Ground Surface Et. (ft)	Explorations*	Approximate Depth to Groundwater Encountered and Date Observed (mo.da.yr)**	Subsurface Conditions Encountered
Mountain View Standby Power Building at CSD Yard at Nipomo and S. Bay Boulevard.	107	Dh-405	23' on 8.12.03	Dune Sand (Qs): Approximately 23 feet of loose to dense sand (SP) overlying Paso Robles Formation.  Paso Robles Formation (QTp): Dense to very dense sand (SP) with pockets and interbedded layers of very stiff lean clay (CL).
Pocket Pump Stations at 9 <sup>th</sup> & Ramona, 9 <sup>th</sup> and San Luis, 13 <sup>th</sup> north of San Luis, and 15 <sup>th</sup> north of San Luis/		CPT-411 CPT-412 CPT-404 HA-6	14.5' on 8.7.03 20' on 8.7.03 17' on 8.7.03 8' on 2.18.97	Dune Sand (Qs): Approximately 23 feet of loose sand (SP) overlying Paso Robles Formation.  Paso Robles Formation (QTp): Dense to very dense sand (SP) with interbedded layers of very stiff clay (CL).

\* Other explorations may be near by as shown and referenced on Plate 2a.

\*\* Order of groundwater data is presented in same order as corresponding exploration.

#### 4.4.3 Tri W Wastewater Treatment Plant

The subsurface conditions encountered at the Tri W Wastewater Treatment Plat site generally consist of variable thickness of artificial fill materials (Af), sand dune deposits (Qs), and Paso Robles Formation (Qpr). Subsurface profiles showing the geologic units encountered, depth to groundwater, and field blow count or CPT tip resistance are shown of Plates 7a and 7b, Subsurface Profile A-A' and Subsurface Profile B-B'. A summary of the soil conditions encountered in the explorations is presented below:

**Artificial fill materials (Af).** Artificial fill materials were encountered in five of the CPT explorations (CPT 1 through CPT 5) performed in the roadway areas along the site perimeter. The fill materials appear to be associated with previous site grading and paving for the roadways along Palisades Avenue, Los Osos Valley Road, and Broderson Avenue. The fill materials were encountered from the ground surface down to approximately 1 to 2 feet below the existing ground surface, and consisted asphalt pavement and loose to dense silty sand (SM). The artificial fill materials were underlain by dune sand.

**Dune Sand Deposits (Qs).** Dune sand deposits were encountered at the ground surface or below the artificial fill materials in each of the explorations. The dune sand was encountered to depths of approximately 7 to 17 feet below the existing ground surface, and was underlain by the Paso Robles formation. The dune sand typically consisted of loose to dense fine sand (SP) and sand with silt (SP-SM).

Results of laboratory testing performed on samples of the sand dune deposits had unit weights ranging from approximately 99 to 109 pounds per cubic foot, and moisture contents ranging from approximately 2 to 5 percent. Samples of the dune sand that were tested typically had approximately 1 percent fines (particles smaller than 0.075 mm).





**Paso Robles Formation ( $Q_{pr}$ ).** Paso Robles Formation was encountered below the dune sand deposits in each of the explorations, and is exposed in drainages that run through the site. The Paso Robles formation consists of interbedded layers of medium dense to very dense sand (SP), sand with silt (SP-SM), sand with clay (SP-SC), silty sand (SM), silty clayey sand (SC-SM), clayey sand (SC), and stiff to hard lean clay (CL), fat clay (CH), sandy silt (ML), and silt (ML). Occasional gravel was also encountered at the various depths within the Paso Robles formation and is noted in the logs. The Paso Robles Formation was encountered to the maximum depth of each of the explorations, approximately 25 to 71 feet below the existing ground surface.

Results of laboratory testing on samples of the Paso Robles formation had total unit weights ranging from approximately 112 to 131 pounds per cubic foot, and moisture contents ranging from 5 to 28 percent.

#### **4.4.4 Effluent Disposal Sites**

The following summarizes the subsurface conditions encountered in the primary disposal site areas. The deferred disposal site areas are located at various locations within the collection system network. The soil conditions for the collection system area were previously described in this report.

##### **4.4.4.1 Broderson Site**

A summary of the subsurface conditions encountered at the Broderson Effluent Disposal and prototype percolation site is prepared and summarized on the Subsurface Profile C-C' presented on Plate 7c. Additional boring and CPT logs from the Metcalf & Eddy (1996a) and Fugro (1996a) are presented in Attachment A. The soil conditions generally consist of a relatively uniform thickness of dune sand overlying the age-equivalent of the Paso Robles Formation. The results of the percolation and prototype testing were previously described in this report.

**Dune Sand Deposits ( $Q_s$ ).** Dune sand deposits were encountered at the ground surface in each of the explorations. The dune sand was encountered to depths of approximately 10 to 35 feet below the existing ground surface, and is underlain by the Paso Robles Formation. The dune sand typically consisted of loose to medium dense fine sand (SP) and sand with silt (SP-SM). The dune sand is locally interbedded with lenses of silt (ML), clay (CL), and clayey sand (SC).

Results of laboratory testing performed on samples of the dune sand deposits typically had dry unit weights ranging from approximately 94 to 105 pounds per cubic foot, and moisture contents ranging from approximately 2 to 12 percent. The fines content (particles smaller than 0.075 mm) of the sand samples that were tested typically ranged from approximately 1 to 9 percent.

**Paso Robles Formation ( $Q_{pr}$ ).** The age-equivalent of the Paso Robles Formation was encountered below the dune sand deposits where they were penetrated, and likely underlies the



dune sand over the project area. The material locally referred to as Paso Robles Formation may include older wind blown sediment and was commonly of a similar grain size as the overlying dune sand, only denser. The main characteristic that was used to differentiate between what we interpret to be Paso Robles Formation and the sand dune deposits and alluvium, was the relative density of the material encountered, and the presence of clay layers that would not be expected to be encountered within wind blown deposits.

The Paso Robles Formation encountered in the borings generally consists of dense to very dense sand (SP), silty sand (SM), and clayey sand (SC) with varying amounts of silt. The sand is locally interbedded with 1- to 2-foot thick layers of very hard lean clay, and zones of silty sand and sand with silt. Where encountered in the borings and CPT soundings, the Paso Robles Formation was overlain by approximately 15 to 35 feet of sand dune deposits. The Paso Robles Formation was encountered to the maximum depths explored at the site, approximately 165 feet below the existing ground surface in M&E (1995) boring B-8.

Results of laboratory testing performed on samples of the Paso Robles Formation obtained from the borings had dry densities ranging from approximately 104 to 110 pounds per cubic foot, and moisture contents ranging from approximately 3 to 9 percent. Sieve analysis tests indicate that a sample of the Paso Robles Formation had approximately 1 percent material finer than the U.S. Standard 200 sieve.

#### **4.4.4.2 Santa Maria Avenue Site**

A summary of the subsurface conditions encountered at the Santa Maria Effluent Disposal and prototype drywell site is summarized on the Subsurface Profile D-D' presented on Plate 7d. Additional boring information in this vicinity is presented on the Cleath (2003b) logs. The soil conditions generally consist of a relatively deep dune sand overlying Paso Robles Formation. The results of the percolation and prototype testing were previously described in this report.

**Dune Sand Deposits ( $Q_5$ ).** The Santa Maria disposal site is located near el. 120 feet on the north-facing slope of the highest dune ridge within the Los Osos area. Dune sand deposits were encountered at the ground surface in each of the explorations to the maximum depth explored, approximately 51 feet below the existing ground surface. The dune sand was underlain by the Paso Robles Formation where encountered in a Cleath (2003b) borings (see Plate 7d) at approximately 60 feet below the existing ground surface (el. 35 feet). The dune sand encountered consisted medium dense to very dense fine sand (SP). The dune sand is locally interbedded with lenses and pockets of silty sand (SM) and silt (ML).

Results of laboratory testing performed on samples of the dune sand deposits typically had dry unit weights ranging from approximately 102 to 108 pounds per cubic foot, and moisture contents ranging from approximately 3 to 6 percent. The fines content (particles smaller than 0.075 mm) of the sand samples that were tested typically ranged from approximately 2 to 3 percent.



#### **4.4.4.3 Pismo Avenue Site**

CPT 120 to 122, and CPT 408 and CPT 410 were performed along Pismo Avenue within the planned effluent disposal system area. The soil conditions generally consist of a relatively deep dune sand overlying Paso Robles Formation. The results of the percolation and prototype testing were previously described in this report.

The CPT encountered relatively deep dune sand deposits similar to those described for the Santa Maria site. The dune sand typically consisted of loose to very dense sand encountered to depths of The dune sand was encountered to a depth of approximately 28 feet in CPT408 advanced near 10<sup>th</sup> Street, and to approximately 35 feet in CPT 410 advanced near 16<sup>th</sup> street. The dune sand appeared to be underlain by similar but denser units of sandy Paso Robles Formation. The Paso Robles Formation was interbedded with 1 to 2 foot layers of dense or cemented sand and lenses of clay at various depths. The Paso Robles Formation was encountered to the maximum depth explored, approximately 50 feet below the existing ground surface.

### **4.5 GROUNDWATER CONDITIONS**

Shallow groundwater is common over much of the project area. Groundwater was encountered in various CPT soundings, drill holes, and backhoe pits performed within the project area. The depth to groundwater was observed in the borings and interpreted from CPT data as the depth at which pore water pressures were first recorded with the cone penetrometer's piezo-element, and from CPT piezocone dissipation tests. The depth to groundwater encountered in these explorations ranged from approximately 1 foot to greater than 80 feet below the ground surface. We also observed that there were numerous springs and areas of ponded water at the site. Additional groundwater data was also obtained from Cleath and Associates for various monitoring wells that have been installed at the site by the County of San Luis Obispo.

The groundwater levels were estimated from the various data sources to estimate to "first water" as encountered in the explorations and estimate from the County data. We then used our geographic information system to analyze and plot these data, as summarized on Plates 8a, 8b and 8c. The groundwater conditions are relatively complex, particularly within the southeast quadrant of the site, as a result of the presence of shallow clay layers that result in perched groundwater conditions. Groundwater conditions appear to vary seasonally, and fluctuate as much as 5 to 10 feet in some areas.

Plate 8a presents estimated 1990-groundwater surface contours estimated from the County well data. The County wells commonly penetrate shallow zones of perched water that were encountered in our explorations, and may represent a deeper water table in some areas or conditions when the perched groundwater is not present during drought years.

Plate 8b presents the estimated "first water" contours encountered in our exploration and from County well data for explorations performed during the period of 1995 to 2003. Using Fugro's GIS database, these data were then used to calculate the difference between the



ground surface topography provided by MWH and the groundwater surface contours presented on Plate 8b. The results are summarized on Plate 8c, which is the estimated depth to first groundwater encountered during the period of 1995 to 2003.

The groundwater contour elevations are approximately and were interpolated between points of observation. County well data typically has groundwater level 5 to 10 feet higher in 1998 than in 1990, and in some case more than 20 feet. Groundwater and soil moisture conditions will fluctuate seasonally, and as a result of changes in precipitation, storm runoff, irrigation schedules and other factors. The groundwater conditions in areas near Morro Bay appear to be influenced by tidal changes, such as was observed in the area of HA-8 drilled on Doris Avenue just south of its intersection with Lupine Street.





## **5. GEOLOGIC HAZARDS ASSESSMENT**

### **5.1 FAULT RUPTURE**

The Irish Hills segment of the Los Osos fault is the closest mapped fault to the site, and is mapped approximately 1,500 feet south of the project area at its closest point. There is a low potential for fault rupture to impact the project site.

### **5.2 STRONG GROUND MOTIONS**

The Los Osos area is located in a seismically active region of central California relatively close to mapped active and potentially active faults. The closest fault zoned active by the CGS is the Los Osos fault located approximately 1 mile south of the project area, which is considered capable of a maximum earthquake of M6.8.

Peak horizontal ground accelerations for the site were estimated using probabilistic seismic hazard analyses. Based on the probabilistic seismic hazard analysis, we estimate that strong ground motion having 10 percent probability of being exceeded during a 50-year and 100-year period is approximately 0.37g and 0.50g, respectively.

### **5.3 LANDSLIDES AND SLOPE STABILITY**

To our knowledge the site is not within an area of mapped landslides, or of known slope instability. The project site is located on relatively flat to moderately sloping terrain. It is our opinion that there is a low potential for landslides to impact the project as presently planned. Slope stability analyses were performed to provide a basis for providing the recommended geosynthetic reinforcement and spacing needed for retaining wall design, and presented in this report.

#### **5.3.1 Slope Stability Evaluation for Reinforced Retaining Walls**

Slope stability analyses were performed on generalized cross-sections for the segmental masonry unit (SMU) retaining wall to be located at the treatment plant facility and for the boulder-covered slopes proposed for the sedimentation basin. The purpose of our slope stability analyses was to provide a basis for recommending geosynthetic reinforcement for the design of retaining walls and slopes presented in this report. The proposed wall and slope conditions were evaluated with respect to the slope stability criteria discussed below. The main output from the slope stability analyses is presented in Appendix C.

##### **5.3.1.1 Slope Stability Criteria**

Typical slope stability criteria are described in the California Division of Mines and Geology (1997) *Guidelines for Evaluating and Mitigating Seismic Hazards in California*. In this study, for the purpose of evaluating the analytical results, the wall and slope were considered stable when the estimated factor of safety was at least 1.5 under static loading conditions, and at least 1.1 under pseudostatic (earthquake) loading conditions when using a horizontal





pseudostatic coefficient of 0.15. A factor of safety of 1.0 represents the theoretical boundary below which a slope is no longer stable and experiences failure. However, factors of safety greater than 1.0, such as those stated above, are typically used to define stable slope conditions in practice to help account for uncertainties associated with characterizing subsurface conditions and limitations associated with the geotechnical analyses used to evaluate slope stability.

### **5.3.1.2 Approach**

**Analysis Methods.** The slope stability analyses were performed using the computer program STEDwin (Van Alier 1999). STEDwin was used with PCSTABL to estimate factors of safety for slope stability under static and pseudostatic loading conditions. STEDwin requires the user to define the surface and subsurface profile boundaries; soil properties including unit weight ( $\gamma$ ), friction angle ( $\phi$ ) and cohesion ( $c$ ); groundwater levels; and the analysis method to be used. The soil properties and conditions used for these analyses are presented in Appendix C. Slope stability analyses were performed using the modified Bishop method to estimate factors of safety for circular failure surfaces.

The SMU retaining wall and boulder-covered slope configurations evaluated as part of the slope stability analyses were based on drainage and grading plans and typical sections provided by MWH (2003b). The facing units of the SMU retaining wall were assumed to be 8 inches high and 18 inches deep. We varied the location, length, vertical spacing, and long term design strength (LTDS) of the geosynthetic reinforcing layers as part of our stability evaluations for the wall and slope.

**Selection of Shear Strength Parameters.** Strength parameters ( $\phi$  and  $c$ ) for backfill and foundation materials were selected for slope stability analyses based on the results of laboratory direct shear test performed on remolded samples of potential borrow and on driven ring soil samples obtained from the field exploration program. Strength parameters for the SMU retaining wall blocks were selected based on available product information and our experience on similar projects. The strength parameters used for our slope stability analyses are presented on the plotted output in Appendix C.

**Groundwater Considerations.** Groundwater and areas of wet soil were encountered in our explorations as discussed in this report. Factors of safety for the SMU retaining wall were estimated assuming existing groundwater levels are below the anticipated depth of excavation, as encountered in our field explorations. In evaluating factors of safety for the slopes of the sedimentation basin, we assumed a water level elevation of 87 feet.

### **5.3.1.3 Summary of Slope Stability Results**

Selected output from the slope stability analyses are presented in Appendix C. The analyses for static and pseudostatic loading conditions are presented for maximum sections associated with the SMU retaining wall and the sedimentation basin boulder-covered slope. A discussion of the results is presented below.





**SMU Retaining Wall.** Slope stability analyses were performed for the tallest section of the SMU retaining wall assuming a wall height (H) of 23 feet and a wall batter of 8v:1h. The embedment depth at the base of the wall was assumed to be 3 feet, resulting in a total wall height of 26 feet. We varied the location, length, vertical spacing, and LTDS of the geosynthetic reinforcing layers behind the retaining wall in evaluating slope stability to provide the minimum factors of safety needed for slope stability: 1.5 for static loading conditions and 1.1 for pseudostatic loading conditions. Factors of safety were estimated assuming 18-foot long geosynthetic reinforcing layers (LTDS = 5000 pounds per foot) spaced at 4 feet vertically. The first reinforcing layer was located at the same elevation as finish grade in front of the wall.

Slope stability analyses were performed for additional retaining wall sections with smaller face heights in order to design the appropriate geosynthetic reinforcing. We used the results of these analyses to develop the design recommendations included in this report. A summary of our stability analyses for the SMU retaining wall is provided in the table below.

**Summary of Slope Stability Analyses for the SMU Retaining Wall**

Wall Face Height, H (ft)	Geosynthetic Reinforcing Length, L (ft)	Estimated Factor of Safety: Static Condition	Estimated Factor of Safety: Pseudostatic Condition
23	18	1.5	1.2
19	12	1.5	1.2
15	9	1.6	1.1
11	8	1.5	1.1

\* - Geosynthetic reinforcing assumed to have vertical spacing of 4 feet and LTDS of 5,000 pounds per foot.

**Sedimentation Basin Slopes.** We performed slope stability analyses for a typical section of the sedimentation basin slope assuming a slope height of 8 feet and a slope inclination of 1v:1½h. Above a height of 8 feet, we assumed the ground would be graded to an inclination of 1v:6h. We varied the location, length, vertical spacing, and LTDS of the geosynthetic reinforcing layers within the slope in evaluating slope stability. The first reinforcing layer was located at the same elevation as finish grade in front of the slope. We assumed that the geosynthetic reinforcing layers were wrapped at the slope face. In addition, we neglected the stabilizing influence of the boulder facing by not including the boulders in our analyses.

Factors of safety equal to approximately 1.6 and 1.2 for static and pseudostatic loading conditions, respectively, were estimated for 11-foot long geosynthetic reinforcing layers (LTDS = 1,000 pounds per foot) spaced at 2 feet vertically. The groundwater levels were assumed to be 87 feet and 65 feet for the static and pseudostatic evaluations, respectively.





#### **5.4 GROUND LURCHING**

Ground lurching occurs as the ground is accelerated during a seismic event. As evidenced by the Loma Prieta, Landers, and recent Northridge earthquakes, the effects of ground lurching can damage buried pipelines. Ground lurching occurs due to decollement or detachment of underlying stratigraphic units, allowing near surface soils to move differentially from underlying soils and from localized amplification and damping of seismic waves due to "basin effects". Because the project area is in a historically seismic area and has variable foundation soil conditions, the potential exists for ground lurching to affect the proposed project; however, to the best of our knowledge, we know of no method to evaluate the location or magnitude of potential ground lurching in the project area.

#### **5.5 EXPANSIVE SOIL**

Expansive soil generally consists of fine-grained soil of high plasticity (clay) that can damage near-surface improvements in response to swelling associated with increased moisture content. The near surface soil conditions encountered at the site predominantly consist of granular materials. It is our opinion that these soils have a low to very low potential for expansion (Expansion Index less than 20) on the basis of classification provided in the Uniform Building Code.

#### **5.6 TSUNAMIS AND SEICHES**

Tsunamis, or long-period sea waves created due to seismic events or submarine landslides, have historically occurred in the project region. Tsunamis can range in height from a few feet to greater than 50 feet (a recent earthquake off of Hokkaido Japan resulted in a tsunami greater than 100 feet in height), and can result in run-ups, or bores, extending great distances up streams, rivers, and creeks. The site is located at an elevation ranging from approximately sea level for the portions of the pipeline that bound Morro Bay, to approximately el. 80 feet above mean sea level (MSL) at the treatment plant site, to approximately el. 200 feet above MSL at the Broderson effluent disposal site. Because the sand spit separates the western edge of Morro Bay from the Pacific Ocean, the project area is not directly exposed to wave attack from the open sea. It is our opinion that the greatest potential for tsunamis to impact the site comes from inundation due to wave run up that could temporarily impact water levels in the bay.

According to Kilbourne and Muaichin (1980), the following historical tsunamis have occurred in the project region:







### Historical Tsunami Run-up

Year	Estimated Tsunami Generation Location	Estimated Impact Location	Estimated Tsunami Run-up (meters/feet)
1868 <sup>1</sup>	Unknown	Morro Bay	Unknown
1878 <sup>2</sup>	Unknown	Morro Bay	Unknown
1927	Local	Pismo Beach	1.8 meters/5.9 feet
1946	Aleutian Trench	San Luis Obispo Bay	1.2 - 1.5 meters/3.9 - 4.9 feet
1960	Chile-Peru Trench	Central Coast	>1.0 meters/>3.3 feet
1964	Gulf of Alaska	Central Coast	>1.0 meters/>3.3 feet
<sup>1</sup> Speculative			
<sup>2</sup> Reportedly overtopped the sand spit that separates the bay from the ocean (SLO County 1999).			

As noted in the above table, tsunamis generated from far-field sources have historically occurred in the project region. A study performed by Houston and Garcia (1978) estimated the 100-year and 500-year tsunami runups in the study area based upon far-field source generation locations (such as the Aleutian or Chile-Peru Trenches). On the basis of their study, the estimated tsunami runup along the Cayucos/Morro Bay coastline is up to approximately 9.5 feet to 24.2 feet for the 100-year and 500-year events, respectively. Those runups were calculated using astronomical high tides, and compare well with recorded tsunamis that have occurred in Crescent City and other locations along the California coast. However, according to Kilbourne and Mualchin, the worst case scenario would occur if a tsunami occurred during a meteorological high tide (storm surge), which would add an estimated 15 feet to the runup values calculated by Houston and Garcia (1978). Thus, with a worst case scenario, the estimated tsunami runup for the 100-year and 500-year would be approximately 25 and 40 feet, respectively.

Houston and Garcia's (1978) study did not evaluate the tsunami runup potential generated from local seismic events or local submarine landslides. It is difficult to model the tsunami runup magnitudes based on local events; however, it is thought that local events can generate tsunamis of equal magnitudes as far-field tsunami sources (Kilbourne and Mualchin 1980).

Some areas of the pipeline are below the estimated tsunami runup elevations for the 10-year and 500-year event. Tsunami runups should not result in adverse impacts to the pipeline in areas where it is buried and protected from scour, or impact areas where the pipeline is above the runup elevations. We would expect that there is a potential that locally the pipeline could be exposed and possibly damaged as a result of erosion associated with tsunami runup.

### 5.7 SOIL EROSION

The surface soils encountered at the site consist predominantly of granular sand dune deposits and alluvium that are generally susceptible to erosion. Erosion can occur as gullying in areas of concentrated flows of runoff, or as rilling or mass wasting of slopes that are not





protected by vegetation. Soil erosion is apparent in many areas of the project site, including areas in and directly adjacent to the proposed Tri W site. Project improvements, and erosion maintenance plans, can be designed to reduce the potential for soil erosion.





## 5.8 LIQUEFACTION AND SEISMIC SETTLEMENT

We evaluated the potential for liquefaction and seismic settlement to impact the various components of the project. For the purpose of our evaluation we considered the design basis ground motion of approximately 0.4g, and a corresponding earthquake magnitude of 6.8. The analysis was performed using procedures described in the 1997 NCEER guidelines for performing liquefaction analyses using CPT data. Seismic settlements were calculated in association with the liquefaction analyses; however, seismic settlement can also occur in non-liquefiable soil. Field data from the current supplemental field exploration and previous CPT soundings were obtained electronically using an onboard-computerized data acquisition system. These data were then imported into a geographic information system (GIS) to configure the digital information, and analyze liquefaction potential using a programmed algorithm.

The results of the analyses are presented in Appendix D for various CPT data as a plot of the CPT tip resistance, the calculated CPT resistance needed to resist liquefaction, and the sleeve friction. The cumulative volumetric strain/seismic settlement potential calculated from the data is also presented on the plots. The red line on the plots is the estimated CPT tip resistance that is needed to resist liquefaction for the seismic conditions considered. A blue zone between the red line and the CPT tip resistance indicates a zone of potentially liquefiable soil. Seismic settlement is discussed in the subsequent section of this report.

Liquefaction is a loss of soil strength due to a rapid increase in soil pore water pressures due to cyclic loading during a seismic event. In order for liquefaction to occur, three general geotechnical characteristics are typically present: 1) groundwater is present within the liquefiable zone; 2) the soil is granular; and 3) the soil is in a low to medium state of relative density. If those criteria are met and those soils are subjected to strong ground motions, then those soils may liquefy, depending upon the intensity and cyclic nature of the strong ground motion. Seismically induced settlement or collapse can occur in soils that are loose, soft, or that are moderately dense and weakly cemented, or in association with liquefaction.

Manifestations of liquefaction can consist of sand boils, loss of bearing capacity, lateral spreads and slope instability, and differential and areal settlement. The severity of the consequences of liquefaction is dependent on relative density of the soil and intensity and duration of the ground motions; however, not all soils that liquefy experience the same degree mobility or ground failure. For the purposes of this report, we evaluated the potential for soils to liquefy based on the previous data available and the supplemental field exploration.

### 5.8.1 San Simeon Earthquake

We reviewed selected areas of the project site on the afternoon following the December 22, 2003 magnitude 6.5 San Simeon Earthquake to observe whether or not there was evidence of liquefaction or other earthquake damage. The epicenter of the earthquake was located approximately 25 miles north of the site, and is estimated to have resulted in a ground acceleration of 0.18g in the project vicinity (U.S. Geologic Survey 2004). We visited the low-lying areas of the collection system, Tri-W site, and pump station locations.





Evidence of liquefaction appeared to occur along the shorelines of Morro Bay and Cuesta Inlet. Liquefaction was manifested as sand ejecting around the pilings that support the Baywood T-pier, numerous sand boils and mud volcanoes on the shore of Morro Bay mainly below the high-tide line, and lateral spreads, pipes, and fissures along the shoreline of Cuesta Inlet. The liquefaction appeared to be constrained to near the shoreline, and did not visually appear to have seriously impacted the adjacent roadways or infrastructure such as may have been evidenced by cracks, fissures, or differential settlement.

The liquefaction appears to have occurred within a relatively shallow layer of loose sand that was encountered in various explorations. An example is CPT-406, advanced near 2<sup>nd</sup> and El Morro in Baywood, near the T-pier. Loose sandy materials encountered to depths of approximately 7 feet below the existing ground surface are estimated to be liquefiable as shown on CPT-406 in Appendix D, Plate D-6. The depth of the potentially liquefiable materials indicated by the blue zone on Plate D-6, corresponds to the elevation where sand boils and mud volcanoes were observed along the shoreline near and beyond the T-pier. It is this general depth of loose sand soil that is commonly observed in the explorations, and has the greatest potential for liquefaction. We did not observe evidence of liquefaction or differential seismic settlement at the higher elevations of the project such as at the Tri-W, Broderson, effluent disposal sites, nor at the pump station sites that are typically located away from the shoreline.

The manifestation and damage that can be associated with liquefaction is strongly dependent on the duration of the ground motion. Larger magnitude earthquakes typically result in longer periods of shaking. Earthquakes that occur closer to a site generally result in higher ground motions than a similar magnitude earthquake that could occur away from the site. The design basis earthquake is of similar magnitude to the San Simeon Earthquake (M6.8 vs. M6.5) and has higher ground motion (0.4g vs. 0.18g).

### 5.8.2 Pipeline Network

Liquefaction can result in ground mobility that impacts pipeline grades, or results in pipelines floating out of the ground in areas of liquefaction. The collection system will consist of approximately 40 miles of pipeline that will essentially be constructed over the Los Osos, Cuesta-by-the-Sea and Baywood communities. The soils encountered within the pipeline network vary from soils having a relatively high potential for liquefaction, to soils having a relatively low potential for liquefaction. The potentially liquefiable soils were typically encountered in areas that are either low in elevation or relative topographic relief, such as the shoreline areas along Morro Bay and interdunal depressions along Morro Avenue, Paso Robles Avenue, Santa Ynez Avenue, and Ramona Avenue-Mitchell Drive. These areas are typically characterized as being underlain by relatively loose sand and shallow groundwater. The potentially liquefiable sand is typically less than 10 feet thick.

The estimated seismic settlement that could occur during the design basis earthquake is estimated to be approximately 1 inch, with a range of negligible settlement to about 1-1/2 inches of settlement. Loose sand blankets the upper 5 to 10 feet of the site over most of the collection system area. Soils having a low potential for liquefaction were generally encountered in the higher elevations of the site, such as the predominant dune ridges along Pismo Avenue, eastern





Santa Maria-El Morro Avenue, and in the Broderson-Skyline Avenue area. These areas are typically characterized as being underlain by relatively dense sand, and/or areas where groundwater is deep relative to the planned depth of the pipe.

### **5.8.3 Pump Stations and Standby Power Buildings**

The pump stations and standby power buildings are generally located in areas of relatively low relief, and commonly in areas of relatively shallow groundwater. As discussed in the previous section of this report, these low-lying sites (although necessary for collection) are the most vulnerable to liquefaction and seismic settlement. CPT logs 403-407, 409, and 411-413 in Appendix D present the liquefaction analyses for various pump station and pocket pump station areas. The locations of the soundings are shown on Plates 2a. The liquefaction potential at the pump station sites is mainly dependent on the relative density of the sand, the groundwater elevation, and whether or not potentially liquefiable dune sand near the ground surface can be removed relatively easily during the site grading. We estimate that the soil within approximately 5 to 7 feet of the ground surface in selected pump station and power building areas is susceptible to seismic settlement and liquefaction. We have provided grading recommendations in the report to remove the more loose and potentially liquefiable soil within the pump station areas, and thereby reduce the potential for seismic settlement and liquefaction to impact the structures.

The wet wells and vaults for the pump station are located below the depth of the loose sand encountered. The recommended grading should help to limit differential settlement between the deeper vaults and wet wells, and the adjacent buildings. We estimate that without grading the foundation support soil for the planned buildings could be vulnerable to 1 to 2 inches of seismic settlement, and a loss of foundation support that could result in additional settlement of the structures. The grading recommendations of this report are intended to limit seismic settlement to less than 1 inch below the structures, and maintain foundation support for the structure during the design basis earthquake.

### **5.8.4 Tri-W Treatment Plant Site**

The Tri-W site is underlain by a variable thickness of relatively loose to medium dense sand dune deposits that overlie relative dense sand of the Paso Robles Formation (age-equivalent). The groundwater table was generally encountered within the denser sand and below the base of the dune sand deposits. The denser sand within the Paso Robles Formation is estimated to have a relatively low potential for seismic settlement and liquefaction. According to the recommendations of this report, the overlying loose dune sand should be removed from the planned building and plant equipment areas as part of the construction and be replaced with compacted fill having a low potential for liquefaction and seismic settlement.



## 5.8.5 Effluent Disposal Systems

### 5.8.5.1 Broderson Site

The effluent disposal system at Broderson will be located on a relatively gently sloping hillside approximately 1,200 feet south of Highland Avenue. Approximately 800,000 gallons per day of treated effluent will be disposed of at this site using a buried percolation line trench system. The existing depth to groundwater is greater than 100 feet below the existing ground surface, and except for the near-surface loose dune sand deposits the deeper soils encountered beneath the site are generally dense and not susceptible to liquefaction or seismic settlement. The near-surface loose dune would be considered potentially liquefiable in the event that they were saturated at the time of an earthquake; however, the groundwater depths will not be permitted to rise within 20 feet of the ground surface at the site. The results of the liquefaction analyses performed for the Broderson site are summarized on CPT logs CPT-01 through CPT-17 in Appendix D.

The hydrogeologic conditions and estimated mounding of the groundwater table associated with the disposal of effluent at the site is characterized by Cleath and Associates (2000). At the Broderson site, the mounding should not result in the groundwater level being any closer than 20 feet below the ground surface immediately below the percolation trenches. The upper perched mounding occurs on a layer referred to as Horizon A, and off-site the perched mounding pinches just north of Highland Avenue. The mounding on the lower water surface is estimated to rise within approximately 40 to 50 feet of the existing ground surface within the offsite area between Highland Avenue and Los Osos Valley Road. North of LOVR the mounding is estimated to be within approximately 10 feet or less of the existing groundwater level. For the purpose of our evaluation, we assumed a groundwater depth of 20 feet below the existing ground surface, except where groundwater was encountered shallower than 20 feet in the Cuesta-by-Sea vicinity near Morro Bay. Harvest wells will be used to limit mounding in areas where the groundwater is already relatively shallow north of Los Osos Valley Road.

CPT explorations were advanced to depths of approximately 60 feet below the existing ground surface at and in the vicinity of the Broderson site. Metcalf & Eddy (1995) advanced borings with standard penetration testing (SPT) to depths of up to approximately 160 feet below the existing ground surface. The CPT and SPT resistance indicate that the soils encountered below the dune sand to the existing groundwater table is predominately dense to very dense sand. Dense to very dense sand materials are generally not vulnerable to liquefaction or seismic settlement as a result of their relatively high state of density. There is therefore a low potential for liquefaction to occur within the anticipated depths of mounding.

Previous studies by Fugro (1996), CFS (2000b), and Cleath and Associates (2000) discussed the potential for liquefaction to occur in association with the effluent disposal at Broderson. The main differences between the current and previous evaluations are summarized as follows:

- ❖ Fugro (1996) was a preliminary study based on older CPT procedures that identified general soil types (loose to medium dense sand) that may be vulnerable to



liquefaction. The study identified that relatively thin and discontinuous finer grained soil units and sand at various depths as potentially liquefiable in the event that they were saturated at the time of an earthquake. These layers were further analyzed using the more current NCEER (1997) procedures as part of the current study. The current analyses indicate that the soils have a low potential for liquefaction based on updated CPT procedures that include corrections for material type.

- ❖ CFS (2000b) studies were preliminary studies based on conservatively comparing the CPT resistance needed to resist liquefaction in clean sands to equivalent SPT blow-counts estimated from the CPT data. This study was limited and not intended to serve as a final analysis or assessment of liquefaction, but to provide a general comparison that the project could have on liquefaction potential relative to existing conditions. CFS (2000b) preliminarily estimated that there was a potential for liquefaction to occur within a discontinuous layer of finer-grained material encountered at 25 feet or more in various CPT soundings. The current analyses performed for this study were based on NCEER (1997) methods for CPT analyses. Similar results were obtained for dense clean sandy materials analyzed by CFS. Further analysis of the finer grained soil that were not specifically analyzed by CFS indicate the fine grained soil units also have a low potential for liquefaction.
- ❖ Cleath and Associates (2000) estimated the depth of mounding due to effluent disposal at Broderson and concluded that there was a potential for liquefaction to occur at Broderson and offsite based on the previous preliminary studies. As discussed above, there is a low potential for liquefaction to occur at the site or within the offsite areas downslope of Broderson as a result of the effluent disposal. There is essentially no change in the potential for liquefaction or seismic settlement to occur within the soils encountered as a result of the effluent disposal system and estimated mounding at Broderson.

#### **5.8.5.2 Pismo and Santa Maria Sites**

The Pismo and Santa Maria sites are located on dune ridges along Pismo Avenue and Santa Maria Avenue, respectively (see Plates 2a). The results of the liquefaction analyses performed for the Santa Maria site are summarized on CPT logs CPT-401 through CPT-403 in Appendix D. The results of the liquefaction analyses performed for the Pismo site are summarized on CPT logs CPT-408 and CPT-410 in Appendix D. The soils encountered at these sites are relatively dense dune sand that has a low potential for liquefaction to depth of greater than 50 feet below the existing ground surface.

Relatively loose soil deposits and high groundwater conditions currently exist in the low-lying interdunal areas. As discussed for the pipeline network, these interdunal low-lying areas have a potential for liquefaction and seismic settlement in response to earthquake loading based on existing subsurface conditions and design basis earthquake. The dune ridges are underlain by dense soil and have a low potential for liquefaction. As the groundwater levels will be similar to existing conditions in the interdunal areas following construction, there is no net change in liquefaction potential expected.





## 6. CONCLUSIONS AND RECOMMENDATIONS

The conclusions and recommendations of this report are based on the results of our exploration and testing programs, and on our understanding of the project. We have provided the following opinions and recommendations for the design of the collection systems, pump and lift stations, effluent disposal system, and wastewater treatment plant.

### 6.1 SUMMARY OF FINDINGS

- ❖ The soil conditions encountered predominantly consist of loose to medium dense dune sand overlying denser sand with interbedded silty sand and clay of the Paso Robles Formation. Alluvium and estuarine deposits were encountered in some areas of the site near Morro Bay. Groundwater depths range from at or near the ground surface, to having not been encountered to depths in excess of 80 feet.
- ❖ Portions of the sand dune deposits, when placed according to the recommendations of this report are considered suitable for pipe bedding, pipe zone and trench backfill material.
- ❖ High groundwater conditions will likely require that portions of the pipeline trench be dewatered, and the trench subgrade be stabilized with gravel to allow for excavation and placement of the pipe and backfill materials. Dewatering in shallow groundwater areas should be performed in advance of the trench excavation, or be performed in association with continuous tight shoring systems (such as sheet piles) to maintain stable slope and subgrade conditions during excavation.
- ❖ The dune sand and alluvium consist of loose granular soil; mostly sand (SP, SM). The sandy soils will not stand vertically, nor should be considered stable when cut vertically. Temporary construction slopes will need to be either flattened to a stable slope inclination or shored to allow for the pipeline construction.
- ❖ "Dragging a shield" is a common method of providing worker safety during trenching and pipe construction. However, unless specific provisions to emplace the shield tight against the sidewalls, a shield provides no support for the trench sidewalls and should not be considered a shoring system. Relatively deep trenching will be needed to construct the sewer collection system pipeline. Even moderate caving in deep trenches can result in cracking of adjacent pavement to several feet or more beyond the sawcut line. The contractor will likely need to provide continuous metal, plywood, or timber, sheeting, or jackable shields, to support vertical trench walls, and avoid damage to adjacent structures, utilities, and pavement. Trench walls lacking adequate support could experience trench wall instability or movements that could damage adjacent pavements, utilities, or structures.
- ❖ Site preparation for the treatment plant should consist of removing loose dune sand materials from foundation areas, and replacing those materials as compacted fill. Relatively deep, up to 10-foot, excavations could be needed to remove the loose material from the planned building areas.







- ❖ The treatment plant facilities can be supported on shallow foundation systems bearing in the compacted fill. Buried portions of the structure should be designed to resist lateral earth pressures.
- ❖ Pump stations will likely be installed in sandy soil conditions below the groundwater table. Dewatering or wet construction techniques will be needed to allow for the pump station construction. Installation methods can likely consist of shoring and dewatering a temporary excavation around the pump station wells, or sinking the wells using caisson type construction. Caisson type construction typically consists of excavating soil from the center of the well allowing its outer casing to sink into the ground. A seal course is then placed in the base of the excavation to resist buoyancy forces associated with high groundwater conditions prior to dewatering.
- ❖ The effluent disposal system can consist of percolation lines and drywells as planned. The planned effluent disposal sites are underlain by relatively well-drain dune sand deposits. Prototype testing was performed at the site as basis of recommending suitable application rates for the design of the effluent disposal system.
- ❖ The site is in a seismically active area of California. The plant should be designed to at least the minimum building code requirements of Seismic Zone 4. The site is located near the Los Osos Fault that is considered active, and capable of generating at least a magnitude 6.8 earthquake. Seismic response spectra and probabilistic seismic hazard analyses have been prepared to assist in the design of the project.
- ❖ The main geologic hazard that could impact the project is liquefaction and strong ground motion resulting from near-by or regional earthquakes. Evidence of liquefaction was observed along the shoreline of Morro Bay adjacent to the site following the December 2003 San Simeon Earthquake. The estimated potential for liquefaction is mainly limited to areas near the shoreline of Morro Bay or low-lying areas of the site that are underlain by loose dune sand and shallow groundwater. We have recommended site preparation and grading recommendations that should limit the impact of liquefaction and associated seismic settlement on pump station and standby power building areas.

## 6.2 GRADING – GENERAL

### 6.2.1 Grading

Fill placement and grading operations should be performed according to the grading recommendations of this report. We recommend that, unless otherwise noted, fill and backfill materials be compacted to at least 90 percent relative compaction, as determined by the latest approved edition of ASTM Test Method D1557, unless a higher degree of compaction is otherwise recommended.





## 6.2.2 Suggested Material Specifications

The following materials are referenced in various sections of this report. Additional recommendations for trench backfill materials, and other components of the project, are presented in the sections that follow.

**Aggregate base** shall consist of imported material conforming to Caltrans Standard Specifications for Class 2 aggregate base, Section 26-1.02A. Class 3 material that incorporates reclaimed or recycled materials can also be used as aggregate base, provided the Class 3 material complies with the gradation and quality requirements for Class 2 material.

**Asphalt concrete** shall conform to Caltrans Standard Specifications for Type B asphalt concrete, Section 39.

**Coarse sand to be placed below Floor Slabs** shall consist of imported granular material conforming to ASTM C-33, and shall have no more than 5 percent material passing the passing the No. 100 sieve.

**Drainage material** shall conform to Caltrans Standard Specifications for Class 2 Permeable Material, Section 68-1.025; or Caltrans Class 1 permeable material, or ASTM C-33 No. 8 coarse aggregate (pea gravel) provided the materials are enclosed in a filter fabric. As an alternative, prefabricated geocomposite drainage panels, such as Miradrain can be placed behind retaining walls.

**Drainrock for drywells** shall consist of imported crushed rock or gravel, comprised of hard, durable particles that are free of slaking or decomposition under the action of alternate wetting or drying cycles. Drainrock shall have a durability index of at least 40 when tested according to California Test 229. The material shall be uniformly graded and meet the gradation requirements of ASTM C-33 No. 8 Coarse Aggregate.

**Drainrock for percolation lines** shall consist of imported crushed rock or gravel, comprised of hard, durable particles that are free of slaking or decomposition under the action of alternate wetting or drying cycles. Drainrock shall have a durability index of at least 40 when tested according to California Test 229. The material shall be uniformly graded and meet the following gradation requirements:

Sieve Size	Sieve Opening (mm)	Percent Passing
2 in.	50	100
1 ½ in.	37.5	90 - 100
1 in.	25	30-70
¾ in.	19	0-15
No. 4	4.75	0-5
No. 200	0.075	2





**Geotextile for separation (filter fabric)** shall consist of nonwoven geotextile that conforms to the requirements outlined in the Caltrans Standard Specifications for Filter Fabric-underdrains, Section 88-1.03.

**Geotextile for subgrade stabilization** shall conform to the requirements outlined in Caltrans Standard Specifications for Rock Slope Protection Fabric - Type B, Section 88-1.04.

**Geosynthetic reinforcement** shall consist of either geogrid or geotextile designed for use in subsurface geotechnical slope reinforcement applications. Geosynthetic shall meet the following requirements:

1. The Long Term Design Strength (LTDS) of geosynthetic to be placed behind segmental masonry unit walls shall equal or exceed 5,000 pounds per foot in the primary strength direction. The LTDS of geosynthetic to be placed in conjunction with 1.5h:1v geosynthetic reinforced slope shall equal or exceed 1,000 pounds per foot in the primary strength direction. The Geosynthetic Research Institute (GRI) Standard Practices GG4 and GT7 shall determine the LTDS for geogrid and geotextile reinforcements, respectively.
2. In the absence of specific test data, the partial factors of safety default values for installation damage, creep deformation, chemical degradation, biological degradation, and joint strength as shown on GRI GG4 and GT7, shall apply.
3. Geosynthetic reinforcement shall be resistant to ultraviolet degradation, to naturally occurring alkaline and acid soils conditions, and to attack by bacteria.
4. Certificates of compliance, a minimum 6-inch square sample, and documentation of the LTDS shall be provided for review by the geotechnical engineer prior to the material being brought to the site.

**Geocomposite drain** shall consist of a manufactured plastic core not less than 8 millimeters thick with both sides covered with a layer of filter fabric that will provide a continuous drainage void in the horizontal and vertical directions. Geocomposite drain placed behind retaining walls shall have an impermeable backing. Geocomposite drain to be embedded in the ground shall be double-sided with filter fabric covering both sides of the drainage void.

The drain shall produce a flow rate through the drainage void of at least 10 gallons per minute per foot of width at a hydraulic gradient of 1.0 under a maximum externally applied pressure of 2,000 psf. The core materials and filter fabric shall be capable of maintaining the drainage void for the entire height of the geocomposite drain. Filter fabric shall be integrally bonded to the core materials with the drainage void. Core material manufactured from impermeable plastic sheets having non-connecting corrugations shall not be permitted.

The fabric shall overlap a minimum of 6 inches at all joints and wrap around the exterior edges of the drain a minimum of 6 inches beyond the edge. If additional fabric is needed to provide overlaps at joints and to wrap around the edges of core material, the added fabric shall overlap the fabric on the geocomposite drain at least 6 inches and be attached thereto.



Should the fabric on the geocomposite drain be torn or punctured: 1) the damaged section shall be replaced completely if damage is done to the core material, or 2) if the core material is not damaged than the repair can be performed by placing a piece of fabric that is large enough to cover the damaged area and provide a 1-foot overlap.

**Imported fill material** brought to the site shall be free of organics, oversize rock (that is over 3 inches in diameter), trash, debris, corrosive, and other deleterious materials. Imported materials shall comply with all specified material requirements for the area where the material is being placed. Imported materials used in building areas shall have an Expansion Index of less than 20. Imported soil to be used as bedding, pipe zone, or trench backfill material shall comply with applicable recommendations of this report. Imported material to be placed within 3 feet of finished grade in pavement areas shall have an R-value of at least 40 as determined by California Test 301. Imported fill should be reviewed by the geotechnical engineer prior to being brought to the site; however, imported fill materials shall comply with all specifications for that material as placed at the site.

**Pipe zone material** shall consist of onsite or imported soil having a sand equivalent (SE per ASTM 2419) of at least 30 and conforming to Section 19-3.025B, Sand Bedding, of the Caltrans Standard Specifications.

**Pipe zone bedding material** shall consist of compacted in situ sand or imported material having a sand equivalent of at least 30, and conforming to Section 19-3.025B, Sand Bedding, of the Caltrans Standard Specifications.

**Pipe zone bedding material - gravel** for trench bottom stabilization shall consist of material conforming to either:

- ❖ Caltrans Section 26-1.02A, Class 2 aggregate base, ¾-inch or 1-½ inch (19 mm or 37.5 mm) gradation, R-value requirements are waived,
- ❖ Caltrans Section 90-3.02, Coarse Aggregate Grading; or
- ❖ ASTM C-33 No. 8 Coarse Aggregate.

**Retaining wall backfill material** shall consist of either on-site or imported material conforming to Caltrans Standard Specifications for Structure Backfill, Section 19-3.06, and having a sand equivalent (SE) of at least 30.

**Trench backfill** shall consist of imported or onsite material that is free of organics, debris, oversized material greater than 3 inches, and other deleterious materials. Trench backfill material shall have at least 85 percent of the material passing the U.S. Standard No. 4 sieve, and/or comply with the applicable requirements for the area where the trench backfill is being placed (such as the pavement structural section).



### **6.2.3 Clearing and Grubbing**

Prior to commencing grading operations in building or roadway areas that will receive compacted fill or structures, soil containing debris, organics, pavement, uncompacted fill, or other unsuitable materials, should be removed. Demolition areas should be cleared of old foundations, slabs, abandoned utilities, and soils disturbed during the demolition process. Depressions or disturbed areas left from the removal of such material should be replaced with compacted fill.

### **6.2.4 Fill Placement**

The fill should be placed and compacted to at least the minimum relative compaction recommended in this report. The moisture content of the fill should be between 2 percent below to 2 percent above the optimum. Each layer should be spread evenly and should be thoroughly blade-mixed during the spreading to provide relative uniformity of material within each layer. Soft or yielding materials should be removed and be replaced with properly compacted fill material, prior to placing the next layer. We recommend that fill materials placed in building or pavement areas be mechanically compacted. Ponding or jetting should only be permitted for the pipeline construction when approved by the Engineer, and should not be used as method of fill placement or compaction in building areas.

Rock, gravel and other oversized material, greater than 4 inches in diameter, should be removed from the fill material being placed. Rocks should not be nested and voids should be filled with compacted material.

When the moisture content of the fill material is below that sufficient to achieve the recommended compaction, water should be added to the fill. While water is being added, the soil should be bladed and mixed to provide a relatively uniform moisture content throughout the material. When the moisture content of the fill material is excessive, the fill material should be aerated by blading or other methods. Fill should be spread in lifts no thicker than approximately 8 inches prior to being compacted. Fill and backfill materials may need to be placed in thinner lifts to achieve the recommended compaction with the equipment being used.

We recommend that prior to placing fill materials, that the existing soils be removed to a depth of at least 2 feet below the existing ground surface. Where fill materials are to be placed on slopes steeper than 4:1, the fill should be keyed and benched into the slope. The base of the fill should initiate from a base key centered at the toe of the slope. The base key should be excavated at least 2 feet below the existing ground surface, or to relatively firm material. The width of the base key should be at least 10 feet, and extend at least 5 feet beyond the toe of the slope. Subsequent benches should extend into at least firm to hard soil and remove the upper 2 feet of the existing soils. The base key and subsequent benches should be sloped at 2 percent into the hillside.



### 6.3 SEISMIC CONSIDERATIONS

The geologic hazards assessment for the project is summarized in Section 5 of this report. The following seismic considerations provide information needed to design the facility.

#### 6.3.1 Seismic Data

The site is within Seismic Zone 4 based on the 2001 California Building Code and 1997 Uniform Building Code. On the basis of our characterization of the site seismicity, we recommend that the following values be used for seismic design:

#### Summary of Seismic Data

Uniform Building Code Chapter 16, Table Number	Seismic Parameter	Value for Buildings
16-I	Seismic Zone Factor (Z)	0.40
16-J	Soil Profile Type	(S <sub>D</sub> ), Stiff Soil
16-Q	Seismic Coefficient (C <sub>s</sub> )	0.44N <sub>a</sub>
16-R	Seismic Coefficient (C <sub>v</sub> )	0.64N <sub>v</sub>
16-S	Near Source Factor (N <sub>a</sub> )	1.3 <sup>1</sup>
16-T	Near Source Factor (N <sub>v</sub> )	1.6

<sup>1</sup> Los Osos fault is mapped approximately 1 km south of treatment plant site. Near source factor of 1.1 can be used if criteria listed in code Section 1629.4.2 are met.

#### 6.3.2 Liquefaction and Seismic Settlement

The potential for liquefaction or seismic settlement to impact the project is discussed in Section 5.8 of this report. We expect that there is a low potential for liquefaction to impact the treatment plant areas, provided the recommended site grading is performed. Estimates of seismic settlement are provided in the foundation design sections of this report. The effluent disposal sites are generally underlain by relatively dense dune sand and Paso Robles Formation that extend below the groundwater table, and are not considered susceptible to liquefaction.

Liquefaction could impact the pump station and pipeline areas. We have recommended site preparation and grading that will reduce the potential for liquefaction and seismic settlement to impact the pump station areas. While liquefaction hazards are typically not mitigated as part of the design and construction of a pipeline project, the potential hazards associated with liquefaction can be addressed in emergency response planning, sometimes referred to as "soft fixes". Soft fixes typically consist of having a plan in-place to address the hazards, such as can be achieved by storing supplies and equipment associated with the pipeline that can be difficult to obtain or have long lead times.



### 6.3.3 Fault Rupture Hazards

There is a low potential for fault rupture to impact the project. The wastewater treatment site is not within an Alquist-Priolo Fault Hazard Zone, or an area of any known mapped faults or fault trace.

A segment of the Los Osos fault referred to as "Strand B" was inferred to pass through the community of Los Osos, generally along the alignment of Ferrell Avenue (DWR 1989, Asquith 1997). Recent studies by Cleath and Associates (2003a, 2003b, 2003c) did not find evidence of the fault, and suggest that the inferred anomaly is not associated with faulting but with shallow perched groundwater layers that are present in the vicinity of the previously mapped fault. There is therefore a low potential for fault rupture to impact the site.

## **6.4 PIPELINE NETWORK**

### **6.4.1 Backfill Considerations**

Engineering fill material for the pipeline network will consist of bedding material, pipe zone material, and trench backfill material. The MWH nomenclature for the zones within the pipeline trenches are as follows: 1) the pipe zone is the cross section area of the trench extending from the trench subgrade to 12 inches above the top of pipe, 2) the bedding zone is defined as pipe zone material extending from the trench subgrade to the bottom of pipe; 3) the embedment zone is defined as the cross sectional area extending from the top of the bedding to the top of the pipe; and 4) the trench backfill zone is defined as the cross sectional area of the pipeline trench extending from the top of the pipe zone to the bottom of the structural pavement sections or the top of the trench excavation where the trench is outside pavement areas. The zones within the pipeline trench are shown on Plate 9 - Schematic Trench Diagram. Suggested material specifications for bedding, pipe zone and trench backfill are provided in the previous section of this report.

### **6.4.2 Use of On-site Materials**

Select fill materials for the pipeline network will consist of bedding, pipe zone, and trench backfill material. On the basis of our laboratory tests and field explorations, our opinion is that dune sand ( $Q_s$ ) material consisting of poorly graded sand (SP) will likely be suitable for use as pipe zone, bedding, and trench backfill material. Soils classified as poorly graded sand with silt (SP-SM) should be considered to have marginal suitability; however, the tests results for most of the samples with this classification complied with the recommended criteria for select backfill materials. We expect that soils classified as silt (ML), sandy silt (ML), silty sand (SM), sandy clay (CL), and clay (CL/CH) and materials encountered below the groundwater table will not be suitable for use as bedding and pipe zone material.

The majority of the site is underlain by dune sand. After the surficial topsoil and artificial fill materials are stripped away, the majority of underlying dune should generally consists of sandy material that can be used in the pipeline's construction. The limits of suitable and non-suitable bedding and pipe zone material should be evaluated during construction based on the soil conditions encountered at that time. On-site material to be used as pipe zone and pipe zone bedding material should be tested for compliance with the suggested materials specifications of this report (generally consisting of sandy material having a sand equivalent greater than 30). If on-site soils are to be used as bedding and pipe zone material, the contractor will likely need to exercise care during excavation such that potentially suitable materials are not contaminated or mixed with the overlying or interbedded finer grained soils. On the basis of our field explorations and laboratory testing, it is our opinion that approximately 80 to 90 percent of the dune sand deposits encountered below a depth of 5 feet will generally comply with our recommendations for bedding and pipe zone material.

On the basis of our field exploration, areas of on-site materials will likely be encountered during construction that are wet and/or have a moisture content unsuitable for compaction, as-excavated. The estimated "depth to first groundwater" as encountered at various excavations







and periods between 1997 and 2003 is shown on Plate 8c. Where the invert extends near or below the groundwater level shown, we anticipate that the moisture content of the excavated soil may not be suitable for compaction. Materials that are wet of optimum as-excavated, but are otherwise suitable material, can likely be aerated or dried to a lower moisture content suitable for compaction and then be used as trench backfill material or pipe zone material. It is our experience in the project area, however, that periods of wet or foggy weather can occur that make drying of soil materials relatively difficult. Wet soil will likely need to be hauled and stockpiled off site, spread and disked to aerate the material, and then hauled back onsite to be placed as backfill once the material has been dried.

#### **6.4.3 Foundation Support and Trench Bottom Stabilization**

Where soft, wet, or yielding subgrade material is encountered, it is recommended that the soils exposed in the bottom of the trench be stabilized prior to placement of bedding material. The trench subgrade should be stabilized to a firm and unyielding condition that will allow for the recommended compaction to be provided in the bedding, pipe zone, and trench backfill materials. Stabilization of the subgrade typically consists of removing a portion of the subgrade and replacing it with a thicker layer of gravel bedding material. Where the base of the trench has been disturbed or is not properly dewatered, the contractor should be responsible for removing the disturbed material and replacing it with compacted fill. The contractor may elect to scarify and compact the exposed subgrade of the trench to assist in achieving compaction in the bedding, if they choose.

To provide for stabilization of the subgrade, we recommend that the project specifications provide for review of the pipe subgrade conditions at the time of construction, and allowances for increasing the quantity of trench excavation and bedding thickness below the pipe at the contract unit rates, if needed, to help stabilize the foundation support soils below the trench.

Where soft, wet, or yielding soil conditions are encountered at the bottom of the trench, we preliminarily recommend that the trench be stabilized with at least 12 inches of gravel bedding material. Gravel bedding should conform to the material recommendations presented in this report. Where open-graded materials are used for bedding and stabilization (such as pea gravel), the gravel should be encased in a geotextile to reduce the potential for the adjacent sandy soil to migrate into the trench. The actual thickness of gravel should be evaluated based on the subgrade conditions encountered and bedding material used during the construction. The gravel used in stabilization of the subgrade can be included in the recommended bedding thickness below the pipe. A cushion of sand bedding can be provided over the gravel and geotextile, if needed, to help set the pipe.

We expect that stabilization of the pipe subgrade will mainly be needed where the bottom of the trench is near or below the groundwater table. Preliminarily, areas of wet subgrade conditions can be estimated areas by comparing the estimated bottom of the trench to the groundwater depths encountered in our explorations, as depicted on Plate 8c. The dune sand is typically wet and can be saturated to a height of approximately 2 feet above the static groundwater level. We recommend that the project specifications provide for stabilizing the



trench subgrade in areas where wet soil or groundwater could be encountered during excavation, but allow for those limits to be revised based on the conditions encountered at the time of construction.

#### **6.4.4 Pipe Zone Bedding Material**

Bedding is select material placed between the trench subgrade and the bottom of the pipe. The bottom of the trench should be stabilized in association with the placement of bedding materials according to the recommendations of the previous section. Bedding material can consist of imported sand, gravel, crushed aggregate, or excavated on-site material having a sand equivalent of at least 30 and conforming to the suggested materials specification of this report. Where open graded gravel materials are used as bedding, a geotextile for separation should be provided around the bedding material to reduce the potential for the native soil to pipe into the bedding material. Where gravel is placed to stabilize the subgrade below the pipe, the gravel should be continued up to the springline of the pipe as shown on Plate 9.

The bedding thickness below the pipe should be at least 6 inches or one third of the pipe diameter, whichever is greater. Where the in-situ materials below the bottom of pipe meet the recommended material requirements for pipe zone bedding, the bedding material can be omitted provided the trench subgrade is prepared and compacted as recommended below. Bedding materials should be compacted to at least 90 percent relative compaction, prior to placing the pipe or the pipe zone materials.

Where the in-situ material within 9 inches of the bottom of the pipe meets the recommended material requirements for bedding, bedding can consist of scarifying the existing soil, and compacting the in-situ material in-place to at least 90 percent relative compaction. The depth of compaction should extend to at least 9 inches below the bottom of the pipe. The purpose of scarifying the subgrade is to evaluate if there are rocks or deleterious objects within the bedding thickness. Care should be taken that scarification or disturbance of the soil does not occur below 9 inches or the depth of compaction. Excavation of the prepared bedding should be provided below the bell of the pipe such that the entire pipe is supported and in firm contact with the bedding. Additional material meeting the requirements for pipe bedding can be used to fill depressions left from trench excavation or compaction, if needed.

#### **6.4.5 Pipe Zone Material**

Pipe zone material placed above the bedding to at least 12 inches above the top of the pipe should be compacted to at least 90 percent relative compaction prior to placing trench backfill. Compaction within the pipe zone should be performed such that the pipe is fully supported, and such that excessive deformation or damage to the pipe does not occur. Material should be hand shoveled and sliced below the haunches of the pipe during placement to provide support for the pipe and assist with compaction.





#### 6.4.6 Trench Backfill

Trench backfill is material placed above the pipe zone material and below the ground surface, finished grade, or pavement structural section. Trench backfill should consist of excavated on-site soil that conforms to the suggested material specification of this report, or imported material that is free of organics, debris and other deleterious materials. Trench backfill should be compacted to at least 90 percent relative compaction, except in roadway areas where trench backfill placed within 3 feet of finish grade of the pavement surface should be compacted to at least 95 percent relative compaction.

#### 6.4.7 Backfill and Compaction

Fill placement and grading operations should be performed according to the grading recommendations of this report. We recommend that fill materials be compacted to at least 90 percent relative compaction, as determined by the latest approved edition of ASTM D1557, unless a higher degree of compaction is otherwise recommended. We recommend the following minimum relative compaction be provided for the locations indicated:

Location	Recommended Minimum Relative Compaction
General	90 % U.O.N.
Pipe Zone and Bedding	90 % U.O.N.
Trench backfill in non-pavement areas or placed greater than 3 feet below finished grade in pavement areas	90 % U.O.N.
Trench backfill placed within 3 feet of finished grade in pavement areas	95 %
Aggregate Base or Subbase	95 %
Asphalt Concrete	95 %
Building Areas	95 %

U.O.N. = unless otherwise noted

##### 6.4.7.1 Mechanical Compaction

The backfill should be placed and compacted to at least the minimum relative compaction recommended in this report, as determined by Standard Test Method ASTM D1557. Each layer should be spread evenly and should be thoroughly blade-mixed during the spreading to provide relative uniformity of material within each layer. Soft or yielding materials should be removed and replaced with properly compacted fill material, prior to placing the next layer. Rock, gravel, and other oversized material should be removed from the backfill material being placed as to conform to our recommendations for trench backfill material. Rocks should not be nested and voids should be filled with compacted material.

Impact type compactors, such as hydrohammers, can damage or displace pipes during compaction and should not be permitted for use on this project. The amount of effort and ability to compact the soil is dependent on the soil type, moisture content, and suitability of the compaction equipment for the conditions encountered. The backfill materials are expected to





consist of predominantly granular material that can typically be compacted using static or vibratory, smooth drum, vibratory plate, short-sheepsfoot compaction wheels, or similar compactors. Long-sheepsfoot and similar kneading type compactors are generally not suited for compaction of granular soils.

When the moisture content of the backfill material is below that sufficient to achieve the recommended compaction, water should be added to the fill. While water is being added, the soil should be bladed and mixed to provide a relatively uniform moisture content throughout the material. When the moisture content of the fill material is excessive, the backfill material should be aerated by blading or other methods. Fill should be spread in lifts no thicker than approximately 8 inches prior to being compacted. Fill and backfill materials may need to be placed in thinner lifts to achieve the recommended compaction with the equipment being used.

#### **6.4.7.2 Jetting and Ponding**

Jetting and ponding of water to assist with compaction should not be permitted in areas of poorly drained or wet soil or in areas of high groundwater. Jetting may be used to compact trench backfill in areas where groundwater is not present and the in-situ soils are well drained. Jetting should not be permitted until after the pipe and pipe zone materials have placed and compacted with mechanical equipment. We recommend that trench backfill materials to be compacted by jetting or ponding have a sand equivalent of at least 30 (assumed coefficient of permeability faster than  $1.0 \times 10^{-3}$  cm/s). Water used for jetting shall be clean potable water free of contaminants, corrosive elements, and acceptable and compliant with applicable water quality control standards and regulations.

The pipe used for jetting should be capped at its end and perforated along its side as to allow water to flow out into the materials being compacted. The jet pipe should be capable of penetrating to within 2 feet of the bottom of the lift being compacted. The water used during the jetting process should not be allowed to pond or pool at the bottom of the trench. In addition, mechanical or vibratory compaction should be provided to supplement the compaction by jetting. Jetting and ponding should not be permitted in the upper 3 feet of the pipeline trench. Prior to beginning backfill placement, we recommend that the contractor establish a "test" section of pipeline to demonstrate that the proposed compaction method achieves the specified relative compaction. Compaction should be provided in the pipeline bedding and pipe zone material prior to placing trench backfill.





### 6.4.8 Pavement Structural Section Design

Typical practice is to replace pavements with the same structural section as the existing section, or to design the structural section according to Caltrans procedures. Roadway structural section information, as encountered in explorations, is discussed in Section 4.4.1.1 of this report. We have provided structural section recommendations for the design of asphalt concrete pavements on the basis of procedures presented in the Caltrans Highway Design Manual. Where trench backfill materials are placed in pavement areas, the upper 3 feet of the backfill materials should be compacted to at least 95 percent relative compaction. On the basis of our laboratory testing, observation of the subgrade materials encountered, and the anticipated trench backfill material, we selected an R-value of 50 for the design of the structural sections. We can provide structural section recommendations for alternative R-values, if requested. We recommend the following asphalt concrete (AC) and aggregate base (AB) thicknesses for 1- and 2-layer structural sections.

Ti	AC Thickness (inches)	AB Thickness (inches)
4	4	—
	3	4
5	4 ½	—
	3	4
6	5 ½	—
	3 ½	4
7	6 ½	—
	4	4 ½
8	8	—
	4 ½	6

The R-value used for design was selected on the basis of the soil conditions encountered in the explorations, and laboratory testing of selected samples obtained from the borings. The upper 3 feet of trench backfill material should have an R-value of at least 50.



#### **6.4.9 Trenchless Installations**

We understand that trenchless techniques could be used to construct the pipeline at the following locations:

- ❖ The north end of Solano Street;
- ❖ The intersection of Pecho Road and Henrietta Avenue;
- ❖ Portions of Clelland Avenue, a paper street between the westerly terminus of Mar Vista Drive and Los Osos Valley Road, to avoid removing existing structures and trees, and
- ❖ As an alternative to open cut construction.

Trenchless installations can be performed using a tunnel boring machine, commonly referred to as microtunneling, or by jacking the pipe and excavating the soil that enters the pipe using augering equipment. This technique is generally referred to as "jacking and boring". Jacking and boring is best suited for firm, dry ground that is relatively free of rock or large obstructions such as gravel, cobbles, or boulders. Special techniques, such as using a tunnel boring machine with a closed-heading and pressurized slurries, may be needed to address the subsurface conditions encountered.

##### **6.4.9.1 Soil and Groundwater Conditions**

The site is generally underlain by dune sand deposits overlying dense sand comprised of Paso Robles Formation, older alluvium, and older sand dune deposits. Explorations performed in the Solano Street and Henrietta Avenue areas, where trenchless pipe installations are being considered, encountered loose sand and groundwater. Groundwater was encountered at 3 to 4 feet below the pavement surface during the January 1997 field exploration program (Fugro 1997). These types of subsurface conditions can be the most challenging that boring contractors can encounter.

We expect that the advancement of the boring operation will be relatively difficult as a result of: 1) the heading is not self-supporting as a result the presence of loose dune sand that can cave into the excavation, 2) wet soil conditions, and 3) groundwater above the invert elevation. A closed heading boring machine and the use of drilling mud or pressurized slurries will likely be needed to maintain support face support at the tunnel heading.

##### **6.4.9.2 Boring Tolerances**

Typical vertical and horizontal tolerances for jacking and boring are 1 percent of the length of the bore. We understand from MWH that design tolerances for a 400-foot reach of sewer pipe could be about  $\pm 2$  inches on line and  $\pm 1.5$  inches on grade. Closer tolerances can be achieved using microtunneling equipment, and/or by requiring closer monitoring of the operation during advancement of the bore. The monitoring would consist of periodically removing the auger from the bore, surveying the alignment of the pipe or casing, and then making necessary changes to the jacking pressures to adjust the advancement of the bore.



Frequent monitoring and adjustments can slow the progress of the jacking and boring operation. Alternatively, tunneling boring machines provide closer tolerances than conventional jack and bore construction, at greater expense, but are likely better suited for construction of the gravity sewer lines proposed for this project.

#### 6.4.9.3 Jacking Resistance

The local resistance of the soil to pipe jacking will depend upon the condition of the soil at the jacking location as well as the contractor's methods and equipment. Therefore, it is not possible for us to predict the required jacking force with a reasonable degree of accuracy. The reaction for the jacking equipment will be provided by passive pressure from a plate bearing on the back of the jacking pit. As input to the contractor's evaluation, the ultimate passive pressure corresponding to the minimum depths below the ground surface and jacking plate dimensions can be estimated as follows:

Depth Below Ground Surface (feet)	Minimum Plate or Block Dimension (feet)	Ultimate Passive Pressure (psf)*
Less than 3	--	0
3 or greater	1.5 square	1,200
5 or greater	2.0 square	2,000
8 or greater	3.5 square	3,200

\*Use ½ of the recommended passive resistance when below groundwater

The estimated passive pressures assume that the support soils for the jacking plate are above the groundwater table, or that the excavation will be dewatered prior to, and during, jacking. Several inches of lateral deflection will likely occur as the jacking force approaches the ultimate passive pressure available. Limiting the jacking pressure behind the plate, providing a thicker or stiffer bearing plate, and various boring techniques can be used to limit the soil bearing pressures and associated deformation of the soil behind the plate.

#### 6.4.9.4 Monitoring and Instrumentation

Monitoring of ground surface movements should be provided to assess whether or not settlement or heaving is impacting the road surface as a result of the pipe installation. The project specifications should require the contractor to submit a detailed plan of the monitoring program and pipe installation procedures. The program should monitor surface movement at a minimum of 3 locations along the proposed trenchless installation, and at no more than 100-foot spacings during boring.

At each monitoring location, surface monuments should be established to measure surface deflection at the centerline of the pipe, and 6 feet left and right of centerline. The frequency of monitoring and tolerances for the monitoring program are summarized as follows.





Point	Frequency	Tolerance	Maximum Allowable
Surface	Hourly when heading is within 15 feet of the monitoring point; otherwise daily.	$\pm 0.25$ inches	0.5 inches

When the tolerance is exceeded, modifications to the pipe installation should be made to prevent excessive settlement or heave. If the heave or settlement exceeds the maximum allowable, then mitigation, such as grouting and repair to the roadway, should be provided.

#### **6.4.9.5 Post-Installation Grouting**

Post-installation grouting should be performed when settlements along any portion of the pipeline alignment exceed the allowable settlements indicated in the preceding section of this report. Grouting should be performed to fill voids created adjacent to the emplaced pipe during construction. As a minimum, grouting points should be installed at regularly spaced intervals of 5 feet along the area of settlement. When the grouting can be performed from within the jacked casing or pipe, grout points should be set alternating at 30 degrees from plumb each side of the vertical centerline of the top of the pipe. Grouting around the casing should be attempted at all grout points. The jacking and boring should be monitored to identify areas of caving, raveling ahead of the casing, or removal of large particles that may require grouting.

#### **6.4.9.6 Environmental Considerations**

The boring contractor may be required to perform a limited environmental site assessment prior to or during boring to determine whether potentially "gassy" conditions exist at the proposed jack and bore site in accordance with the State of California Division of Safety and Health Tunneling Safety Order. The boring contractor should assume that "gassy" conditions exist at the bore locations, unless a determination is made prior to initiating the tunneling.





#### 6.4.10 Thrust Resistance

Where pressurized portions of the pipeline change direction abruptly, resistance to thrust forces can be provided by mobilizing frictional resistance between the pipe and surrounding soil, and by the use of a thrust block, or by a combination of the two.

We understand that pressurized pipelines could be designed to resist thrust using restrained joints in conjunction with mobilized pipeline/soil resistance. A coefficient of lateral earth pressure,  $K_o$ , value of 0.7 can be used in conjunction with a coefficient of friction of 0.35 or 0.20 between the pipe and granular backfill material in contact with DIP or PVC pipes, respectively. The recommended values assume that granular pipe zone materials will be placed adjacent to the pipe, as recommended in this report.

Thrust blocks can be designed to resist lateral forces based on the passive resistance acting on the bearing side of the block, and the estimated frictional resistance acting along the base of the block. Thrust blocks should be designed with a minimum cover of 3 feet below finish grade. The passive pressures presented in the previous section of the report are considered to be applicable for the design of thrust blocks along the pipeline route. We recommend that a coefficient of friction of 0.45 acting on the base of thrust blocks be used for design.

We recommend that thrust block be designed assuming submerged overburden soils. A buoyant soil unit weight of 48 pounds per cubic foot for the overburden soils should be used when computing the frictional and passive resistance on thrust blocks or pipes with restrained joints.

#### 6.4.11 Backfill Loading on Pipe

The sewer pipe should be designed to resist vertical loads resulting from the backfill. We estimated the vertical load on the pipe using the Marston Theory of Loads on Underground Conduits presented in Spangler and Handy (1982). Vertical loads were estimated for rigid and flexible ditch conduits. On the basis of Marston Theory, the load on the pipe will depend on the stiffness of the conduit relative to the stiffness of the trench backfill materials. The estimated loads on "rigid" pipes should be used for stiff conduits (such as concrete, ductile iron or clay pipe), or cases where the backfill materials are loosely compacted. The estimated loads on "flexible" pipes should be used for conduits that will deform in a manner similar to the backfill (such as for PVC or other plastic pipes), and where the backfill is compacted to at least 90 percent relative compaction. It should be noted that plastic pipes where the backfill is placed in a relatively loosely compacted state (less than 90 percent relative compaction) could experience loads higher than those estimated.

The estimated load on the pipe assumes that the trenches will be backfilled using on-site or imported granular soils having a maximum cover thickness of 24 feet. No factor of safety was applied to the estimated loads. A summary of the estimated load on flexible and rigid conduits follows:



Estimated Load on Ditch Conduits (pounds/linear foot)				
Pipe Condition	Pipe Diameter (inches)	Incination of Trench Slopes		
		Vertical	1h:1v or steeper	1.5h:1v or steeper
Rigid	up to 6	410	720	900
	up to 12	620	1250	1610
	up to 18	830	1790	2320
Flexible	up to 6	130	140	150
	up to 12	280	310	320
	up to 18	440	490	500

The estimated loads are provided on the basis of a maximum 24-foot cover thickness: smaller loads will result for shallower thicknesses of material. The loads on the pipe can be reduced by providing modified trench cross sections that reduce the width of the trench at the top of the pipe, or by providing stress absorbing materials above the pipe. We can provide recommendations for alternative trench details, if requested.

#### 6.4.12 Modulus of Soil Reaction (E')

Flexible and semi-rigid pipes are typically designed to withstand a certain amount of deflection from applied earth loads. Those deflections can be estimated with the aid of equations developed by Spangler and Handy (1982). We used procedures recommended by Hartley and Duncan (1987). We have recommended E' values for general conditions that were estimated for pipeline trenches backfilled with granular materials complying with the recommendations of this report, and for in-situ materials consisting of normally consolidated sand. On the basis of our evaluation, we recommend that the following values of E' be used for pipe design.

Case or Limits	Recommend E' value
General with depth of cover of 3 to 5 feet:	1,000 psi
General with depth of cover between 5 and 10 feet:	1,500 psi
General: for each additional foot of cover below 10 feet:	1,500 psi + 100 psi x (Depth of cover below 10 feet)

The E' value was estimated as the weaker of the pipe zone material or in-situ material beyond the springline of the pipe. The recommended E' value was selected based on the soil conditions encountered at the site. The geotechnical engineer should review the trench during construction. If unsuitable materials are encountered along the spring line of the pipe, the trench detail and design of the pipe should be reviewed to evaluate if modifications to the design are needed to provide for the lower springline support. Placing slurry or a concrete cradle below the haunches of the pipe can help to provide additional springline support for pipes embedded in relatively weak soils.



## 6.4.13 Construction Considerations

### 6.4.13.1 Excavation

As part of the Fugro (1997) field exploration program, 7 backhoe trenches were excavated at the site. The logs of the trenches are presented in Attachment C3. Photographs of the trenches are presented on Plates 10a to 10g. On the basis of the trenching, it is our opinion that the main geotechnical considerations for the trench excavations will be:

- ❖ The soils encountered at the site generally consist of sandy soils. The trenches that were excavated at the site were performed using a rubber-tire mounted backhoe with a 30-inch wide bucket. Trench excavations can likely be performed using conventional backhoe or excavator type equipment typically used for pipeline construction.
- ❖ The soils encountered generally consist of sand having low or no cohesive strength. These materials generally will not stand in unsupported excavations with vertical sides. Depending on the soil moisture conditions at the time of construction, the soil may exhibit apparent cohesion for a time; however, even temporary unsupported excavations with vertical sidewalls should be considered to be potentially unstable and subject to collapse. Excavations should be sloped or shored in accordance with OSHA requirements.
- ❖ Groundwater was encountered at relatively shallow depths in the borings, trenches and CPT soundings, as discussed below. Where groundwater was encountered in our trenches, we observed that the walls of the excavation typically became unstable and collapsed or flowed into the excavations. Excavations extending below the groundwater table should not be considered feasible without the use of dewatering prior to excavation. Areas of potentially high groundwater are shown as Zones A and B on Plate 9.

### 6.4.13.2 Dewatering

Groundwater conditions are notoriously shallow in many areas of the communities of Los Osos, Baywood, and Cuesta-by-the-Sea. The estimated groundwater elevations at the site during years of 1990 and 1997 are summarized on Plates 8a and 8b. The estimated depth that groundwater was encountered in various excavations performed during the period of 1997 to 2003 is shown on Plate 8c. In some areas of the site groundwater daylights on the surface, resulting in areas of ponding, springs, and seeps. Groundwater and surface water conditions along the coastal areas in Baywood and Cuesta-by-the Sea are likely influenced by tidal fluctuations. Groundwater changes will also fluctuate seasonally, and with variations in storm water runoff, irrigation schedules, rainfall, and other factors.

On the basis of the groundwater conditions encountered at the site, it is our opinion that dewatering will be needed to construct the pipeline trenches. The contractor should be responsible for selecting the method of dewatering, and for maintaining the dewatering system, as-needed, to allow for the pipeline construction. Dewatering should consist of lowering





groundwater levels to at least 1 foot below the bottom of the trench prior to excavation. Dewatering should be performed such that water does not seep through side walls of the trench, and is significantly below the invert of the pipe to allow for stabilization of the subgrade and compaction of the pipe zone bedding material. Dewatering facilities, such as sump pits, wells, and well points should be designed with filters such that sand and fine-grained materials are not removed from the soil during dewatering operations. Dewatering facilities should be installed in advance of beginning excavation, and time should be allowed for lowering of the groundwater table before beginning excavation. Prior to mobilizing equipment to the site, the contractor should be required to submit a dewatering plan for review by the design consultant and geotechnical engineer. A qualified registered professional should prepare the dewatering plan.

Tests for falling head permeability and grain size distribution were performed on selected samples obtained from the borings (CFS, 2000b; Fugro, 1997; Fugro, 1996). The results of these and the other laboratory tests are summarized in the attachments in Volume 2 of this report. Although the soil conditions encountered generally consist of sandy materials, layers of moderately cemented, dense sand and clay were encountered in some of the explorations at depth. It is our experience that these types of conditions can perch groundwater, and subsequently reduce the effectiveness of dewatering wells constructed at depth to drawdown the groundwater table. The contractor should perform field pump tests to evaluate the depth and spacing of dewatering points or wells prior to submitting the dewatering plan.

#### **6.4.13.3 Temporary Slopes**

The soils encountered within the expected depths of excavation consist predominantly of sand (SP) with varying amounts of silt. In our opinion, the soils encountered will not maintain a vertical slope. Temporary slopes should be braced or sloped according to the requirements of (Cal) OSHA. The contractor should be responsible for job site safety, and for the design of temporary slopes or shoring. As guidance for design, we estimated inclinations for temporary slopes based on the OSHA guidelines. The slope inclinations recommended by OSHA guidelines are provided on the basis of soil classification categories. OSHA provides definitions for classifying the soil as Type A, B or C material, or as solid rock. Slopes designed on the basis of the soil classification can be used without performing site-specific engineering analysis.

The dune sand and alluvium consist of loose granular soil, mostly sand (SP, SM), Type C soil. The sandy soils will not stand vertically, nor should be considered stable when cut vertically. Temporary construction slopes will need to be either flattened to a stable slope inclination or shored to allow for the pipeline construction. For Type C soil conditions, OSHA guidelines indicate that temporary construction slopes should be constructed at inclinations of 1-1/2:1 (horizontal to vertical) or flatter for trench depths of up to 20 feet. The slope inclination assumes that the soils consist of relatively clean sand that would be dewatered prior to initiating excavation. Slopes should not be considered stable if seepage can daylight on the slope or groundwater is expected within the planned depths of excavation. If excavations need to extend below the groundwater table, dewatering should be provided in advance of the excavation to avoid the potential for groundwater to daylight on the slope.



#### 6.4.13.4 Shoring

The use of continuous metal, plywood, or timber, sheeting, or jackable shields, will likely be needed to support vertical trench walls, particularly for those areas adjacent to or within paved areas, so that sloughing of soils and undermining of paved areas and adjacent utilities can be minimized. Shoring systems should be designed in association with dewatering system for the construction. Trench walls lacking tight sheeting or adequate sidewall support in those areas could experience trench wall instability or movements that could damage adjacent pavements, utilities, or structures. Continuous excavation support should be anticipated to reduce the potential for sloughing of soils.

Sheet piles that extend below the pipe zone should be cutoff above the pipe zone and be abandoned in-place unless the contractor can demonstrate that specific precautions can be made to avoid disturbance to the pipe or loosening of the backfill as a result of the extraction of the sheet piles.

"Dragging a shield" is a common method of providing worker safety during trenching and pipe construction. However, unless specific provisions exist to emplace the shield tight against the sidewalls, a shield provides no support for the trench sidewalls and should not be considered a shoring system. As observed in backhoe excavations, caving typically occurred as the material was being excavated below a depth of approximately 5 to 7 feet. Shoring will likely need to be installed simultaneously with or prior to excavation to reduce the potential for caving of the sidewalls.

According to OSHA, the lateral earth pressure acting on trench shoring can be estimated as a uniform soil pressure plus a surcharge for traffic loading. For the Type C soil conditions discussed in the previous section of this report, OSHA recommends that the active earth pressure acting on trench shoring be estimated as:

$$\sigma_a = 80H + 72 \text{ psf for soil being retained above the water table}$$

$$\sigma_a = 40H + u + 72 \text{ psf for soil being retained below the water table}$$

where:

" $\sigma_a$ " is the uniform, active earth pressure acting on the shoring, in pounds per square foot (psf) with a level backslope

"H" is the height of the soil that is being retained in feet

"u" is the water pressure that increases at 62.4z, with z = depth in feet

"72 psf" is the traffic surcharge

Excavated material should generally be stockpiled away from excavations, or the shoring systems should be designed for the additional surcharge from the stockpiled material. The stock piled materials, or other surcharges, can be assumed to not influence the design of the shoring systems where the materials are located beyond a 1:1 line projected upward from the bottom edge of the trench.



#### 6.4.13.5 Soil Properties

Based on the soil conditions encountered in our borings, we recommend the following geotechnical parameters for use in the contractors evaluation of temporary slopes or shoring systems:

Friction Angle ( $\phi$ ):	33°
Cohesion (c):	0
Unit Weight of Soil ( $\gamma$ ):	120 pcf (above the water table)
Effective Unit Weight of Soil ( $\gamma'$ ):	60 pcf (below the water table)
Unit Weight of Water ( $\gamma_w$ ):	62.4 pcf

The contractor should review the recommended geotechnical parameters during design and construction to evaluate whether the properties are appropriate for the design, and provide additional testing, exploration, and/or analysis as required.

#### 6.4.13.6 Existing Structures

The proposed project will generally be constructed in areas that are relatively heavily occupied by residential and commercial type developments. The contractor should be responsible for the design of shoring systems such that the construction will not result in settlement or instability of adjacent structures, private property, or existing roadway improvements that will not be replaced as part of the project. In general, surcharge loads from existing structures can be neglected if the structure is behind a 1:1 line projected upwards from the nearest bottom edge of a shored trench excavation, or the building is setback at least 10 feet horizontally from properly sloped excavations. If excavations are made within the zone of influence of adjacent structures or foundations, the contractor should design the slope or shoring system for the additional surcharge load.

In addition, where excavations are made adjacent to structures, temporary slopes should be constructed at stable slope inclinations such that the soil does not ravel on the face of the excavation. Groundwater seepage that daylights on the face of temporary slope should not be permitted. As discussed in Section 6.4.13.2 of this report, dewatering systems should be designed with proper filters such that fines are not removed from the foundation support soils of adjacent structures.



## **6.5 PUMP STATION DESIGN**

### **6.5.1 Wet Wells and Vaults**

Seven pump stations and up to 16 pocket pump stations are planned in various low lying areas of the site. The pumps will generally be installed in manhole type structures with wet wells and vaults extending to depths of approximately 6 to 18 feet below the existing ground surface, respectively. The subsurface conditions encountered in the pump and lift station areas generally consist of sandy soils with varying groundwater levels as described in this report.

#### **6.5.1.1 Lateral Earth Pressures**

Below grade structures, such as wet wells and vaults, should be designed to resist lateral earth pressures. The lateral earth pressure acting on buried cylindrical structures was estimated for the planned vaults and wet wells that will be designed in association with the pump stations, and is summarized on Plate 11. We recommend that buried cylindrical structures be designed to tolerate fully submerged and dry backfill conditions. The recommended earth pressures assume that the structures will be backfilled with Retaining Wall Backfill material conforming to the materials recommendations of this report, or be sunk into native sandy soils using caisson type construction. Non-cylindrical buried structures or vaults can be designed according to the lateral pressure recommendations of Section 6.6.6 of this report.

#### **6.5.1.2 Uplift Forces**

Below grade structures should be designed to resist uplift forces resulting from the buoyancy of the structure and high groundwater conditions. The base of the structure should be ballasted such that the buoyant unit weight of the slurry seal (if needed), the base of the well, and the structure itself will resist uplift forces assuming fully submerged backfill conditions. If a structure is located within an area subject to flooding, the uplift force should be estimated considered the high water level. Resistance to uplift can be resisted by the buoyant dead weight of the below the grade structure itself, frictional resistance along the sides of the structure, and the dead weight of any above grade portion of the structure.

The frictional resistance acting on the sides of the structure can be estimated as the horizontal stress applied on the outside of the well or vault times the friction coefficient between the soil and the structure. The horizontal stress acting on the outside of the structure can be estimated from Plate 11. The horizontal stress should be estimated for submerged backfill conditions. We recommend that an ultimate friction coefficient of 0.4 be used to estimate the frictional resistance along sides of the structure. A factor of safety of at least 1.25 should be applied to design the structure to resist uplift forces associated with buoyancy.

#### **6.5.1.3 Construction Considerations**

An excavation plan should be prepared in advance of the pump station construction, and be submitted for review by the geotechnical engineer prior to mobilizing equipment to the site.

The plan should be prepared by a qualified registered professional and detail the planned excavation, dewatering, and shoring systems.

We expect that the wet wells and vaults will be constructed by either: sinking the precast cylindrical pump station unit using caisson type construction or by driving continuous sheet pile cut off walls around the excavation and then constructing the pump station within the shored excavation. With either technique, the excavation can likely be made in the wet, a concrete seal poured to stabilize the base of the excavation and resist uplift, and the excavation dewatered by pumping from within the caisson or sheetpile. The seal should be sized to resist buoyancy forces associated with relatively high groundwater levels, as discussed in the previous section of this report and shown on Plate 11. The seal course should be capable of resisting the maximum groundwater level near the excavation, and should be at least 3 feet thick.

Alternatively, the excavation can be dewatered prior to excavation, and the excavation and construction of the pump station can be performed in the dry using cast-in-place concrete. It is our opinion that this type of construction would be relatively difficult because the amount and effectiveness of the dewatering is relatively difficult to assess. The soils encountered at the various sites included loose sand below the groundwater table, and interbedded clay soils that can impede groundwater movement and complicate dewatering. Construction considerations relative to excavation and dewatering considerations are discussed in Section 6.4.13 for the pipeline, and are similar for the planned pump station areas. Where the construction is performed in a dewatered excavation, we recommend that at least 3 feet of stabilizing material consisting of either permeable material, pea-gravel, or drain rock be placed in the base of the excavation. The stabilizing material should be entirely encased in geosynthetic material for stabilization, as recommended in this report.

The project specifications should provide for variation in the soil and groundwater conditions, and for increasing the thickness of the stabilizing material, if needed. Open graded gravel materials placed in the base of the excavation should be compacted to at least 90 percent relative compaction, or be compacted with at least 4 coverages of suitable compaction equipment.

## **6.5.2 Standby Power Buildings**

### **6.5.2.1 Site Preparation and Grading**

Loose dune sand or existing fill materials were typically encountered in the planned standby power building areas. To provide relatively uniform support for foundations and slabs, we recommend that the existing soil in standby power building areas be removed to the recommended depths and be replaced with compacted fill. The excavation should extend to at least 5 feet outside the building footprint. The bottom of the excavation should be graded such that a relatively uniform thickness of fill will be provided below the footings. The recommended minimum depths of removal in the planned building areas are provided in the following table.







Location	Existing Ground Surface	Groundwater Depth Encountered	Estimated Depth of Removal Below the Existing Ground Surface
Baywood & West Paso Standby Power Building at CSD Yard new 8 <sup>th</sup> and El Morro	el. 10 ft.	5	4 feet or 1 foot below the bottom of footings, whichever is deeper. <sup>1</sup>
East Ysabel Standby Power Building and Pump Station at South Bay Boulevard	el. 78 to 83 ft.	22	4 feet or 2 feet below the bottom of footings, whichever is deeper.
East Paso Standby Power Building and Pump Station at 18 <sup>th</sup> Street	el. 71 to 72 ft.	0 to 8 feet	5 feet or 2 feet below the bottom of footings, whichever is deeper <sup>1</sup>
Sunny Oaks Standby Power Building and Pump Station	el. 152 to 159 ft.	About 20	3 feet or 1 foot below the bottom of footings, whichever is deeper
Lupine Standby Power Building and Pump Station at Donna Avenue	el. 14 ft.	4 to 5 feet	5 feet or 1 foot below the bottom of footings, whichever is deeper <sup>1</sup>
Mountain View Standby Power Building at CSD Yard near Nipomo and S. Bay Boulevard.	el. 107 ft.	23 feet	4 feet or 2 foot below the bottom of footings, whichever is deeper

<sup>1</sup> Provide subgrade stabilization to address groundwater or wet soil conditions as recommended below.

**Fill Placement.** Prior to placing compacted fill, the bottom of the excavation should be either stabilized, as discussed below, or be scarified to a depth of approximately 9 inches, moisture conditioned, and compacted in-place to at least 90 percent relative compaction. Fill materials can then be placed to finish grades according to the recommendations of this report. Fill materials placed in the power building area should be compacted to at least 90 percent relative compaction.

**Subgrade Stabilization.** We expect that stabilization of the subgrade will be needed to provide support for the standby power building and stabilize areas of shallow groundwater and wet subgrade conditions. Stabilization should be provided to allow for the recommended compaction to be achieved in the subsequent fill materials. If shallow groundwater or wet subgrade conditions are encountered, at least 2 feet of open graded gravel or permeable material wrapped in a geotextile should be placed in the bottom of the excavation.

Where wet subgrade conditions are encountered, we recommend that the subgrade scarification be omitted and that the gravel be placed on a relatively undisturbed subgrade over the entire building area. Where groundwater is present within the anticipated depth of excavation, dewatering from properly filtered pumps should be provided prior to excavation. The bottom of the excavation should be excavated using construction equipment that will reduce the potential for disturbance of the subgrade, such as an excavator operating outside the limits of the excavation or track mounted equipment with low ground pressures. The geotextile should be then placed over the undisturbed subgrade. The gravel should then be placed over





the geotextile in a single lift. The surface of the gravel should then be compacted to at least 90 percent relative compaction. Where additional fill is to be placed over the gravel, the gravel should be entirely encased in the geotextile.

The project specifications should provide for geotechnical review of the subgrade conditions at the time of excavation, and for increasing gravel thickness, and the depth of excavation, if needed, to remove additional loose or soft material.

#### **6.5.2.2 Foundation and Slab Design**

Footings and slab-on-grade can be designed according the recommendations presented in Sections 6.6 for the treatment plant improvements.





## 6.6 TRI W WASTEWATER TREATMENT PLANT

### 6.6.1 Site Preparation and Grading

Very loose to medium dense dune sand deposits were encountered to various depths at the site. To provide relatively uniform support for foundations and floor slabs, we recommend that the existing dune sand be removed and be replaced as compacted fill. The recommended minimum depths of excavation are based on the depth of the very loose to loose materials encountered in the explorations. The excavations should remove the loose materials, and extend to at least 5 feet beyond the building footprint or perimeter footings and slabs. A summary of the estimated depths of removal follows:

Structure	Approximate FF/Slab Elev.	Recommended Depth of Removal
Operations Building	el. 74.50 feet	el. 65 feet (approximately 10 feet below the existing ground surface) or top of dense sand, whichever is deeper.
Residuals Building	el. 74.00 feet	el. 65 feet (approximately 10 feet below the existing ground surface) or top of dense sand, whichever is deeper.
Influent Pump Station and Plant Drain Pump Station, Septage Tank.	-	Mass grade area in association with Operations and Residual Buildings to at least 5 feet beyond these improvements.
Treatment Building Aeration Basin	el. 67 feet	el. 62 feet (1 to 2 feet below the bottom of the bottom of the footings) (GWT encountered near el. 65 feet in CPT101). Place drain rock encased in geotextile (stabilization) on undisturbed subgrade to base of slab/footing.
Treatment Building - upper level	el. 74 feet	el. 65 feet (approximately 10 feet below the existing ground surface) or top of dense sand, whichever is deeper.
Biofilters	el. 74-75.35 feet	7 feet below the existing ground surface, or 2 feet below the bottom of footings, whichever is deeper.
Treated Effluent Storage/Tertiary Filters	el. 65 feet	2 feet below the bottom of footing, or 10 feet below the existing ground surface whichever is deeper.
Future CSD Office Building	el. 96 feet	5 feet below the existing ground surface, or 2 feet below the bottom of footings, whichever is deeper.
Retention Basin Retaining Wall	el. 65 feet at base of wall	2 feet below the bottom of footing, or 10 feet below the existing ground surface whichever is deeper.
Perimeter SMU Retaining Wall	el. 75 feet at base of wall	2 feet below the base of wall or 5 feet below the existing ground surface whichever is deeper.
Sediment Basin Wall	el. 82 feet at base of wall	2 feet below the base of wall or 7 feet below the existing ground surface whichever is deeper.

Prior to placing compacted fill, the base of the excavation should be scarified to a depth of approximately 9 inches, moisture conditioned, and compacted in-place to at least 95 percent relative compaction. Fill materials placed below footings or floor slabs should be compacted to at least 95 percent relative compaction. Where fill materials are placed as retaining wall or trench backfill that will not support improvements, the backfill should be compacted to at least 90 percent relative compaction. Compacted fill can then be placed to finished grade according to the fill placement recommendations of this report.



### **6.6.2 Foundation Design**

It is our opinion that the proposed improvements can be supported on spread footing foundations bearing in compacted fill materials prepared in accordance with the recommendations of this report. We recommend that for spread footing foundations founded in compacted fill that a maximum allowable bearing pressure of 2,000 pounds per square foot be used for design. Continuous footings should be designed with a width of at least 1 foot. Isolated pad footings should be designed with a least dimension of 1.5 feet. Spread footings should be embedded at least 1 foot into compacted fill material, and at least 1.5 feet below the lowest adjacent exterior grade or finished slab elevation whichever is deeper. The maximum allowable bearing pressure can be increased by 500 pounds per square foot for each additional foot of footing width or embedment exceeding the recommended minimums. The maximum allowable bearing pressure can be increased by one-third when considering short-term wind or seismic loads.

For retaining wall footing design, the maximum toe pressure can be designed to exceed the recommended maximum allowable bearing pressure provided the resultant force acts within the middle third of the footing. The maximum allowable average and toe bearing pressures can be increased by one-third when considering short-term wind or seismic loads.

We estimate that settlements resulting from static foundation loads should generally be on the order of approximately 1-inch total and approximately ½-inch differential between foundation elements designed according to the recommendations of this report.

Reinforcing of foundations should be designed by the structural engineer based on loading conditions. Based on the expected soil conditions, we recommend that at least two Number 4 reinforcing bars be placed in continuous footings, one near the top and one near the bottom.

### **6.6.3 Resistance to Uplift Loads**

We recommend that an unsaturated soil unit weight of 110 pounds per cubic foot be used for areas where soil surcharges will be used to resist uplift forces. We recommend that an effective soil unit weight of 48 pounds per cubic foot be used for soils below the water table. The dead weight of the structure, considering buoyancy forces where they are applicable, can also be used to resist uplift forces.

### **6.6.4 Resistance to Lateral Loads**

Resistance to lateral loading can be provided by sliding friction acting on the base of spread footings or slabs combined with passive pressure acting on the sides of foundations or grade beams. We recommend that a coefficient of friction of 0.4 be used to estimate the sliding resistance along the bottoms of footings or slabs bearing in compacted soil. We recommend that a passive resistance of 350 pounds per cubic foot, equivalent fluid weight, be used to estimate the lateral resistance acting on the sides of footings or grade beams. Passive resistance should not be used for the upper one foot of soil that is not constrained at the ground



surface by slab-on-grade or pavement. A one-third increase in the passive value can be used when considering short-term wind or seismic loads.

#### **6.6.5 Slab-on-grade**

The soils encountered in building areas consist predominantly of sand (SP) to silty sand (SM), and can be considered non-expansive (having an Expansion Index less than 20) for use with the building code. For walkways and other minor flat work that will not be subject to vehicle traffic, we recommend that the upper 12 inches of the subgrade be compacted to at least 90 percent relative compaction.

Slab thickness and reinforcement should be designed by a structural engineer to resist structural loading and to satisfy pertinent code, temperature, and shrinkage requirements. On the basis of the soil conditions encountered, we recommend that concrete floor slabs and flat work without vehicular traffic be at least 4 inches thick and be reinforced with at least No. 3 reinforcing placed at not more than 18 inches on center both ways. Reinforcement should be placed at mid-thickness of the slab and be supported such that the reinforcement will remain in place during construction and concrete placement. Expansion and control joints should be provided in accordance with the Portland Cement Associations guidelines or other applicable design guidelines.

A vapor retarder should be provided below slabs with floor coverings to reduce the potential for moisture to migrate from the soils up to the slab. The vapor retarder should consist of 2 inches of coarse sand, overlain by a visqueen membrane and an additional 2 inches of sand. In lieu of the vapor barrier, we recommend that slabs with vehicle traffic be underlain by at least 4 inches of aggregate base over 4 inches of drainage material compacted to at least 95 percent relative compaction. Sand, aggregate base, and drainage materials should conform to the suggested materials specifications of this report.

#### **6.6.6 Earth Retaining Structures**

Site retaining walls and below grade structures can be designed to resist lateral earth pressures according to the recommendations of this section. Buried cylindrical structures such as drywells and wet wells associated with pump stations can be designed according to the recommendations presented in Section 6.5.1.1 for the pump station design.

Retaining wall backfill material should be compacted to at least 90 percent relative compaction, unless a higher degree of compaction is otherwise recommended, such as in building or pavement areas. Our recommended equivalent fluid weights presented below are for conditions where the backfill material is placed level behind retaining walls. Backfill material for retaining structures should consist of Retaining Wall Backfill material conforming to the suggested material specifications of this report. The tabulated values presented below are based on a soil unit weight of 125 pounds per cubic foot (pcf). We recommend that the following lateral earth pressures (equivalent fluid weights) be used for the design of retaining walls:





### Static Lateral Earth Pressures

Wall Loading Condition	Lateral Earth Pressure Condition	Equivalent Fluid Weight (pcf)
Free Standing	Active - Drained	38
	Active - Submerged	19 + water pressure
Braced	At-rest - Drained	60
	At-rest - Submerged	30 + water pressure

**Wall Drainage.** The values for drained backfill conditions do not provide for hydrostatic forces (for example, standing water in the backfill materials). We recommend that drainage be provided behind retaining walls when designing using earth pressure conditions corresponding "drained backfill conditions" to reduce the potential for water to accumulate within the backfill. Drainage should consist of placing at least a 1-foot thick layer drainage material immediately behind the wall. As an alternative, drainage material can consist of prefabricated geocomposite drainage panels. Drainage and Geocomposite Drain materials should conform to the suggested materials specifications of this report.

**Surcharges.** The recommended equivalent fluid weights do not account for surcharge loads acting on the backfill. The surcharge from foundation loads can be neglected, provided adjacent footings are setback behind a 1:1 line projected upward from the base of the wall. The lateral earth pressure from uniform surcharge loads can be estimated as 0.3 times the stress being applied at the ground surface. Traffic surcharges can be estimated as an additional 2 feet of soil cover, equal to a uniform pressure of 72 pounds per square foot. Fugro should provide additional recommendations if foundation loads act within the 1:1 line, or other surcharges to retaining walls are anticipated.





### 6.6.7 Dynamic Earth Pressures

Retaining walls (restrained and unrestrained) can be designed using pseudostatic analyses based on the Mononobe Okabe approach (Whitman 1990, Wood 1973). The dynamic earth pressure that should be considered in the pseudostatic analyses is dependent on the anticipated ground motions at the site and the stiffness of the wall retaining the soil. We estimated dynamic earth pressures using the Mononobe Okabe method and assuming a horizontal ground acceleration of 0.4g (design-basis acceleration).

The seismic increment of lateral earth pressure is relative to whether or not the wall is designed for at-rest or active conditions, and the ability of the wall to tolerate deformation or yielding during an earthquake. The lateral deformation of retaining structures was estimated considering the design-basis earthquake and using procedures proposed by Richard and Elms (1979). The estimated deformations assume that the walls were designed for static loads, have a factor of safety of at least 1.5 against sliding under the static load, are free to tolerate the estimated deformations, and that the backfill material does not liquefy during the earthquake. In considering the estimated deformations, the retaining wall should also be checked for overturning based on the recommended dynamic earth pressures presented for using pseudostatic analysis.

The following table summarizes our estimated dynamic earth pressure in terms of an equivalent fluid weight. Dynamic earth pressures will reduce if the deflection at the top of the wall can exceed 0.001 times the height of the wall (H). If the wall can tolerate this amount deformation, then the dynamic earth pressure on the wall can be estimated using the equivalent fluid weights presented in the following table, and corresponding to the estimated lateral deflection. The dynamic earth pressures are the total dynamic lateral earth pressure estimated for pseudostatic loading, and not the "seismic increment" that is relative to the static earth pressure that the wall is designed for. If a wall is non-yielding under the estimated seismic load, the estimated lateral earth pressure on the wall will be significantly greater.

The estimated resulting force corresponding to the dynamic earth pressure ( $P_{AE}$ ) resulting from seismic loads acting on braced walls can be estimated as  $P_{AE} = \frac{1}{2} \times$  equivalent fluid weight  $\times H^2$ , in pounds force per lineal foot of wall. The dynamic pressure on the wall can be estimated as an inverted triangular pressure distribution with the resultant force acting  $\frac{2}{3}H$  above the base of the wall. The lateral earth pressure on a wall having a submerged backfill is the combined lateral earth and hydrodynamic pressures.

**Dynamic Lateral Earth Pressure**

Wall Loading Condition	Lateral Earth Pressure Condition	Total Dynamic Earth Pressure (pcf)	Estimated Deflection (inches)
Free Standing	Active - Drained	54	$\frac{1}{2}$ "
Constrained	At-rest - Drained	54	$\frac{1}{2}$ "
Non-Yielding	At-rest - Drained	120	"0"





**Dynamic Lateral Earth and Hydrodynamic Pressure with  
Submerged Backfill without Liquefaction**

Wall Loading Condition	Lateral Earth Pressure Condition	Total Dynamic Earth Pressure (pcf)	Combined Hydrodynamic and Static earth Pressure (pcf)	Estimated Deflection (inches)
Free Standing	Active	27	92	1/2"
Constrained	At-rest	27	92	1/4"
Non-Yielding	At-rest	60	92	"0"





### **6.6.8 Segmental Masonry Unit (SMU) Retaining Walls**

It is our understanding that segmental masonry unit (SMU) retaining walls are to be used in the area surrounding the Tri-W Wastewater Treatment Plant facility. The approximate limits of the retaining walls are shown on Plate 2b. Design retaining wall heights range from approximately 5 to 23 feet. The batter on the face of the retaining walls will be 1h:8v, which equates to 1-inch of offset for an 8-inch high masonry unit. A typical detail showing the minimum wall embedment and reinforcement for typical SMU retaining wall heights is presented on Plate 12a. The soils beneath the retaining wall foundation should be prepared according to the site preparation and grading recommendations of this report.

The SMU wall is likely to consist of a proprietary wall system provided to the contractor that should be checked for compliance with the geotechnical recommendations of this report. Prior to mobilizing materials and equipment for the wall's construction, we recommend that the contractor prepare shop drawings and supporting technical data for the selected SMU system. The shop drawings should be reviewed by the geotechnical engineer for general conformance with the recommendations provided in this report and assumptions made during our analyses.

#### **6.6.8.1 Geosynthetic Reinforcement and Facing**

Geosynthetic reinforcement and compacted fill should comply with the recommendations for Geosynthetic Reinforcement and Retaining Wall Backfill, as summarized in the suggested material specifications section of this report. We have recommended the number of reinforcing layers, vertical spacing, and long-term design strengths (LTDS) for the geosynthetic reinforcement based on the results of the slope stability evaluation. Based on those results, SMU retaining walls greater than 5 feet in height should be reinforced with geosynthetic. Typically, SMU wall heights less than 5 feet can be designed without reinforcements. The contractor should provide a submittal prepared by the manufacturer that shows that the wall can be unreinforced, or the shorter wall can be designed according to the typical detail for walls that are less than 10 feet in height as shown on Plate 12a.

Masonry facing units used in the wall designs should support the soil materials between layers of reinforcement and be anchored to the reinforcement. Based on the maximum 4-foot vertical spacing between reinforcements, the facing between the reinforcement should be designed to support a uniform lateral earth pressure of 150 psf. The connection between the masonry units and the geosynthetic reinforcement should have a pullout strength of at least 600 pounds per lineal foot of wall. The estimated lateral earth pressure and pullout strength include a factor of safety of 1.5.

Where the masonry units will have voids or gaps, pea gravel can be used to fill the voids and provide support for adjacent blocks. A filter fabric should be provided between the sandy retaining wall backfill and the gravel and/or blocks to prevent the migration of material through the wall.

The facing elements should be initiated from a leveling pad consisting of either lean concrete or compacted aggregate base. Aggregate base should be at least 6 inches thick and



be compacted to at least 95 percent relative compaction. Further, the leveling pad should extend at least 6 inches out from the toe and heel of the lowermost masonry unit. The leveling pad materials should be specified in the shop drawings.

#### **6.6.8.2 Placement of Reinforcement**

Geosynthetic reinforcement should be laid horizontally on a relatively flat surface, without wrinkles, and oriented with the design strength of the reinforcement perpendicular to the retaining wall face. Overlaps and splices of the geosynthetic reinforcement in the design strength direction should not be permitted. If an overlap is required, adjacent rolls of reinforcing should be provided in accordance with the manufacturer's recommendations and should be separated with at least 3-inches of wall backfill material. Geosynthetic reinforcement should be continuous throughout the wall length. If permitted by the manufacturer, geosynthetic reinforcement behind curved wall sections with concave corners may be placed without overlap and with gaps for a specified elevation. However, geosynthetic reinforcement for the next specified elevation above should be located in a manner that covers gaps left by the previous layer of reinforcement.

Retaining wall backfill between and behind the geosynthetic reinforcing should be placed according to the recommendations provided in this report and should be compacted to at least 90 percent relative compaction. During spreading and compacting, at least 6 inches of soil, measured vertically, should be maintained between the geosynthetic reinforcement and the construction equipment and/or be placed according to the manufacturers specifications. Fill should be placed, spread, and compacted in such a manner that prevents the development of wrinkles and/or movement of the geosynthetic reinforcement. Equipment or vehicles should not be operated or driven directly on the geosynthetic reinforcement, unless specifically allowed by the manufacturer and documented with supporting data. Compaction and fill placement near the retaining wall face should be performed to limit the deformation of the face to less than plus or minus 1 percent within each lift, vertically, and plus or minus 1 percent in 10 feet, horizontally.

#### **6.6.8.3 Wall Drainage and Backfill**

Backfill materials placed between the face of the SMU and the temporary construction slope behind the wall should consist of retaining wall backfill material complying to the recommendations of this report, and be compacted to at least 90 percent relative compaction, unless a higher degree of compaction is otherwise recommended. Surface drainage should be provided such that surface water does not run over the face of the wall or pond on the backfill. As illustrated on Plate 12a, a geo-composite drain panel with collector pipe should be installed behind the geosynthetic reinforcing to a depth corresponding to finish grade. The geocomposite drain should be connected to a collection pipe and outlet to a storm drain or drainage area.



## **6.6.9 Sedimentation Basin Geosynthetic Reinforced Slope**

The location of the sedimentation basin is illustrated on Plate 2b. The slopes of the basin are designed to be approximately 8 feet high and inclined at 1.5h:1v. The faces of the basin slopes are to be dressed with architectural boulders with nominal diameters ranging between 1 and 3 feet. The soils beneath the sedimentation basin slopes should be prepared according to the site preparation and grading recommendations of this report.

### **6.6.9.1 Geosynthetic Reinforcement and Spacing**

Based on the results of our slope stability analyses, the sedimentation basin slopes should be reinforced with geosynthetic reinforcing to provide support for the 1.5h:1v slope. A typical detail for the design of sedimentation basin slopes is presented on Plate 12b – Typical Detail for Sedimentation Basin Slopes. We recommended the number of reinforcing layers, vertical spacing, and long-term design strengths (LTDS) for the geosynthetic reinforcement based on the results of our slope stability evaluation.

As noted, the first layer of geosynthetic reinforcing should be placed at an elevation corresponding to the finish grade elevation of the sedimentation basin. Geosynthetic reinforcement and compacted fill used in the construction of the sedimentation basin slopes should comply with the recommendations for geosynthetic reinforcement and retaining wall backfill, as summarized in the suggested material specifications section of this report.

Geosynthetic reinforcement should be laid horizontally on a relatively flat surface, without wrinkles, and oriented with the design strength of the reinforcement perpendicular to the slope face as discussed in the previous section of this report for the SMU wall design. Layers of geosynthetic reinforcing should be continuous throughout the slope length and should be wrapped at the face. Vertically adjacent layers of reinforcement should be overlapped at least 3 feet behind the face with the overlapping layers of reinforcement separated with at least 3 inches of backfill material behind the slope face.

### **6.6.9.2 Slope Drainage and Backfill**

Backfill materials placed between the face of the slope and the temporary construction slope behind the reinforced slope should consist of retaining wall backfill material complying to the recommendations of this report, and be compacted to at least 90 percent relative compaction, unless a higher degree of compaction is otherwise recommended. A layer of gravel drainage material encased in filter fabric should be placed within the geosynthetic reinforcement for each fill layer, as illustrated on Plate 12b. A minimum of 1 cubic foot of drainage material should be used per square foot of slope face. Drainage material and filter fabric should comply with the recommendations provided in the suggested material specifications of this report.





### **6.6.9.3 Boulder Facing**

A toe key at least 2 feet deep and 4 feet wide should be excavated at the toe of the slope to provide support for the boulder facing. Alternatively, a reinforced concrete key may be located at the toe of the slope at finish grade to provide this support. Such a key should be designed to provide a lateral resistance of at least 600 pounds per foot of slope length.

Boulder facing should be initiated from within the toe key at the base of the slope, and placed progressing from the bottom to top of slope. The boulders should be placed and keyed individually to provide relatively tight and interlocking support for each unit. The boulders should be placed such that the slope and exposed geosynthetic reinforcing are completely covered.





## **6.6.10 Basin Design**

### **6.6.10.1 Slope Design**

Sedimentation, detention, and percolation ponds are planned as part of the treatment plant design. We understand from MWH that the slopes for the storage ponds will likely be unlined. We recommend that the basin slopes be designed at inclinations of 4h:1v or flatter. Cut and fill slopes outside the basin areas should be designed no steeper than 2.5h:1v. If erosion control is provided, such as permanent erosion control matting with suitable vegetation, slopes can be designed at 2.5h:1v or flatter.

The slopes will be excavated in sandy materials that are subject to erosion. Ongoing maintenance of the slopes will likely be needed to repair erosion and assist in establishing vegetation on the slopes.

Retaining walls to support portions of the basin slopes should be designed according to the recommendations presented in Section 6.6.6 of this report.

### **6.6.10.2 Percolation**

Percolation and double ring infiltrometer testing was performed for the design of the percolation basin, as presented in Sections 3.6.1 and 3.6.2 of this report. The basin will be turfed and serve dual-use as playing fields and to allow storm water to infiltrate the ground surface. MWH (2002) states that the basin is designed based on an assumed percolation rate of 5 minutes per inch. The basin will be excavated to 1 to 10 feet below the existing ground surface.

The soils encountered within the percolation basin area are generally loose to medium dense fine dune sand. Percolation testing performed at the site and surrounding areas indicate that the dune sand has a percolation rate typically less than 1 minute per inch. Double ring-infiltrometer testing was performed at the Sea Pines golf course and Tri-W site to evaluate the influence that an established turf has on percolation. Results of test performed at the golf course were typically similar to those performed immediately below the turf. Although selected shallow tests (less than 1 foot) performed at Sea Pines and Tri-W were typically slower than percolation tests performed at 5 feet below the existing ground surface, the results for tests performed on and below the turf were similar.

A factor that appears to influence the percolation of the shallow test results is that the near surface soils within the Los Osos area are hydrophobic. Water will typically runoff or percolate slowly into the near surface hydrophobic soils. The hydrophobic soils are associated with the topsoil development, and are not expected to significantly influence the percolation basin. However, where the depth of the basin is shallower than 2 feet, we recommend that the existing topsoil be stripped to a depth of at least 2 feet below the existing ground surface. Turf and on-site sandy soil can then be placed to finish grades. An underdrain type system below the playing fields would likely help to enhance percolation through the new turf.





Silt, clay, or peat moss that may cause a barrier to percolation should not be used in the design of the turf. Periodic maintenance to remove silt and storm deposited sediment, and to aerate the turf, will improve percolation.



## **6.6.11 Pavement Design**

### **6.6.11.1 Subgrade Preparation**

We understand that asphalt pavements are planned for entrance driveway improvements, and Portland cement concrete pavements are planned for the septage receiving stations. To provide relatively uniform support for pavements, we recommend that the existing soils be removed to a depth of at least 2 feet below the existing ground surface, or to the bottom of the pavement section, whichever is deeper. In cut areas where the bottom of the structural section is 2 feet or more below the existing ground surface, we recommend that the upper 1-foot of the subgrade, as measured below the bottom of aggregate base, be compacted to at least 95 percent relative compaction. Fill materials placed within 3 feet of finish grade should be compacted to at least 95 percent relative compaction. Embankment fill placed more than 3 feet below finished grade should be compacted to at least 90 percent relative compaction.

We recommend that the subgrade materials be reviewed at the time of construction with regard to the as-graded conditions. On the basis of our observations and tests, we can provide additional pavement section recommendations at that time, if needed. Where lower R-value material or wet soils are encountered in subgrade areas, thicker pavement sections may be needed. The project specifications should provide for variations in the subgrade conditions, and resulting increased thickness in the pavement section.

### **6.6.11.2 Asphalt Pavements**

Asphalt concrete pavements for driveways and parking areas can be designed according to the recommendations of Section 6.4.8, provided for pavement replacement in the pipeline trench areas.

### **6.6.11.3 Portland Cement Concrete Pavements**

Where Portland cement concrete is used for pavements, such as the septage receiving stations, the concrete should have a compressive strength of at least 4,000 pounds per square inch at 28 days. Based on the expected traffic loading, we recommend that concrete pavements subject to vehicle traffic be designed with a minimum thickness of 8 inches in truck traffic areas, and at least 6 inches thick where the access will be limited to passenger cars and pick-up trucks. Concrete pavements should be cast on a subgrade prepared in accordance with Section 6.6.11.1, and should be underlain with at least 4 inches of aggregate base compacted to at least 95 percent relative compaction.

## **6.6.12 Utility Trenches**

Excavation of utility trenches can likely be accomplished with a backhoe. Trenches over 5 feet in depth should be braced or sloped in accordance with the requirements of (Cal) OSHA. Considerations for the design of temporary slopes and shoring systems are discussed in Sections 6.4.13.3 and 6.4.13.4 of this report. Placement of utility trench backfill should be performed according to the recommendations of this report relating to minimum compaction





recommendations. Where utility lines penetrate perimeter foundations or planter footings, a cut-off should be provided to reduce the potential for water movement below the slabs and pavements. Where the utility must pass through the foundation, the footing should be stepped down below the pipe such that the utility is fully surrounded by concrete. In general, backfill for service lines extending inside of the project area should be compacted to at least 90 percent relative compaction, or to 95 percent relative compaction in building and pavement areas.

#### **6.6.13 Drainage Considerations**

Site grading and drainage swales should be provided such that positive drainage away from foundations and slabs is provided. Water should not be allowed to pond near the structures, pavements or run over slopes. We recommend that roof gutters or drainage systems be installed to collect roof water and to carry the water away from the foundations. In planter areas, deepened curb edges or moisture retarders should be provided to reduce the potential for irrigation water to infiltrate subgrade soils below slabs and pavements.

#### **6.6.14 Erosion**

The soils encountered at the site generally consist of fine sand that is very susceptible to erosion. Erosion control measures, such as hydro-seeding, erosion control matting, and maintenance, should be provided to reduce the potential for erosion while vegetation is being established on slopes. On-going maintenance of the slopes should be provided, as-needed, to assist in establishing appropriate vegetation and to repair erosion that occurs. Energy dissipation and erosion control devices should be provided at outlets of drainage pipes and in areas where there are concentrated flows of runoff to reduce the potential for erosion.

#### **6.6.15 Groundwater Considerations**

Groundwater was encountered near el. 50 feet during an October 2000 (CFS 2000a) field exploration program, near the 1997 water levels shown on Plate 6b. Extrapolating between explorations, the water level below the main plant site was encountered near elevation 60 to 65 feet, as shown on Plate 7a. Based on the potential for groundwater to rise near the finish grades of the plant, we recommend that a layer of drainage material be provided below the floor slabs of the various tanks and structures. At least 6 inches of permeable material conforming to the recommendations of this report should be provided below slabs to intercept groundwater and reduce the potential for uplift pressure to develop below sealed structures. Collector pipes should be placed one way at no more than 10-foot on-center below the permeable layer, and be embedded in at least 1 cubic foot of permeable material for each foot of pipe. The collector pipe should outlet downslope of the plant, and in an area that will not be submerged. The piping for the collection system should be equipped with vents and cleanouts to allow for maintenance of the underdrain system.





## 6.7 EFFLUENT DISPOSAL SYSTEM DESIGN

The EPA (1981) guidelines suggest that infiltration rates for effluent disposal basins should not exceed approximately 10 to 15 percent of the measured field infiltration rates. As a basis for recommending suitable application rates for the design of the effluent system, we have recommended allowable application rates for the design of percolation lines and drywells based on 1/6 of the estimated infiltration rate of the soil estimated from the prototype percolation line and drywell test results previously discussed in this report.

### 6.7.1 Percolation Lines

Percolation lines will be used to dispose of approximately 800,000 gallons per day of treated effluent at the Broderson site. Percolation lines can be designed using methods and protocols similar to those used to design and install leach lines for residential septage disposal systems. Relatively well-drained dune sand deposits were encountered at the Broderson site. Percolation testing and permeability testing performed for the Broderson site indicate that the soils tested had percolation rates of typically less than 1 minute per inch, and a permeability of at least 0.001 cm/second or faster. Prototype testing was also performed at the site to estimate the infiltration capacity of the dune sand, as discussed in Section 3.6.2 of this report. An ultimate infiltration rate of 180 gpd/ft<sup>2</sup> through the wetted surface area of the trench was observed during the prototype testing. It is our opinion that the Broderson site is geotechnically suitable for the proposed disposal of effluent using buried percolation lines.

#### 6.7.1.1 Percolation Trench Design

We recommend that percolation lines be designed using an allowable application rate of 30 gpd/ft<sup>2</sup>. A detail summarizing our recommendations for the design of percolation trenches is shown on Plate 13a. The length (L) of individual percolation lines should be limited to 100 lineal feet or less. The bottom of the trenches should be excavated into relatively undisturbed dune sand, and extend to at least 5 feet below the existing ground surface. The trenches should be excavated to a width (W) of at least 3 feet, and provide for at least a 12-inch depth (D) of gravel below a 4-inch exfiltration pipe. The pipe should be laid level and covered with at least 2 inches of gravel. The gravel should be covered with a layer of needle punched geotextile and at least 12 inches of earth. The effective infiltration area of the trench can be estimated as the combined bottom area and one-half of the sidewall area below the pipe. The maximum allowable flow into the trench can then be estimated as 30 gpd/ft<sup>2</sup> x (W x L + ½ B x D), with the trench dimensions in feet. A 10-foot clear spacing should be provided between percolation line trenches.

Gravel for the percolation lines should be 1.5-inch Drain Rock complying with the suggested material specifications of this report. Prior to being placed in the trench, the gravel should be stockpiled at the site, and be sluiced with water to remove fines and dirt from the aggregate.

### **6.7.1.2 Construction Considerations**

A 50-foot long prototype percolation line was installed at the Broderson site for this project as discussed in Section 3.6.3.1 of this report. Various test trenches were also excavated within the project area as discussed in Sections 3.4.4 and 6.4.13.1 of this report. The trench for the prototype percolation line was approximately 3 feet wide and extended to 5 to 7 feet below the existing ground surface. The trench excavation and gravel placement was performed in about 10-foot long segments to avoid caving of the sidewalls. Essentially no caving or sloughing of the sidewalls was observed during the construction of the test line.

The potential for caving in the dune sand will generally increase with depth, and length of the trench. It is our opinion that there is a potential for sloughing and caving of the trench sidewalls. Limiting the length of trench or installing temporary trench supports can be used to reduce the potential for caving. Trench shields or jacked shoring with plywood sheeting can be installed to support the trench walls during the placement of the gravel and pipe.

### **6.7.2 Drywells**

Drywells will be used to dispose of approximately 160,000 gallons per day per site of treated effluent at each: the Pismo Site and the Santa Maria site. Drywells can be designed using methods and protocols similar to those used to design and install drywells lines for residential septage disposal systems. Relatively well-drained dune sand deposits were encountered below the Pismo and Santa Maria sites. Percolation testing and permeability testing performed for the Broderson site indicate that the soils tested had percolation rates of typically less than 1 minute per inch, and a permeability of at least 0.001 cm/second or faster. Prototype drywell testing was also performed at the Santa Maria site to estimate the infiltration capacity of the dune sand, as discussed in Section 3.6.4 of this report. An ultimate infiltration rate of 500 gpd/ft<sup>2</sup> through the wetted surface area of the drywell was observed during the prototype testing. It is our opinion that the Pismo and Santa Maria sites are geotechnically suitable for disposal of the treated using drywells.

#### **6.7.2.1 Drywell Design**

We recommend that drywells be designed using an allowable application rate of 80 gpd/ft<sup>2</sup>. A detail summarizing our recommendations for the design of drywells is shown on Plate 13b. Drywells should be drilled into relatively undisturbed dune sand, and extend to at least 25 feet below the existing ground surface. A vertical slotted pipe and gravel should be placed in the hole, and a 5-foot thick concrete surface seal should be provided above the gravel. A layer of visqueen should be placed over the gravel prior to placing the concrete surface seal.

The drywells should have a diameter (B) of at least 4 feet, and have a depth of gravel (D) of at least a 20-feet below the surface seal. The pipe should be placed near vertical (inclined no more than  $\pm 2$  percent the length of the pipe) near the center of the well, with a solid riser provided in the upper 10 feet of the well. The effective infiltration area of a drywell can be estimated based on the sidewall area below the surface seal and should provide for at least 5 feet of freeboard between the bottom of the seal and the design water level in the drywell.



The maximum allowable flow into the drywell can then be estimated as  $80 \text{ gpd/ft}^2 \times 3.14 \times B \times (D-5)$ , with the drywell dimensions in feet.

Gravel for the drywells should be 3/8-inch Drain Rock complying with the suggested material specifications of this report. The distribution pipe should be a 4-inch diameter slotted pipe, having a slot width of 0.08 inches. Prior to being placed in the trench, the gravel should be stockpiled at the site, and be sluiced with water to remove fines and dirt from the aggregate.

#### **6.7.2.2 Construction Considerations**

The construction of a prototype drywell installed at the Santa Maria site was previously discussed in this report. The Santa Maria and Pismo Sites are generally underlain by medium to very dense dune sand. The excavation for the prototype drywell was 4 feet in diameter and was drilled to approximately 25 feet below ground surface without the use of casing. However, the relative density of the dune sand and soil moisture conditions vary between sites and our explorations. We therefore recommend that the contractor be prepared to install temporary casings to assist in the drywell excavation and gravel placement. The use of drilling mud, slurries, or other fluid stabilizers should not be permitted for use in drywell construction on this project.

If caving occurs and temporary casings are used to support the borehole walls during excavation, the casing should be withdrawn as the gravel is being placed. The gravel should be placed through the casing as the casing is withdrawn from the excavation. The depth of the gravel should be maintained at least 3 feet above the bottom of the the casing during the casing's removal.

#### **6.7.3 Expansion Areas**

We recommend that expansion areas for the effluent disposal system be identified and be available as part of the design of the effluent disposal system. The purpose of the expansion area is to allow for future expansion and/or replacement of percolation lines and drywells, if needed. Replacement could be needed if infiltration rates reduce during the long-term operation, or components of the systems become clogged due to biological fowling. Replacement systems should generally not overlap with existing systems. The expansion area should provide for at least a 100 percent expansion in the disposal system. The expansion area can provide for expansion of percolation lines, drywells, or a combination of both. The expansion areas can be accommodated within existing, or separate, designated sites.

#### **6.7.4 Hydrogeologic Considerations**

Hydrogeologic evaluations and groundwater studies for the effluent disposal sites are being performed by Cleath and Associates. Monitoring wells and hydroprobe data were used to assist in monitoring the testing of the prototype percolation lines and drywells, as discussed in this report. We understand that monitoring wells have been and will be installed at the effluent disposal sites to provide for post-construction monitoring of the systems relative to mounding, the influence of perching layers within the subsurface, and that the design application rates are





suitable for the site conditions. The results of the prototype testing should be reviewed relative to the hydrogeologic evaluation of the site and mounding estimates. Perching of groundwater below the test areas was observed at both the percolation line test site at Broderson and at the drywell site on Santa Maria Avenue. The perching mainly was observed along boundaries of soil units of differing relative density and age.

#### **6.7.5 Operation and Post-Construction Monitoring**

The operation of the system should allow for resting to allow for periodic aeration of the soil. Observation ports should be installed within the percolation trenches as indicated on Plate 31a to allow for monitoring of water levels in the trench during effluent disposal.

Observation of the effluent will allow for application rates to the percolation lines and drywells to be further evaluated under actual, long-term operating conditions, and for adjustments in the application rates during the operation of the system. Flows and water levels within the trenches and drywells should be documented and logged as part of the operation of the system.





## 7. CONTINUATION OF SERVICES

The geotechnical evaluation consists of an ongoing process involving the planning, design, and construction phases of the project. To provide this continued service, we recommend that the geotechnical engineer be provided the opportunity to review the project plans and specifications, and observe portions of the site grading and fill placement during construction.

Subsurface conditions, excavations and fill placement should be reviewed by the geotechnical engineer during construction to evaluate if the subsurface conditions encountered and construction methods are consistent with those assumed for design. The geotechnical professional should also review the project plans and specifications prior to construction. The purpose of the review is to evaluate if the plans and specifications were prepared in general accordance with the recommendations of this report.



## 8. REFERENCES

- Asquith, D.O. (1997), "Review of Potentially Problematic Faults in San Luis Obispo County", Prepared for Fugro West, Inc., and the County of San Luis Obispo, January 28.
- Blake, T.F. (2000). "FRISKSP - A computer program for the probabilistic estimation of peak acceleration and uniform hazard spectra using 3-D faults as earthquake sources." Windows Version 4.0.
- Boore, D.M., Joyner, W.B., and Fumal, T.E. (1997). "Equations for Estimating Horizontal Response Spectra and Peak Acceleration from Western North American Earthquakes: A Summary of Recent Work." *Seismological Research Letters*, Volume 68, Number 1, Seismological Society of America.
- California Department of Water Resources (1989), "Geohydrology and Management of Los Osos Valley Groundwater Basin, San Luis Obispo County", District Report, July.
- California Building Code (2001). California Code of Regulations, Title 24, Part 2, Volume 2, California Building Standards Commission.
- California Division of Mines and Geology (1996). "California Fault Parameters." *CDMG Open File Report No. 96-08*, Sacramento, California.
- California Division of Mines and Geology (1997), Guidelines for Evaluating and Mitigating Seismic Hazards in California, Special Publication 117.
- CFS Geotechnical Consultants (2000a), "DRAFT - Geotechnical Report, Los Osos Wastewater Project, Los Osos, California", unpublished consultant report, prepared for Los Osos Community Services District, dated June 19.
- CFS Geotechnical Consultants (2000a), various CPT and Borings Logs that were not submitted for "Los Osos Wastewater Project, Los Osos, California", unpublished consultant report, prepared for Los Osos Community Services District, dated June 19.
- CFS Geotechnical Consultants (2000b), Handout summarizing preliminary results of I. Liquefaction Evaluation, and II. Review of Trenching Conditions, for LOCSD Board, October 24.
- Cleath & Associates (2000), "Hydrogeologic Investigation of The Broderson Site, Phase 2 - Impacts Assessment", unpublished consultant report prepared for Los Osos Community Services District, November.
- Cleath & Associates (2003a), "Los Osos Nitrate Monitoring Program, February-March 2003 Groundwater Monitoring", unpublished consultant report prepared for Los Osos Community Services District, May, p. 3





- Cleath & Associates (2003b), "Geologic Structure of the Los Osos Valley Ground Water Basin", unpublished consultant report prepared for Los Osos Community Services District, November, boring logs and selected maps and text.
- Cleath & Associates (2003c), Fax Transmittal from Spencer Harris regarding: Former Strand B, 17 pages, received December 8.
- Elms, D.G. and Richards, R. (1990), "Seismic Design of Retaining Walls", Proceedings: *Design and Performance of Earth Retaining Structures*, edited by P.C. Lambe and L.A. Hansen, ASCE Geotechnical Special Publication No. 25, pp. 854-871.
- Engineering Development Associates and The Morro Group, Inc. (1997), "Preliminary Drainage Evaluation, Los Osos/Baywood Park Community Drainage Project for San Luis Obispo County Area No. 9J", Working Paper No. 2, February 27.
- Environmental Protection Agency, United States (1981), *Process Design Manual for Land Treatment of Municipal Waste Water*, EPA 625/1-81-013 (COE EM1110-1-501), published by U.S. Environmental Protection Agency Center for Environmental Research Information, Cincinnati, pp. 5-15 to 5-19.
- Fugro West, Inc. (1996a), "Revised Report on Limited Geotechnical Engineering Services, Los Osos Sewer Recharge Site, San Luis Obispo, California", Project No. 95-92-4281, February 9.
- Fugro West, Inc. (1996b), "Los Osos Sewer Alternative Treatment Facility Sites, Constraints Study", prepared for County of San Luis Obispo, Engineering Department, Project No. 95-61-4282, June 13.
- Fugro West, Inc. (1997), "Draft Geotechnical Engineering Report, Los Osos Wastewater Project, San Luis Obispo, California", unpublished prepared for County of San Luis Obispo, Engineering Department, April 5.
- Hall, C.A. (1973), "Geologic Map of the Morro Bay South and Port San Luis Quadrangles, San Luis Obispo County, California," Map MF-511.
- Hartley, J.D. and Duncan, J.M. (1987), "E' and Its Variations with Depth", *ASCE Journal of Transportation Engineering*, Vol. 113, No. 5, September.
- Houston, J.R., and Garcia, A.W. (1978), Type 16 Flood Insurance Study: Tsunami Predictions for the West Coast of the Continental United States: U.S. Army Engineer Waterways Experiment Station Hydraulics Laboratory, P.O. Box 631, Vicksburg, Mississippi, 39180.
- Idriss, I.M. (1993). "Procedures for Selecting Earthquake Ground Motions at Rock Sites." *National Institute of Standards and Technology NIST GCR 93-625*, Gaithersburg, Maryland, March.





- Kilbourne, R.T., and Mualchin, L. (1980), *Geology for Planning, Cayucos and Cypress Mountain 7 1/2 -Minute Quadrangles, San Luis Obispo County, California*, California Division of Mines and Geology Open-File Report 80-6 SF, 48 p. with Plates.
- Lettis, W.R. and Hall, N.T. (1990), "The Los Osos Fault Zone, San Luis Obispo County, California" in *Neotectonics of the South-Central Coastal California*, Friends of the Pleistocene 1990 Fall Field Trip Guidebook, September 21-23, p. 299-347.
- McGuire, R.K. (1978). "FRISK - Computer program for seismic risk analysis using faults as earthquake sources." *Open File Report No. 78-1007*, United States Geological Survey (USGS), Reston, Virginia.
- Metcalf & Eddy, Inc. (1995), *Logs for Boring Nos. 1 through 14, Drilled by S/G Testing Laboratories for M&E between October 25 and November 1.*
- Metcalf & Eddy, Inc. (1996a), "Hydrogeologic Evaluation of the Proposed Broderson Recharge Site, Los Osos, California", unpublished consultant report prepared for San Luis Obispo County Engineering Department,
- Metcalf & Eddy, Inc. (1996b), "Draft - Los Osos Water Reclamation Project, Technical Memoranda for Alternative Site Evaluation, Alternative Treatment Process Evaluation, Alternative Collection System Evaluation, Alternative Pump Station Evaluation", prepared for County Service Area No. 9, unpublished consultant report prepared for County Engineering Department, County of San Luis Obispo, June 14.
- Metcalf & Eddy, Inc. (1997), "Draft - Evaluation of Effluent Disposal at the Proposed Broderson Recharge Site, Los Osos, California", unpublished consultant report prepared for County of San Luis Obispo, San Luis Obispo, California, November 21.
- Miller Pipeline Corporation (2003), fax transmittals dated September 8 and 9 summarizing utility potholing information and pavement structural sections.
- Montgomery Watson Harza (2001), "Wastewater Facility Project, Final Project Report, Executive Summary" prepared for Los Osos CSD, dated March 7.
- Montgomery Watson Harza (2002), "Los Osos Wastewater System, WWTF Drainage Report", unpublished consultant report prepared for Los Osos CSD, dated April 22.
- Montgomery Watson Harza (2002), "Los Osos Wastewater Project, Technical Memorandum", prepared for Los Osos CSD, dated December 16.
- Montgomery Watson Harza (2003a), "Los Osos Wastewater Project, Pump Stations, Standby Power, Wells, and Effluent Disposal System, Areas A and D, Areas B and C", 90% Submittal of Plans and Specifications, November.
- Montgomery Watson Harza (2003b), "Los Osos WWTP, Grading Plan", Sheet 1, January 15.





- Montgomery Watson Harza (2003c), MS PowerPoint Graphic provided for "Collection System – Sewer Mains, Pump Stations and Force Mains, Effluent Disposal System, and Harvest well System", via email from Steve Hyland on December 16.
- P.G. & E. (Pacific Gas & Electric) (1988), "Final Report of the Diablo Canyon Long-Term Seismic Program", U.S. Nuclear Regulatory Commission Docket Nos. 50-275 and 50-323.
- Richards, R. and Elms, D.G. (1979), "Seismic Behavior of Gravity Retaining Walls", ASCE Journal of Geotechnical Engineering, Vol. 105, No. 4, April, pp. 449-464.
- San Luis Obispo County (1999). *Safety Element, San Luis Obispo County General Plan*, prepared by Fugro West, Inc., Crawford Multari Clark & Mohr, Don Asquith, PhD, CEG, Cal Poly Landscape Architecture (GIS) Department, December.
- State Water Resources Control Board (1980). "Guidelines for Evapotranspiration Systems", Alan T. Ingham, January.
- Spangler, M.G. and Handy, R.L. (1982), "Loads on Underground Conduit", *Soil Engineering*, Harper and Rowe, 4<sup>th</sup> edition, pp. 727-761.
- U.S. Geologic Survey (2004), "CISN Peak Acceleration Map (in %g) Epicenter: 11 km NE of San Simeon, CA, Monday December 22, 2003, 11:15:56 AM PST M6.5 N35.71 W121.10 Depth 7.6 km", [www.earthquake.usgs.gov/shakemap/nc/skae/40148755/pga.jpg](http://www.earthquake.usgs.gov/shakemap/nc/skae/40148755/pga.jpg)
- Van Aller, H. (1999), "STEDwin Beta 1.31, the Smart Editor for PC STABL", Annapolis, Maryland.
- Whitman (1990), "Seismic Design and Behavior of Gravity Retaining Walls", Proceedings: *Design and Performance of Earth Retaining Structures*, edited by P.C. Lambe and L.A. Hansen, ASCE Geotechnical Special Publication No. 25, pp. 818-821.



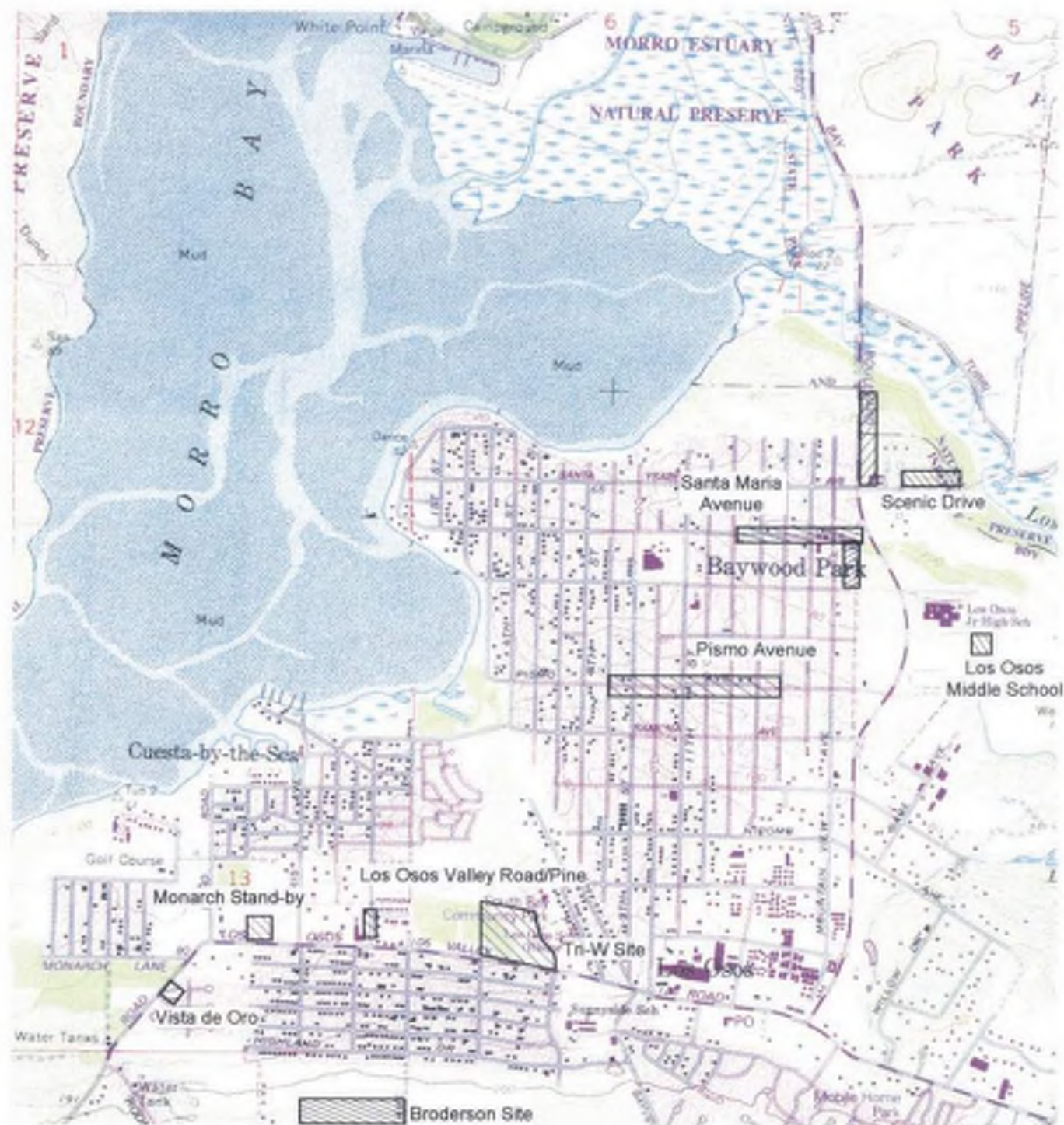

BASE MAP SOURCE: USGS Morro Bay South Quadrangle map, photorevised 1994.

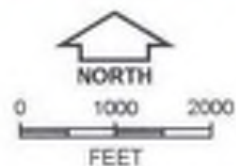

**VICINITY MAP**  
Los Osos Wastewater Project  
Los Osos, California





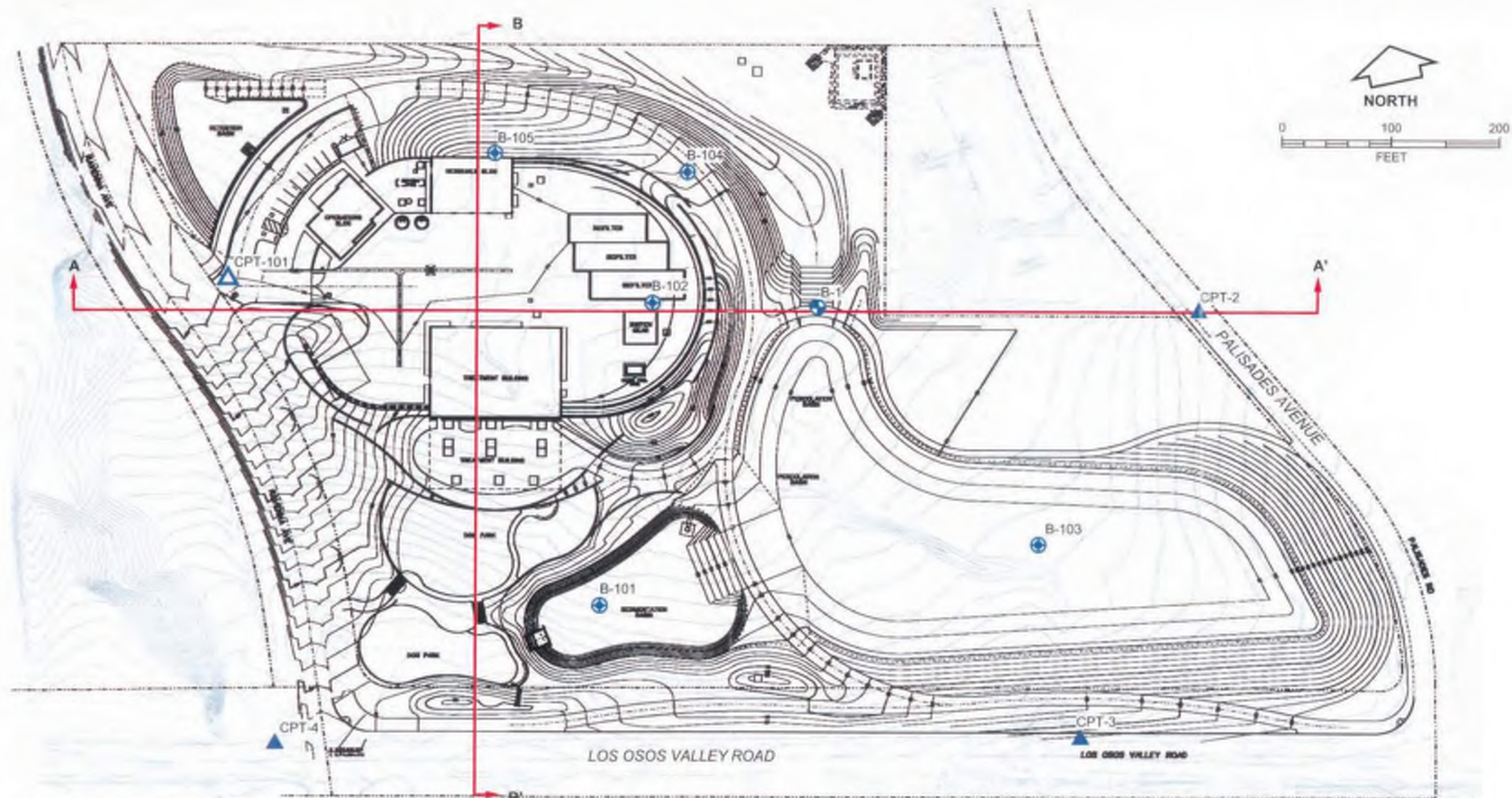

Base Map: MWA (2001), Conceptual Wastewater Collection System

**CUMULATIVE FIELD EXPLORATION PLAN**  
Los Osos Wastewater Project  
Los Osos, California



Base Map: Los Osos Wastewater Treatment Project-Montgomery Watson Harza-Grading Plan, provided January 2004.

**Previous Data:**

-  CPT Site performed December 1999 (CFS 2000)
-  CPT Site performed May 2000 (CFS 2000)
-  Hollow Stem Auger Boring site drilled in May 2000 (CFS 2000)
-  Hollow Stem Auger Boring Site drilled in October 2000 (CFS 2000)



Line of Subsurface Profiles presented in this report.

**FIELD EXPLORATION PLAN**  
for Tri W Treatment Plant  
Los Osos Wastewater Project  
Los Osos, California



BASE MAP SOURCE: USGS Morro Bay South Quadrangle map, photorevised 1994.

**LEGEND**

- P-1  
● Percolation Test Location
- DR-SP1, P-SP1  
● Double-Ring Infiltrometer and Percolation Test Location

**FIELD EXPLORATION PLAN  
Percolation Tests  
Los Osos Wastewater Project  
Los Osos, California**

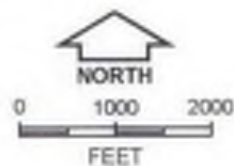

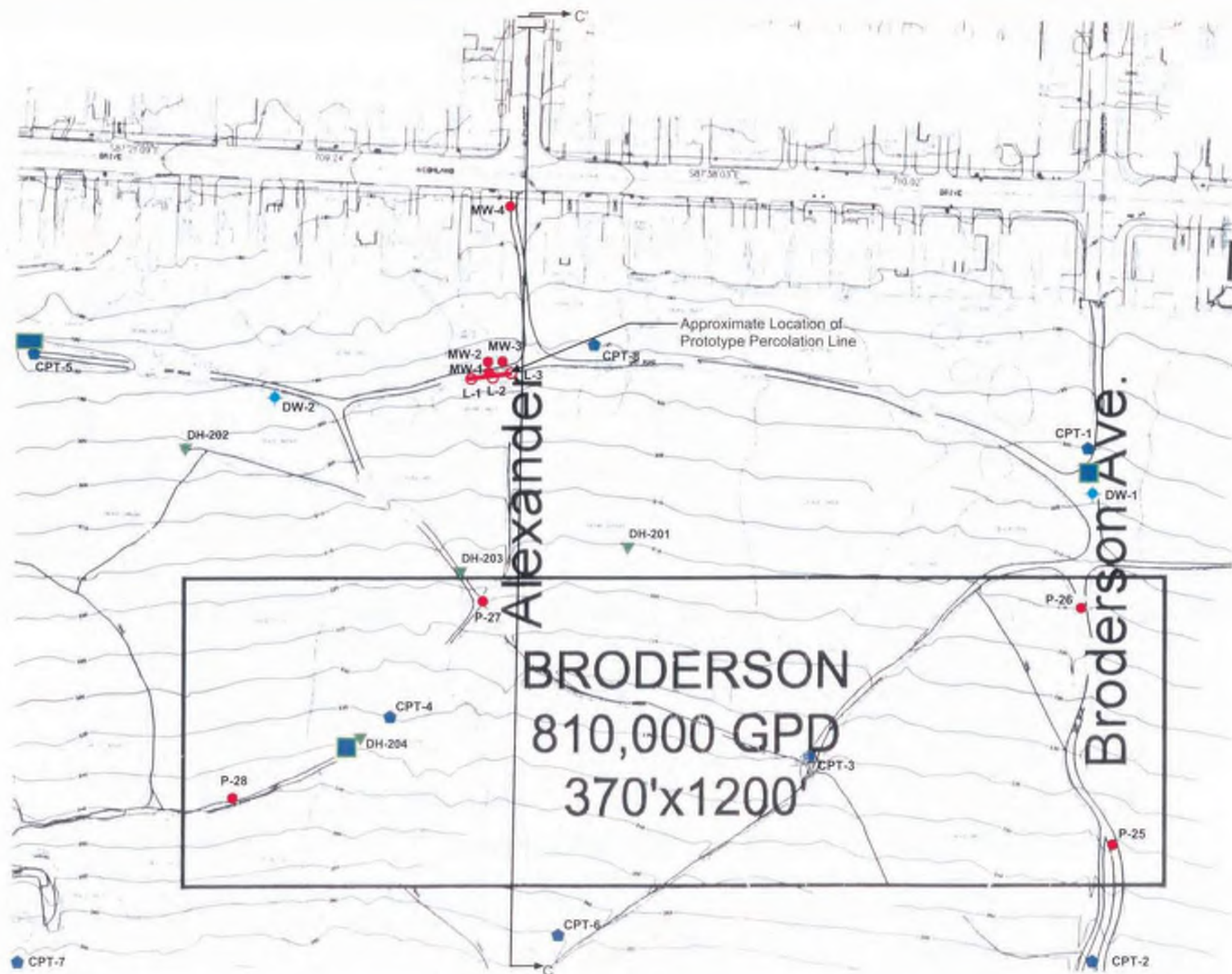

**LEGEND**

- ◆ M&E (1997) Prototype Drywell
- CPT and/or Boring Site (Fugro 1996, M&E 1996)
- ▼ Boring Site (Fugro 1997)
- Monitoring Well for Prototype Percolation Testing
- P-1 ● Percolation Test Location
- L-1 ○ Percolation Test Location at Prototype Percolation Line Site
- M&E (1997) Prototype Percolation Pond
- ↖ Section C-C' extends to approximately 150' north of Los Osos Valley Road



**FIELD EXPLORATION PLAN**  
**Prototype Test Site at Broderon**  
 Los Osos Wastewater Project  
 Los Osos, California

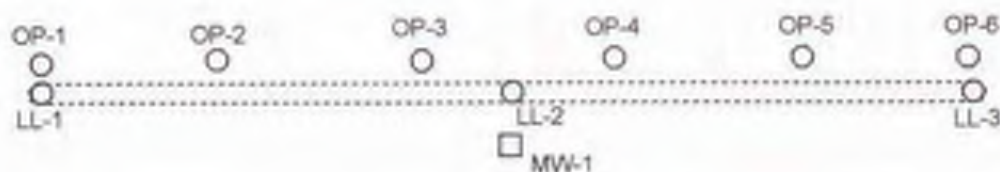

□ MW-3

□ MW-2

**TRENCH PLAN**  
 Scale 1" = 10'±

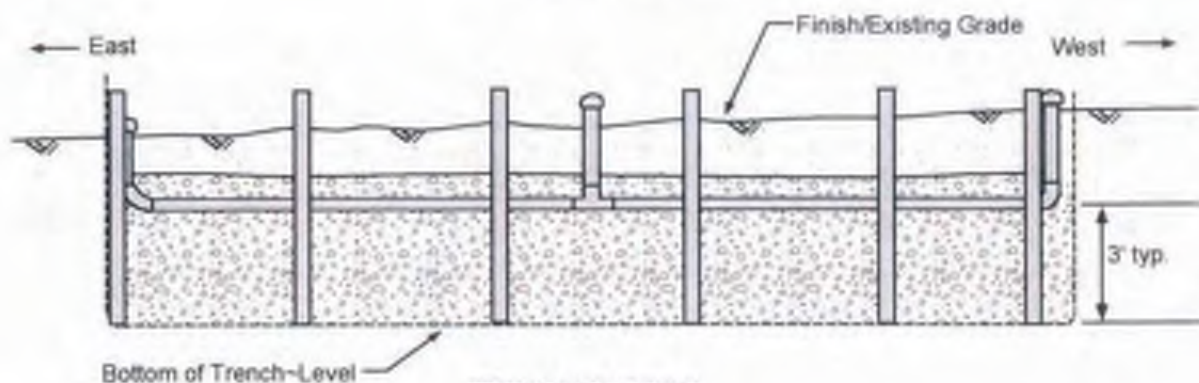

**TRENCH PROFILE**  
 1" = 10'H +/-  
 1" = 5'V +/-

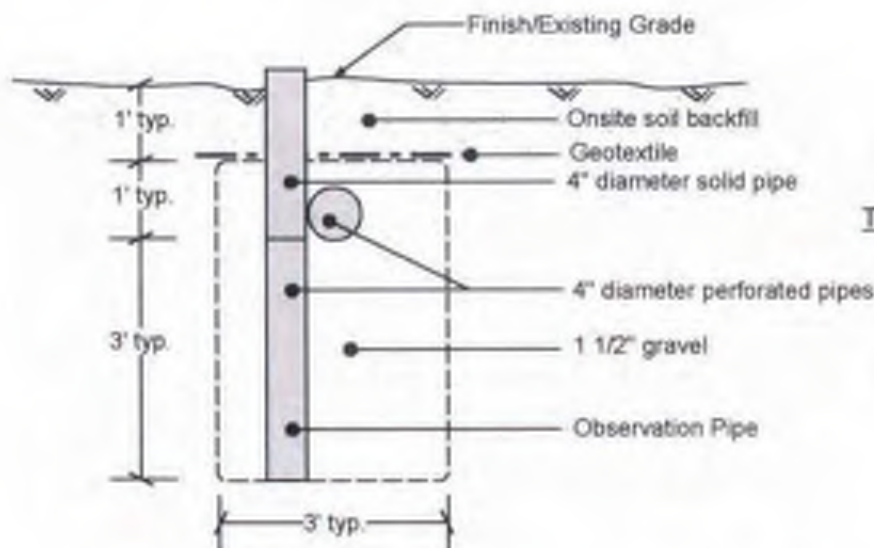

**TRENCH SECTION**  
 N.T.S.

**PROTOTYPE PERCOLATION LINE DETAIL**  
 Los Osos Wastewater Project  
 Los Osos, California



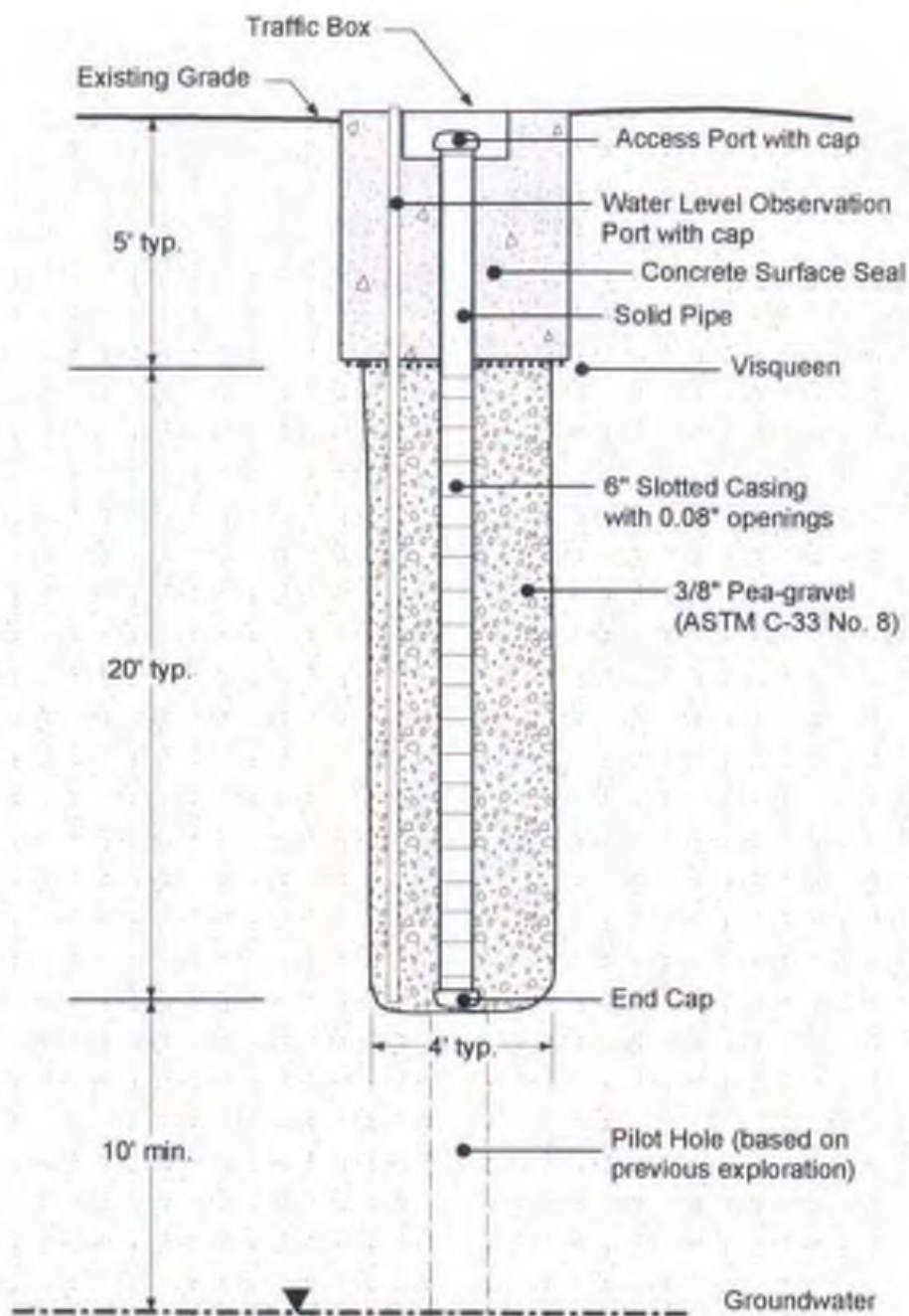

**PROTOTYPE DRYWELL DETAIL**  
Los Osos Wastewater Project  
San Luis Obispo County, California

Drywell Infiltration Rate vs. Head in Well

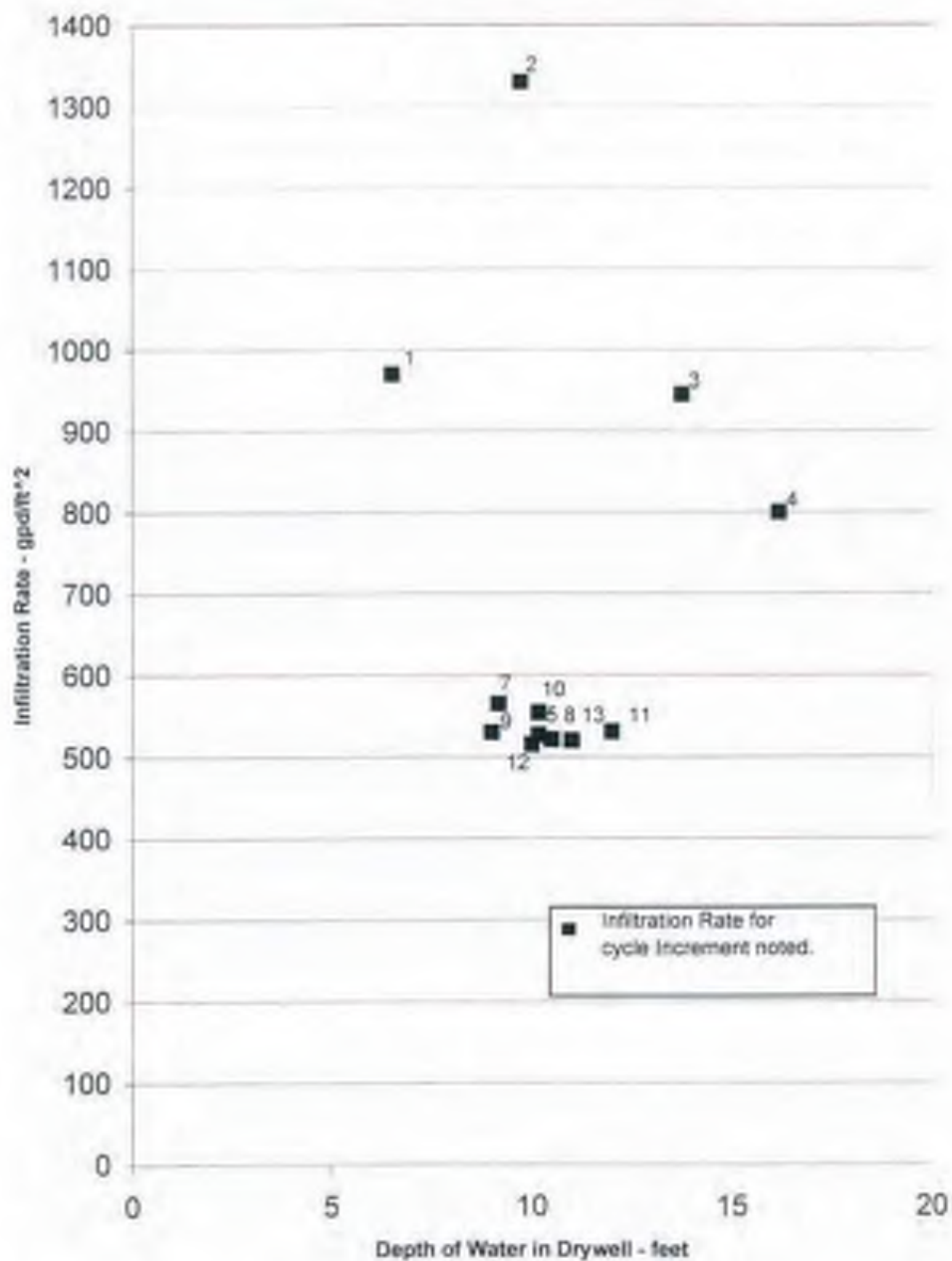

**SUMMARY OF PROTOTYPE TEST RESULTS**  
**Drywell**  
Los Osos Wastewater Project  
Los Osos, California

### Infiltration Rate vs. Head

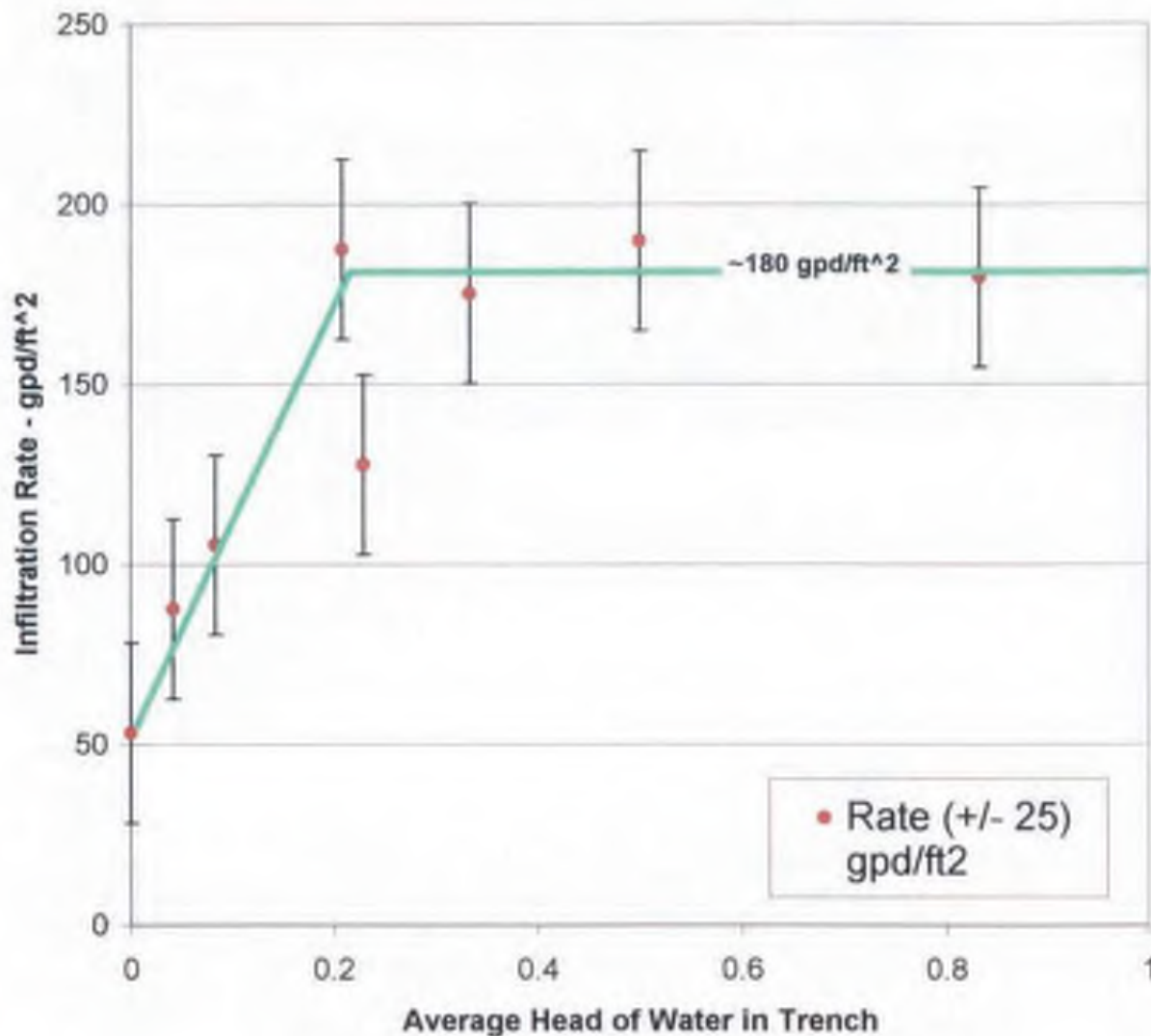

#### SUMMARY OF PROTOTYPE TEST RESULTS

##### Percolation Line

Los Osos Wastewater Project  
Los Osos, California

### Percolation vs. Time

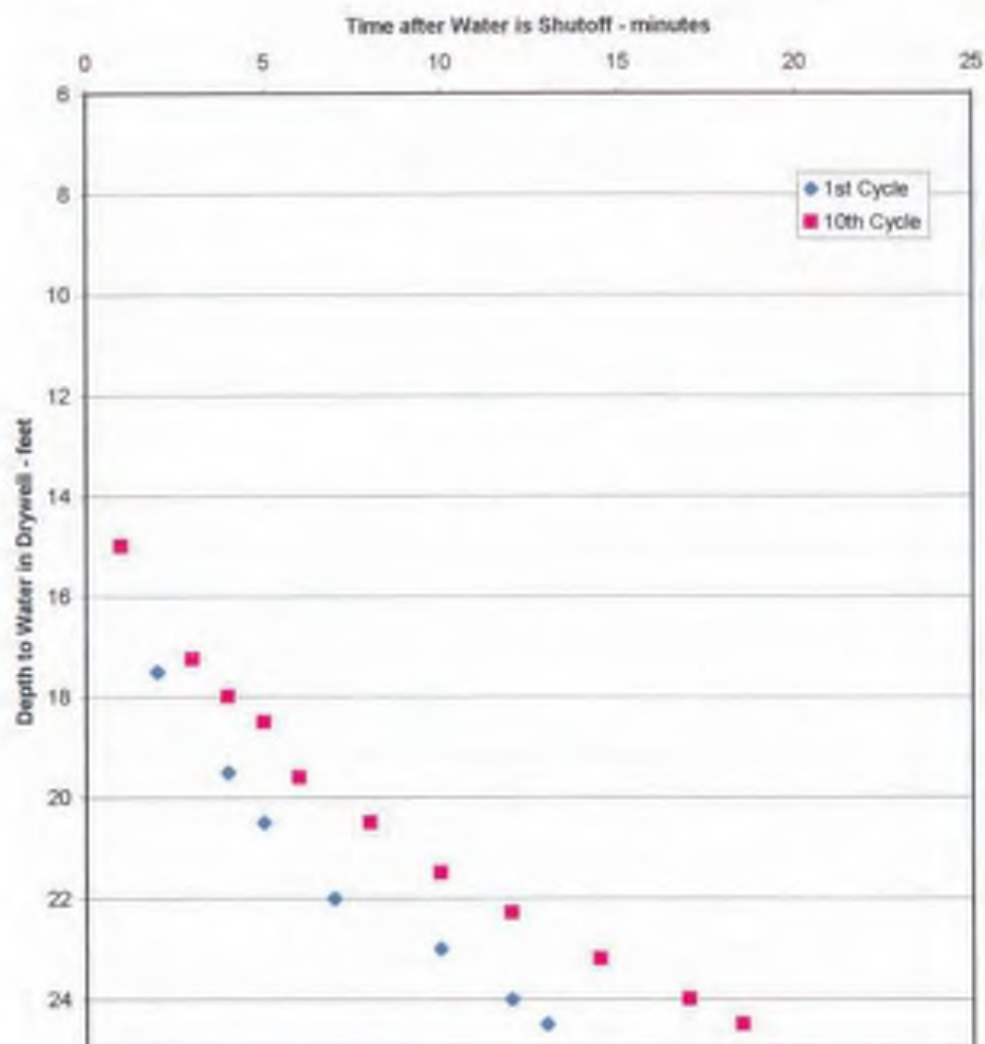

**SUMMARY OF PROTOTYPE TESTING**  
**Drywell Percolation**  
Los Osos Wastewater Project  
Los Osos, California

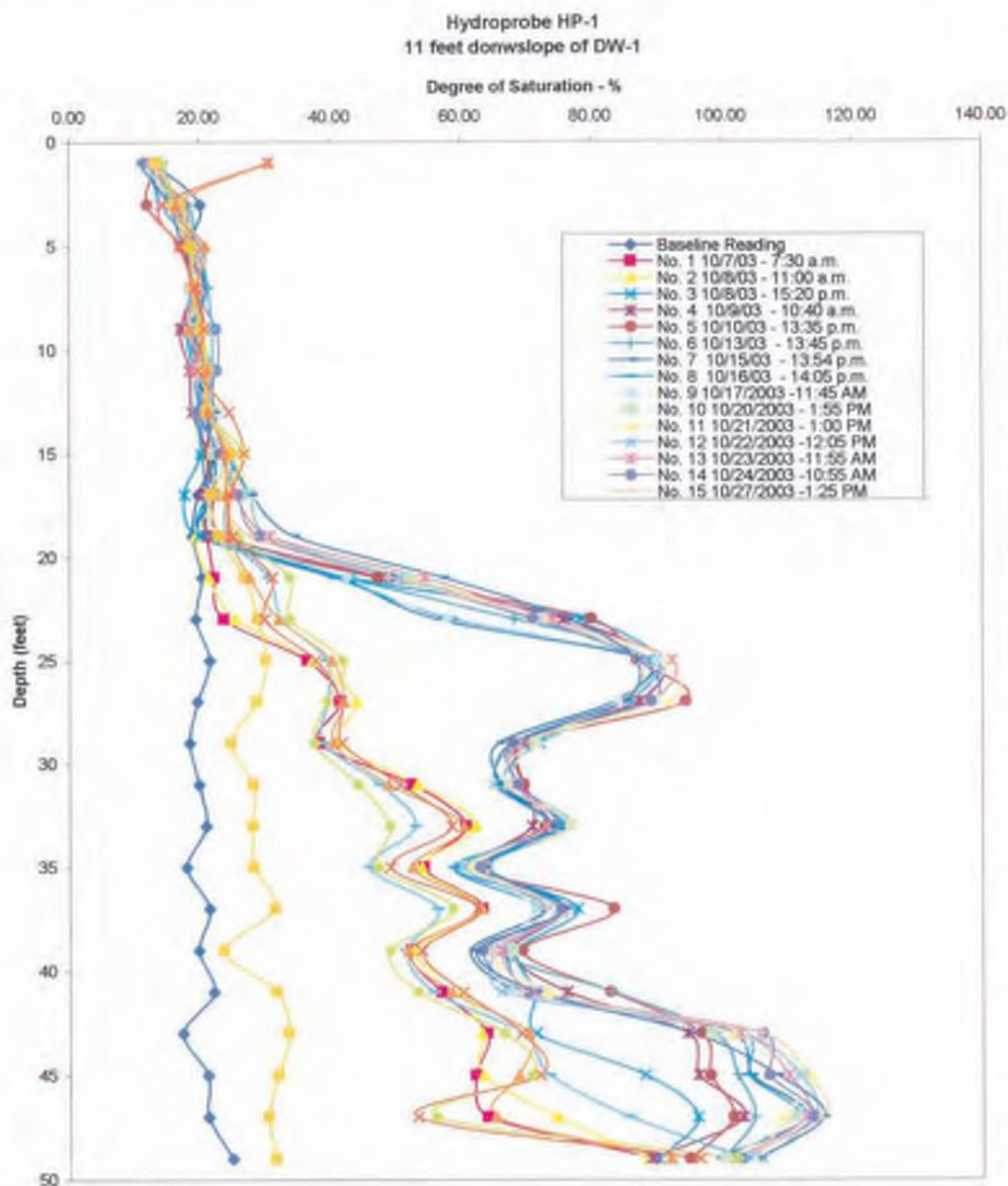

**SUMMARY OF PROTOTYPE DRYWELL TESTING**  
**HP-1 Hydro Probe Data**  
Los Osos Wastewater Project  
Los Osos, California

Hydroprobe HP-2  
(53 feet downslope of DW-1)

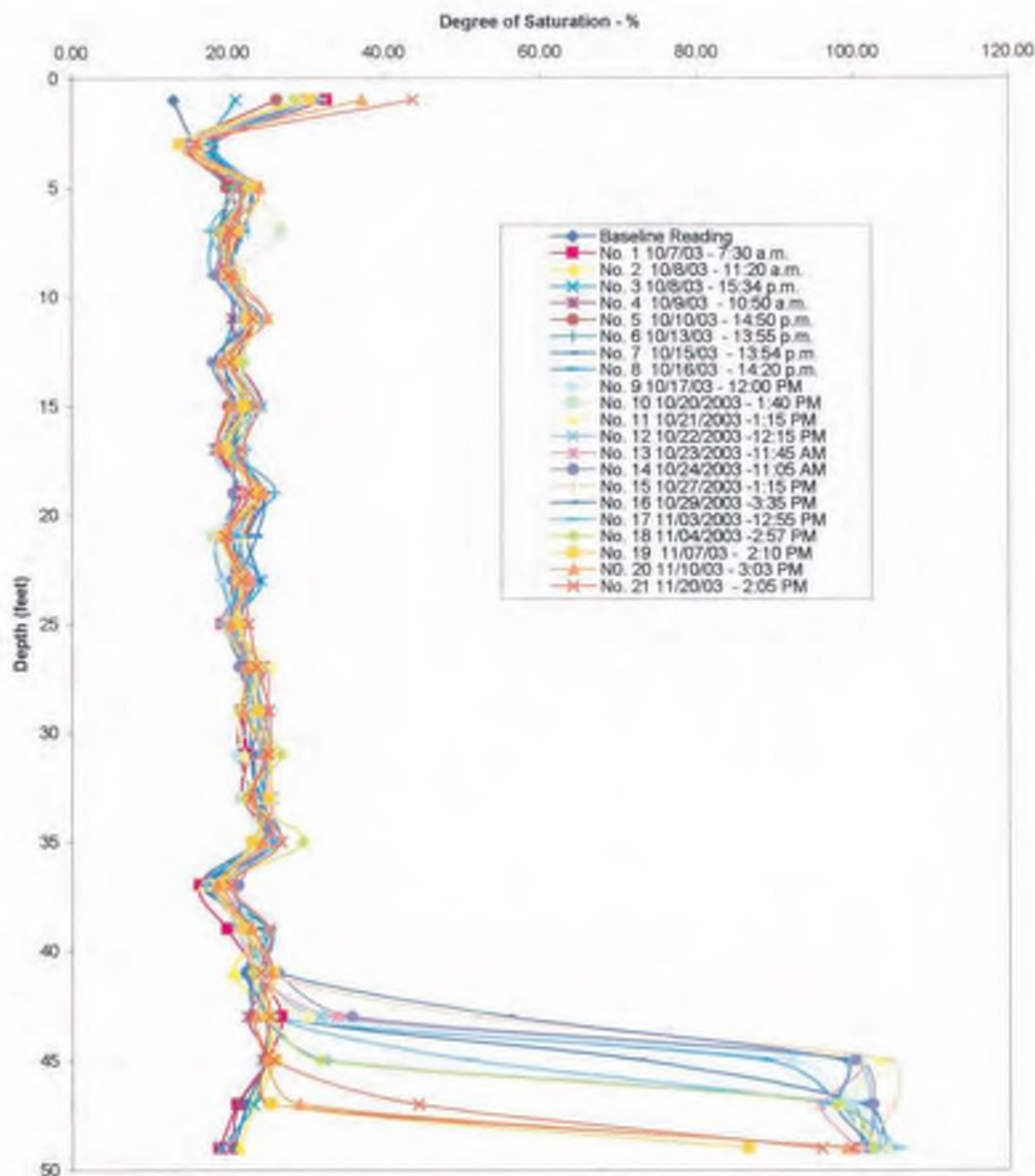

**SUMMARY OF PROTOTYPE DRYWELL TESTING**  
**HP-2 Hydro Probe Data**  
Los Osos Wastewater Project  
Los Osos, California

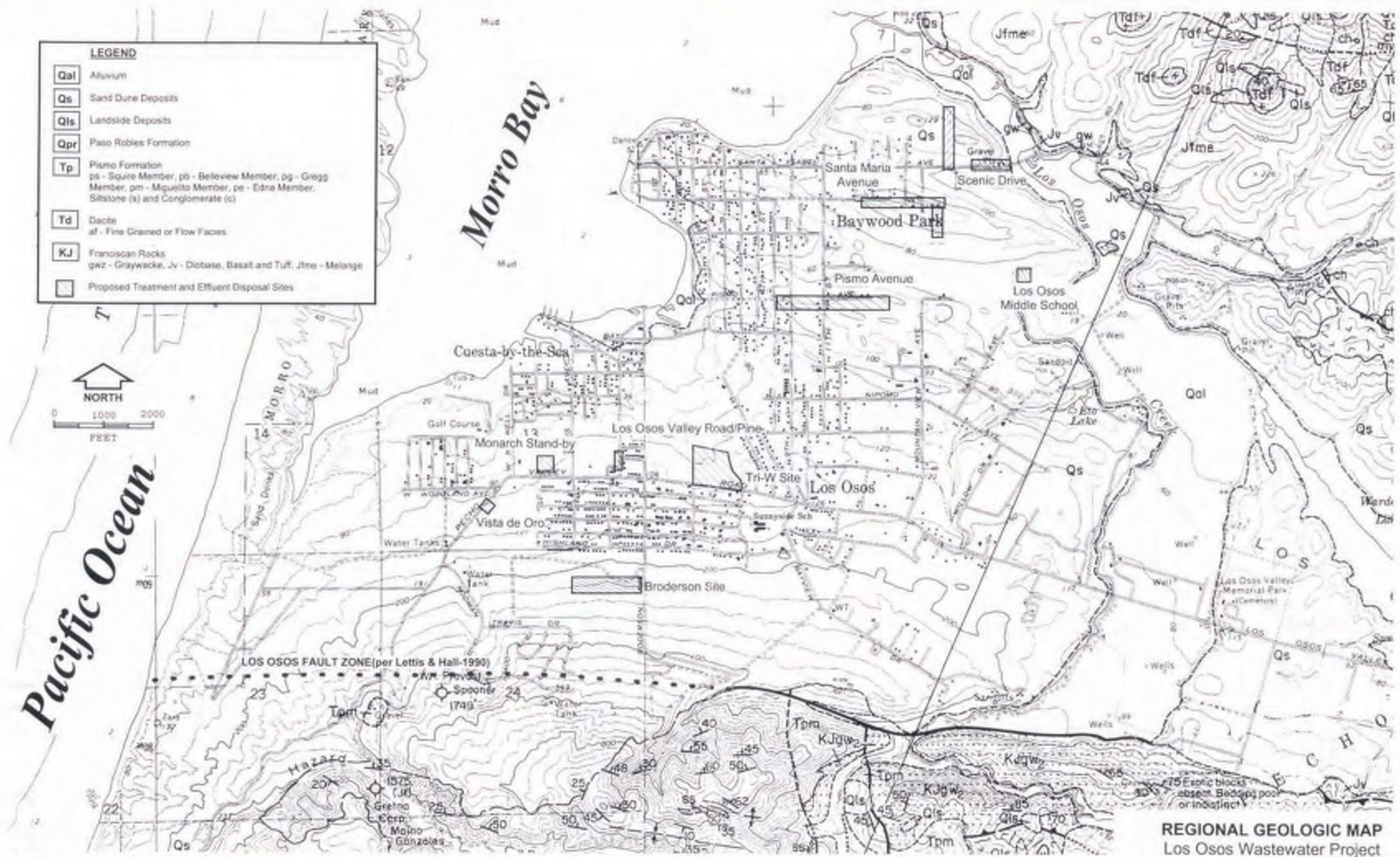

BASE MAP: Hall (1973), Geologic Map of the Morro Bay South and Port San Luis Quadrangles, San Luis Obispo, California

**REGIONAL GEOLOGIC MAP**  
Los Osos Wastewater Project  
San Luis Obispo County, California



BASE MAP SOURCE: PG&E (July-1988), Final Report of the Diablo Canyon, Long Term Seismic Program

Legend

 Fault; dotted where approximately located, inferred, or concealed



**REGIONAL FAULT MAP**  
Los Osos Wastewater Project  
San Luis Obispo County, California



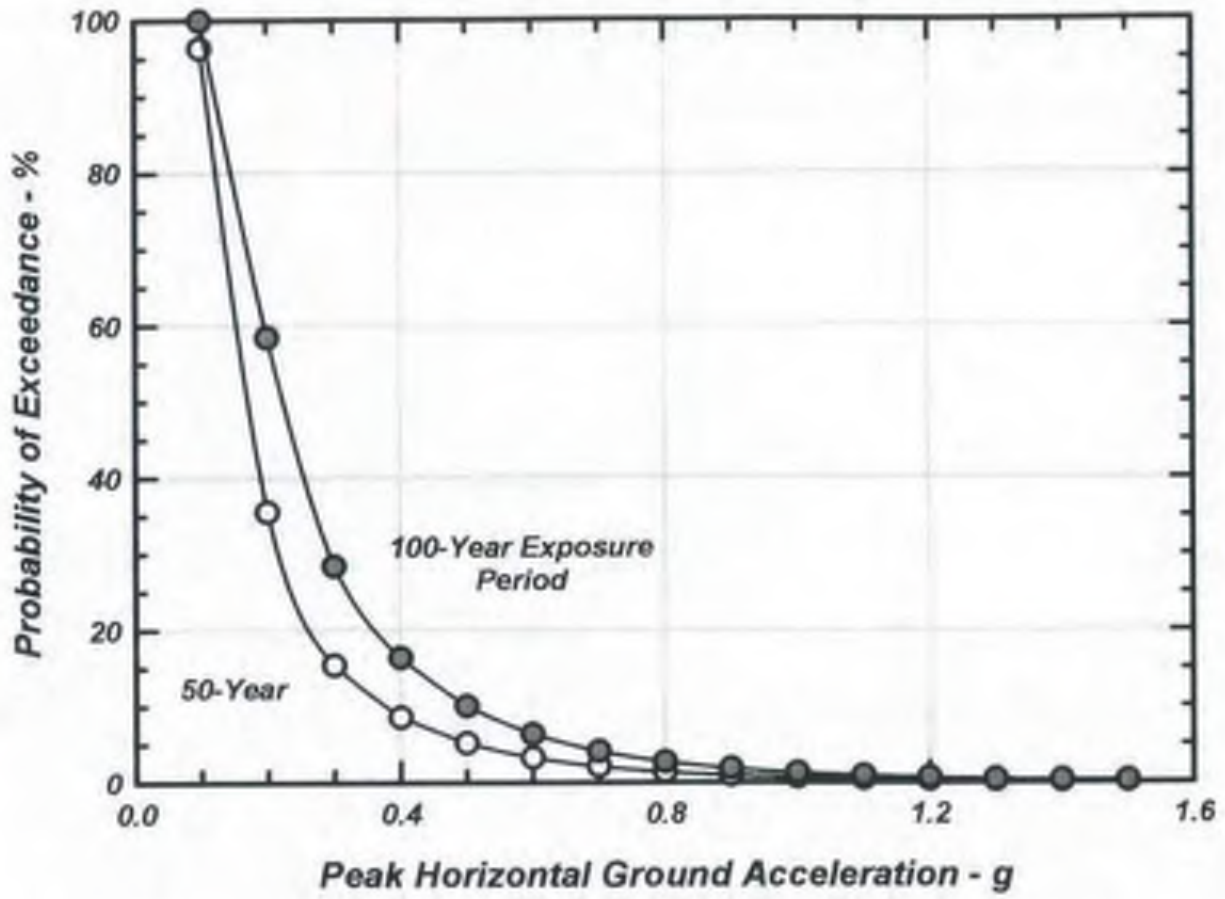

**RESULTS OF PROBABILISTIC SEISMIC HAZARD ANALYSIS  
PLOT SHOWING PROBABILITY OF EXCEEDENCE VERSUS  
PEAK HORIZONTAL GROUND ACCELERATION**  
Los Osos Wastewater Project  
Los Osos, California

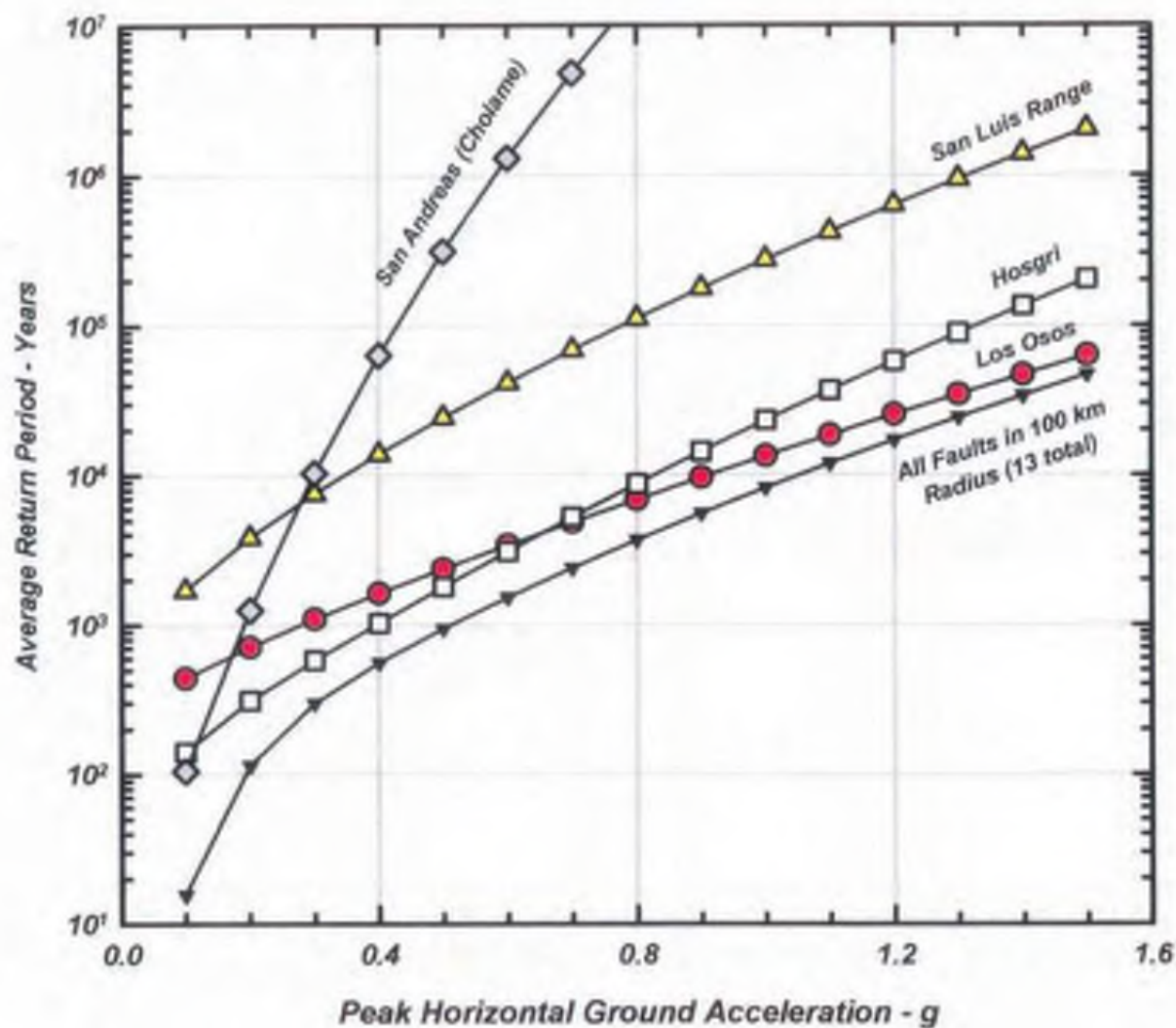

**RESULTS OF PROBABILISTIC SEISMIC HAZARD ANALYSIS  
PLOT SHOWING AVERAGE RETURN PERIOD VERSUS  
PEAK HORIZONTAL GROUND ACCELERATION**  
Los Osos Wastewater Project  
Los Osos, California

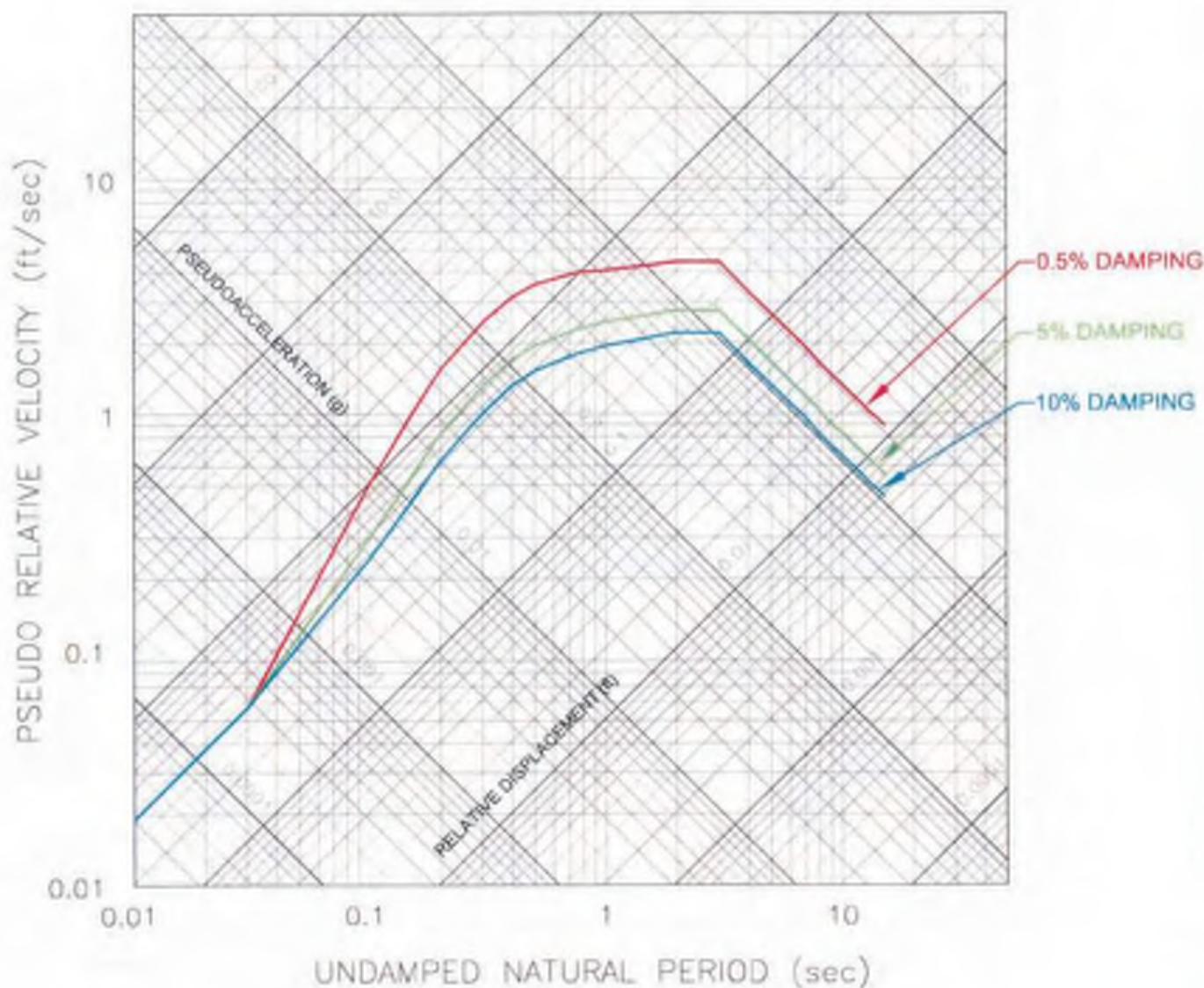

**RESULTS OF PROBABILISTIC SEISMIC HAZARD ANALYSIS**  
Design Response Spectra - 10% Chance of Exceedance in 50 Years  
Los Osos Wastewater Project  
San Luis Obispo County, California

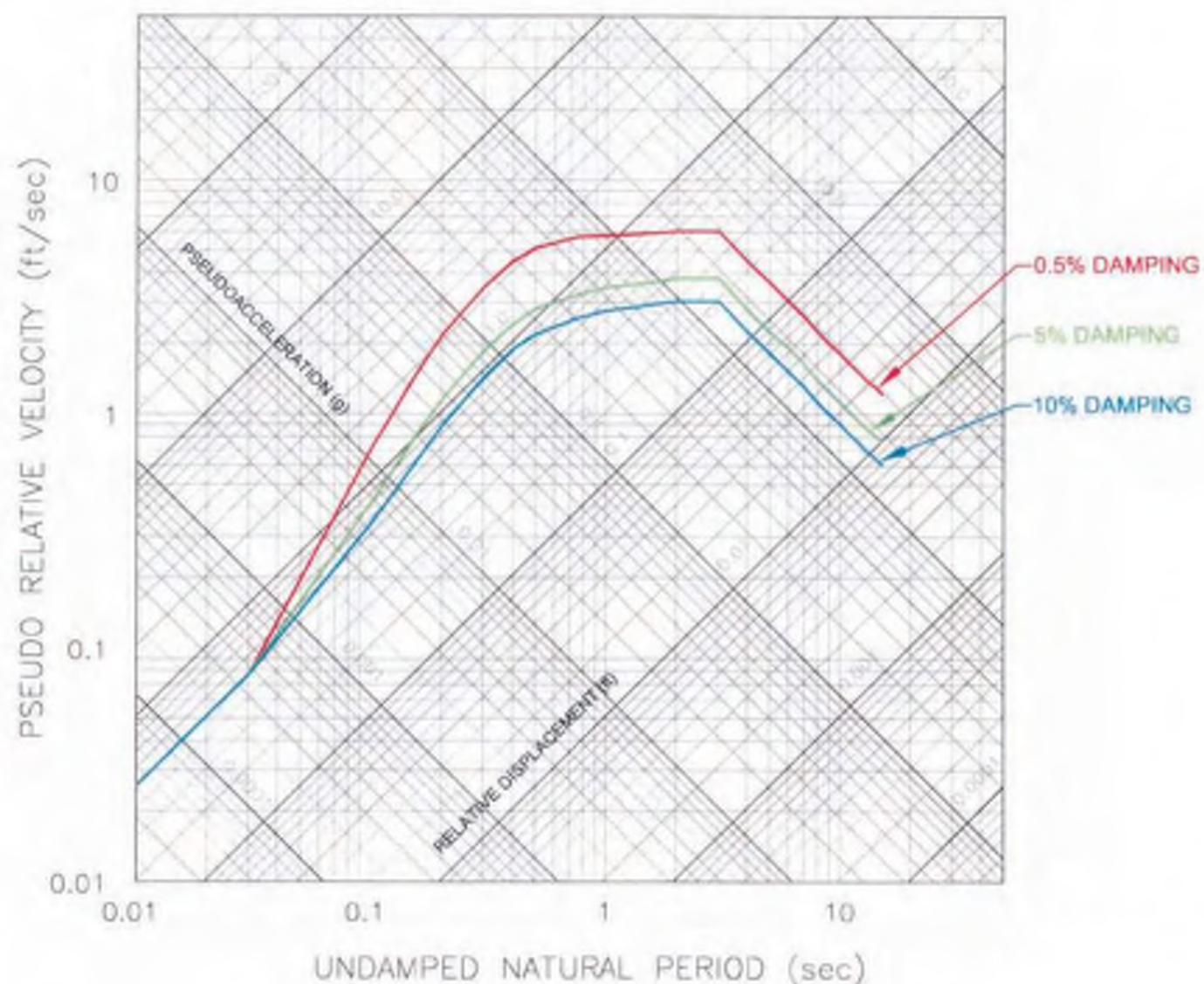

20051\_0045.dwg: SA\_3055.001\_04.dwg:1/24/05 10:58 AM

**RESULTS OF PROBABILISTIC SEISMIC HAZARD ANALYSIS**  
Design Response Spectra - 10% Chance of Exceedance in 100 Years  
Los Osos Wastewater Project  
San Luis Obispo County, California

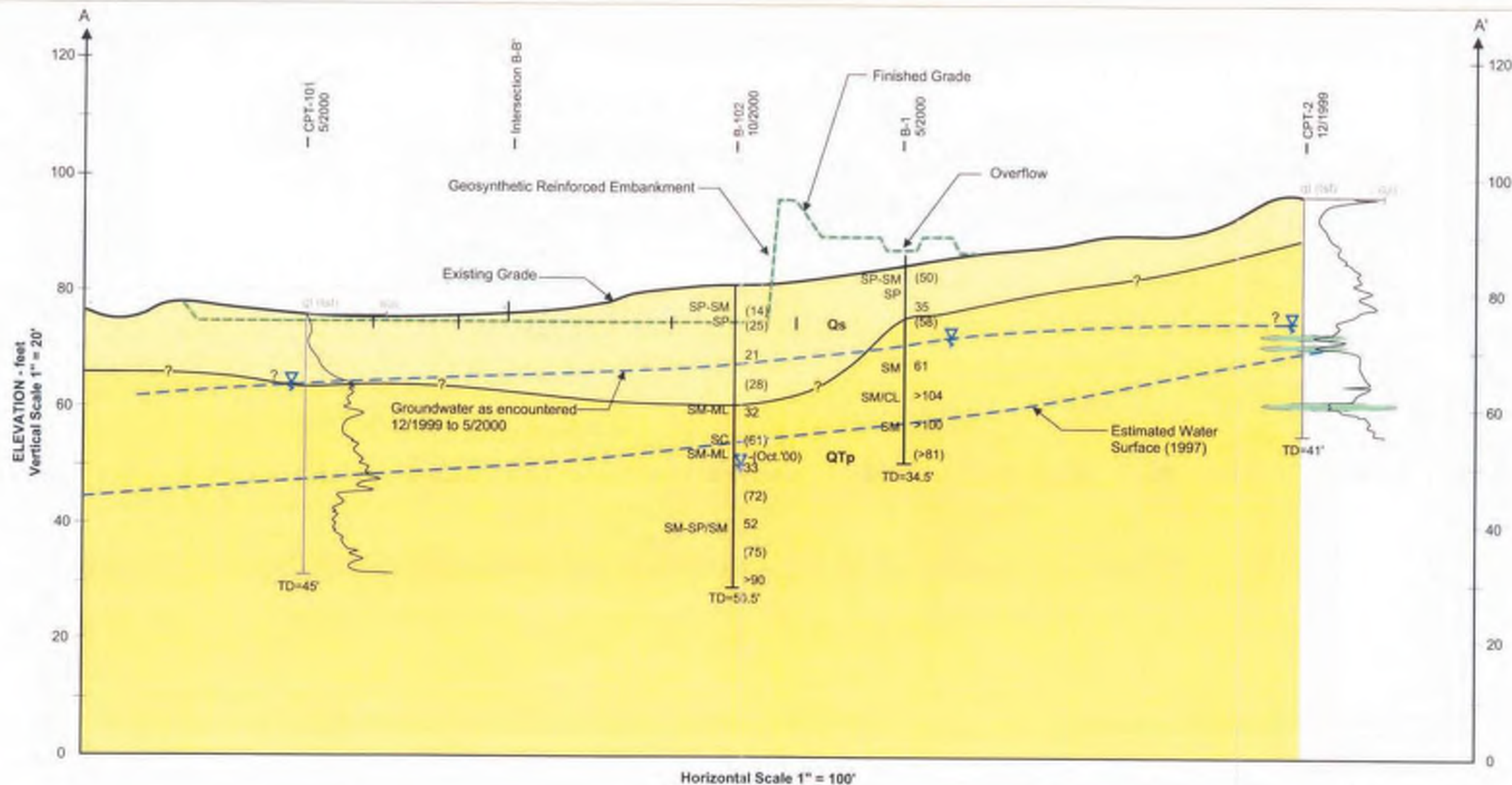

**SUBSURFACE PROFILE A - A'**  
for Tri W Treatment Plant  
Los Osos Wastewater Project  
San Luis Obispo County, California

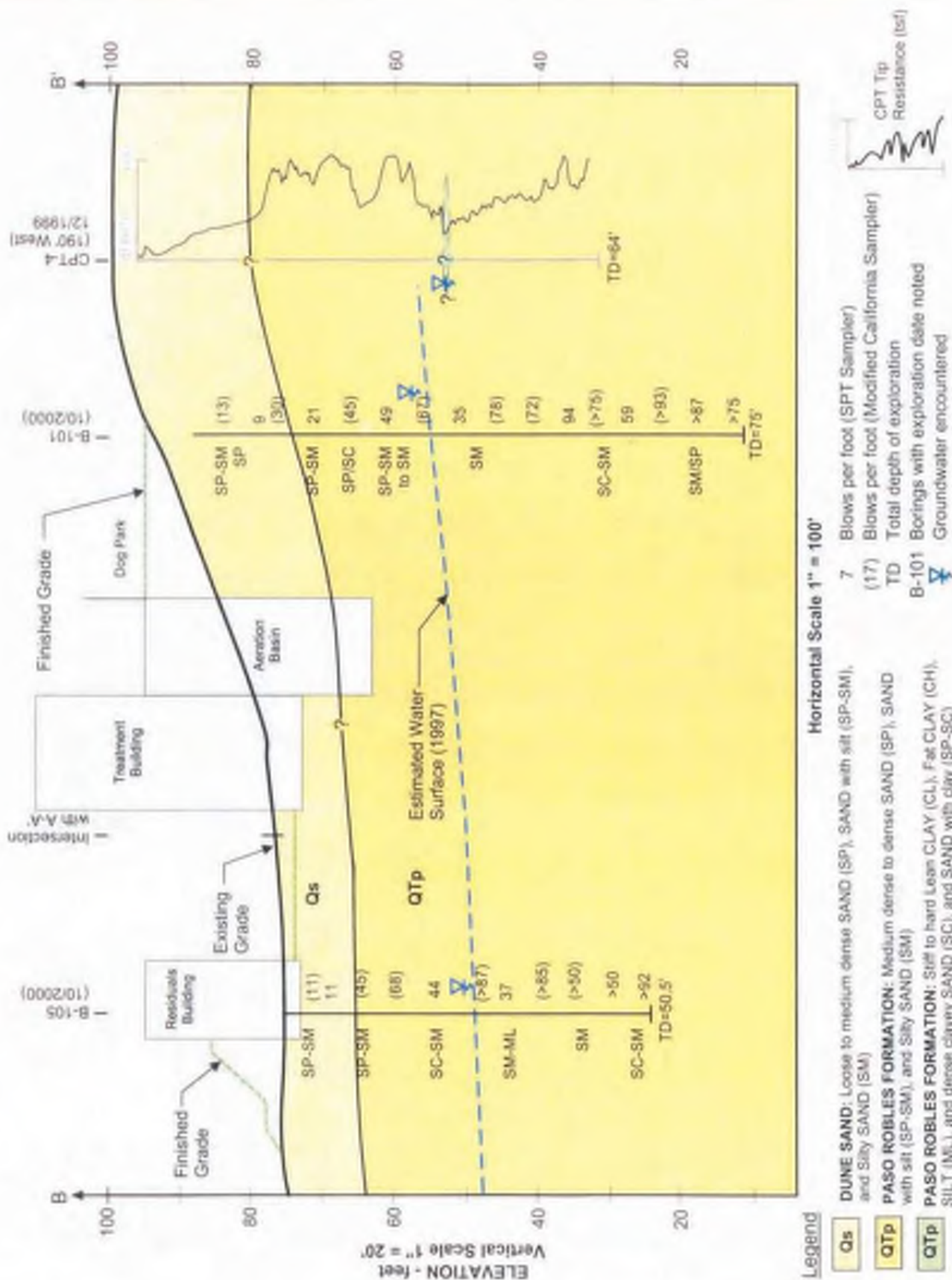

**SUBSURFACE PROFILE B - B'**  
 for Tri W Treatment Plant  
 Los Osos Wastewater Project  
 San Luis Obispo County, California

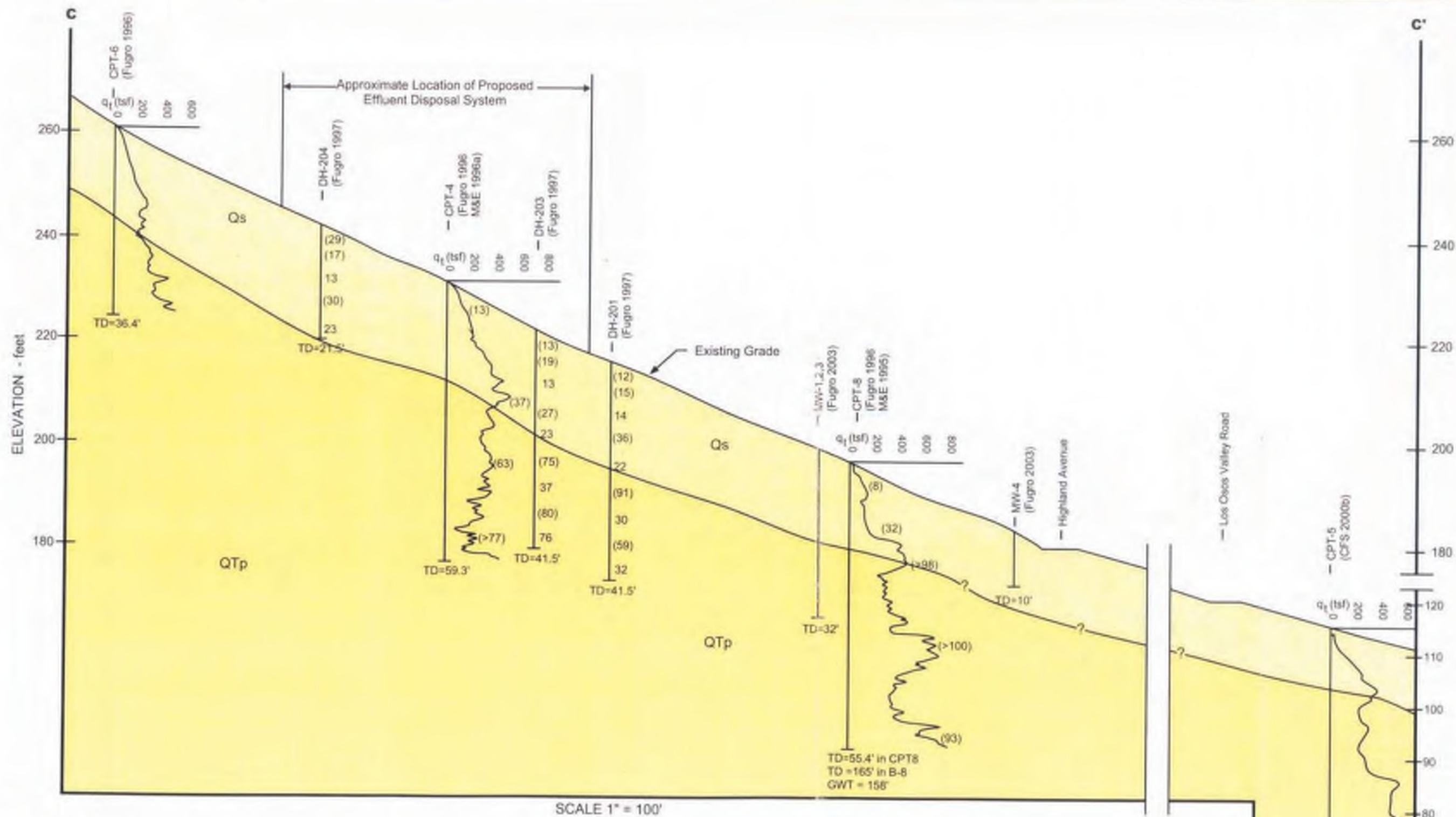

**Legend**

- Qs** DUNE SAND: Loose to medium dense SAND (SP), SAND with silt (SP-SM), and Silty SAND (SM)
- QTp** PASO ROBLES FORMATION: Medium dense to very dense SAND (SP), SAND with silt (SP-SM), and Silty SAND (SM)

- 7 Blows per foot (SPT Sampler)
- (17) Blows per foot (Modified California Sampler)
- TD Total depth of exploration
- GWT Groundwater Table
- B-101 Borings with exploration date noted
- ⚡ Groundwater encountered

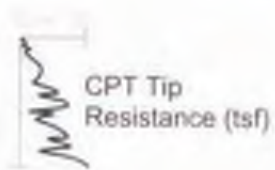

**SUBSURFACE PROFILE C-C'**  
for Broderson Disposal Site  
Los Osos Wastewater Project  
Los Osos, California

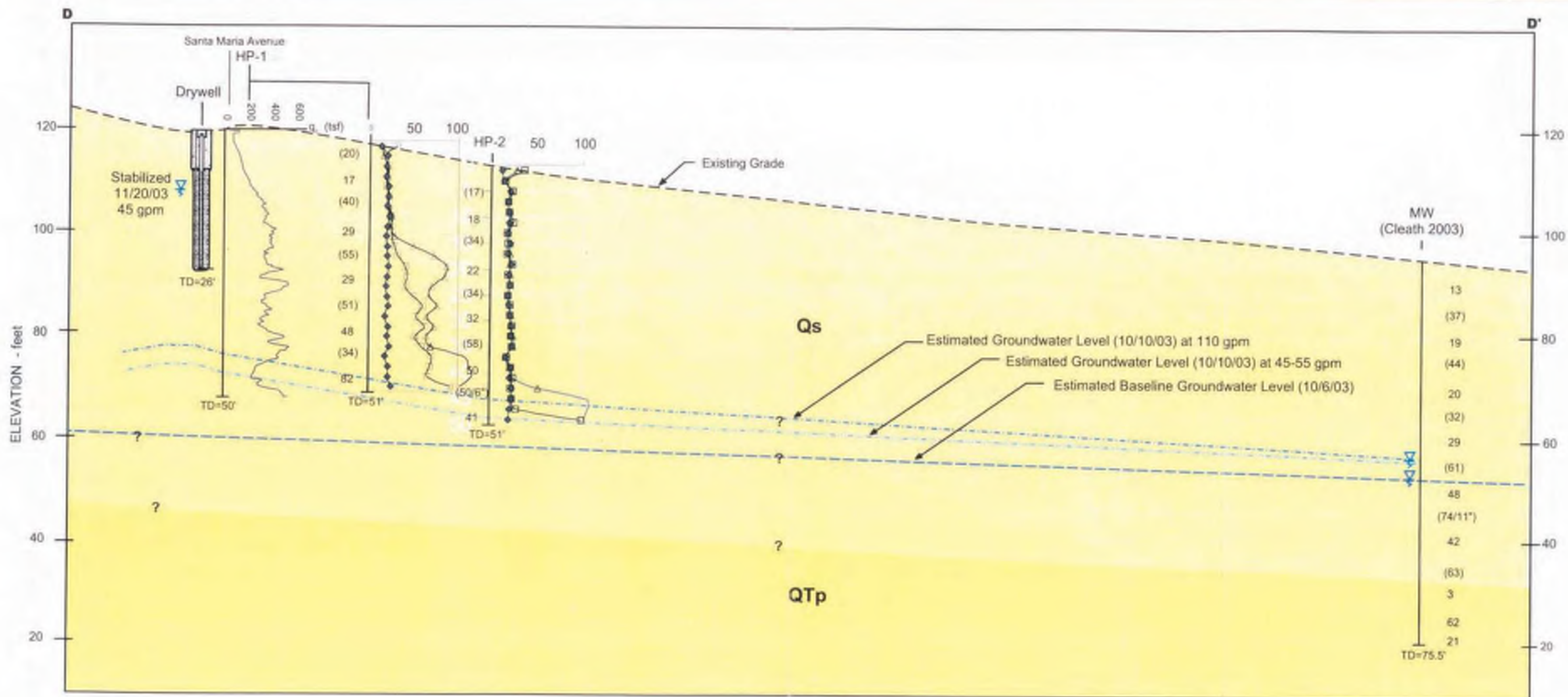

SCALE 1" = 20'

**Legend**

- Qs** DUNE SAND: Medium to very dense SAND (SP) and SAND with silt (SP-SM) with pockets of silt and silty sand.
- QTp** PASO ROBLES FORMATION: Dense to Very SAND (SP), SAND with silt (SP-SM), and Silty SAND (SM)
- 7 Blows per foot (SPT Sampler)
- (17) Blows per foot (Modified California Sampler)
- TD Total depth of exploration
- B-101 Borings with exploration date noted
- ▽ Groundwater encountered

- CPT Sounding  
Tip Resistance vs. Depth
- Hydro Probe Sounding  
Degree of Saturation vs. Depth  
(estimated)
- Baseline Reading (Oct. 6, 2003)
- Stabilized Reading at 110 gpm  
(Oct. 27, 2003)
- Stabilized Reading at 45 gpm  
(Nov. 20, 2003)

**SUBSURFACE PROFILE D-D'**  
for Prototype Drywell Site  
Los Osos Wastewater Project  
Los Osos, California



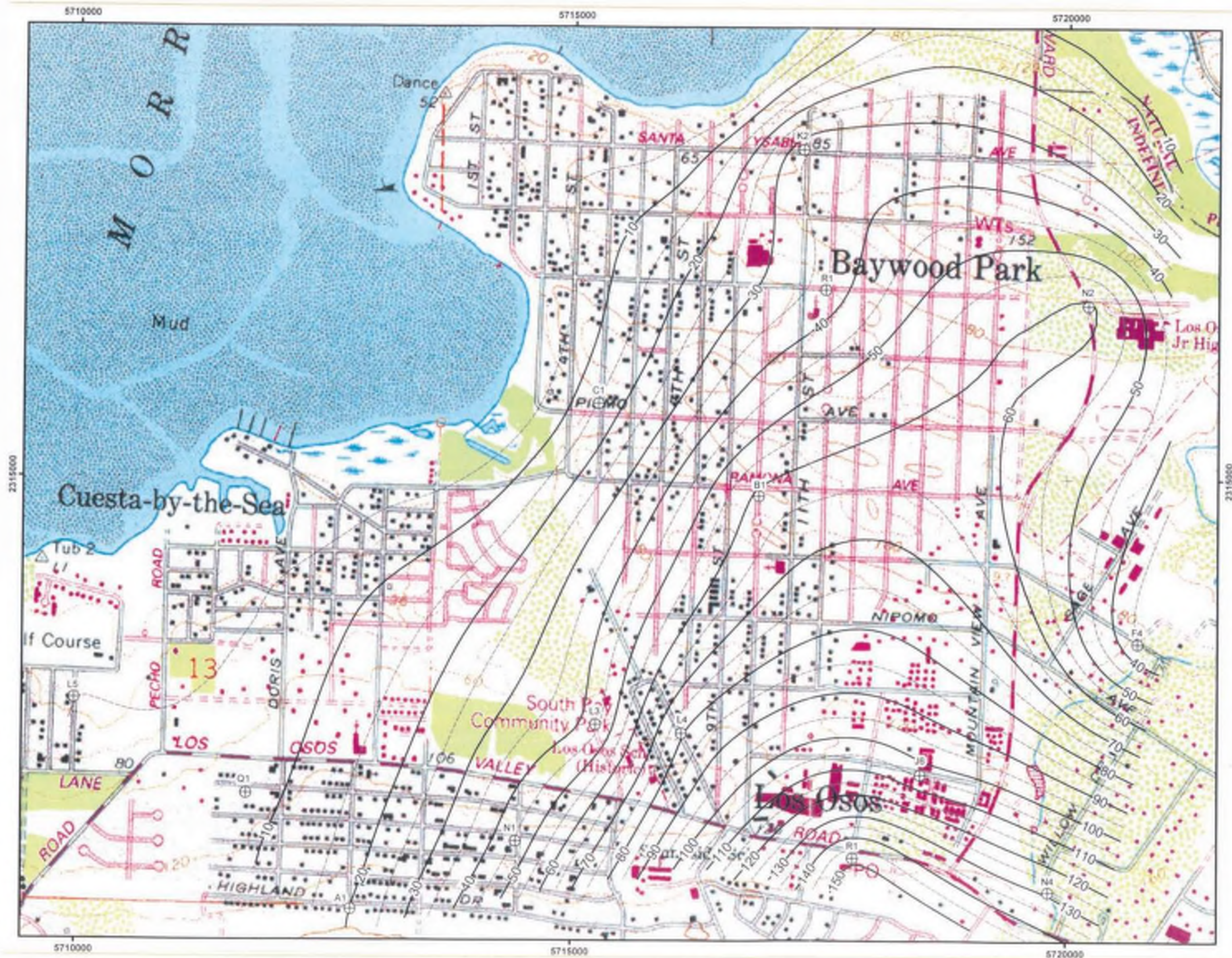

**LEGEND**

- ⊗ County Engineering Monitoring Well
- Estimated Groundwater Elevation Contour  
CI = 10 feet

Note: Groundwater contours are approximate as estimated by straightline interpolation from County well data. Contours may not reflect influences of shallow perching zones. Groundwater levels will vary



**GROUNDWATER CONTOUR MAP**  
**1990 Groundwater Elevations**  
Los Osos Wastewater Project  
San Luis Obispo County, California

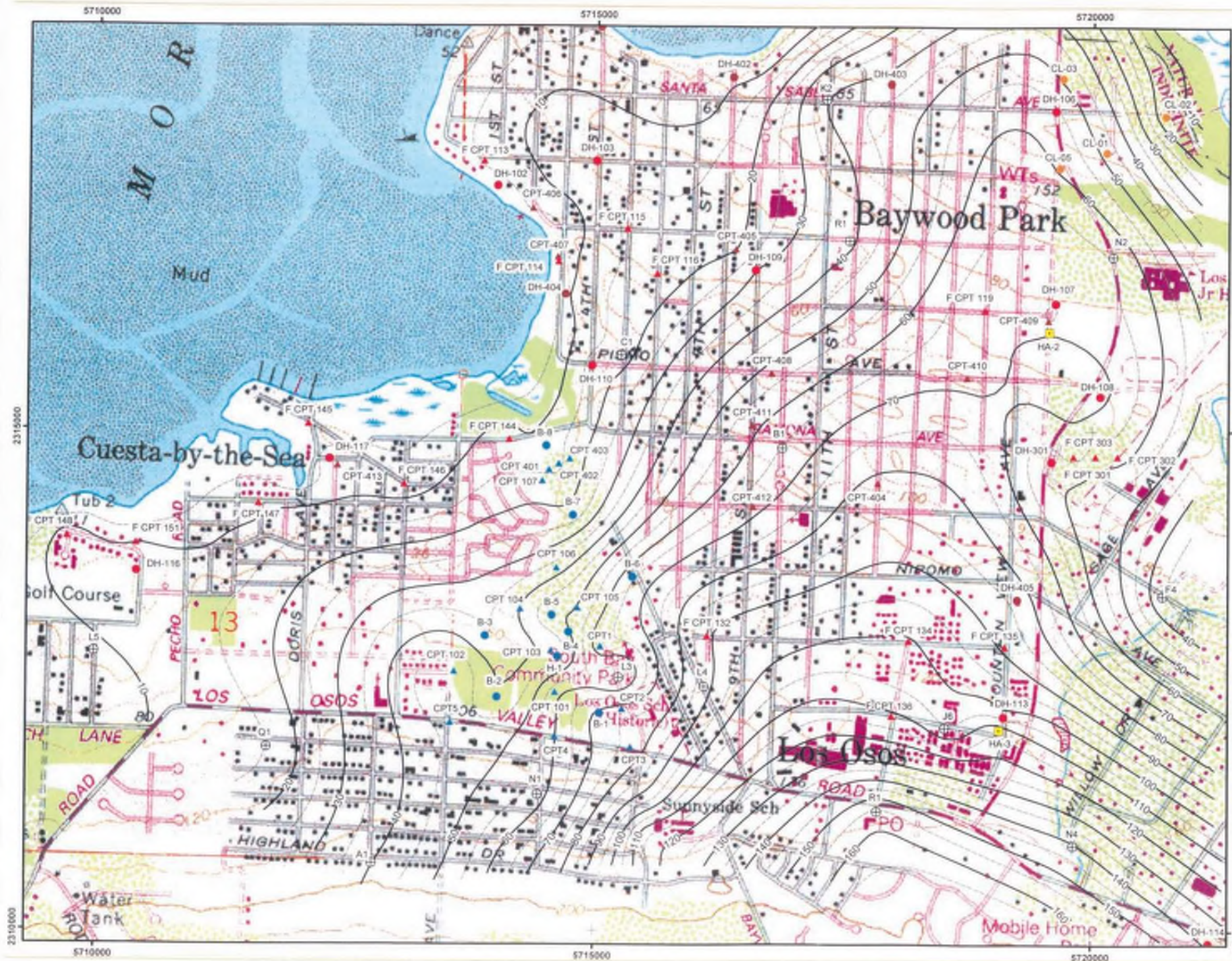

**LEGEND**

- Hollow Stem Auger Boring Site (Fugro, 2003)
- ▲ CPT Site (Fugro, 2003)
- Hollow Stem Auger Boring Site (Fugro, 1997)
- ▲ CPT Site (Fugro, 1997)
- Hollow Stem Auger Boring Site (Cleath, 2003)
- Boring Site (CFS, 1999)
- ▲ CPT Site (CFS, 1999)
- ⊕ County Engineering Monitoring Well
- Hand Auger Site

Estimated Groundwater Elevation Contour

- Cl = 10 feet
- - - Cl = 5 feet

Note: Groundwater contours are approximate as estimated by straightline interpolation between explorations performed at various times. Groundwater levels will vary.



**GROUNDWATER CONTOUR MAP**  
1997 - 2003 Groundwater Elevations  
Los Osos Wastewater Project  
San Luis Obispo County, California

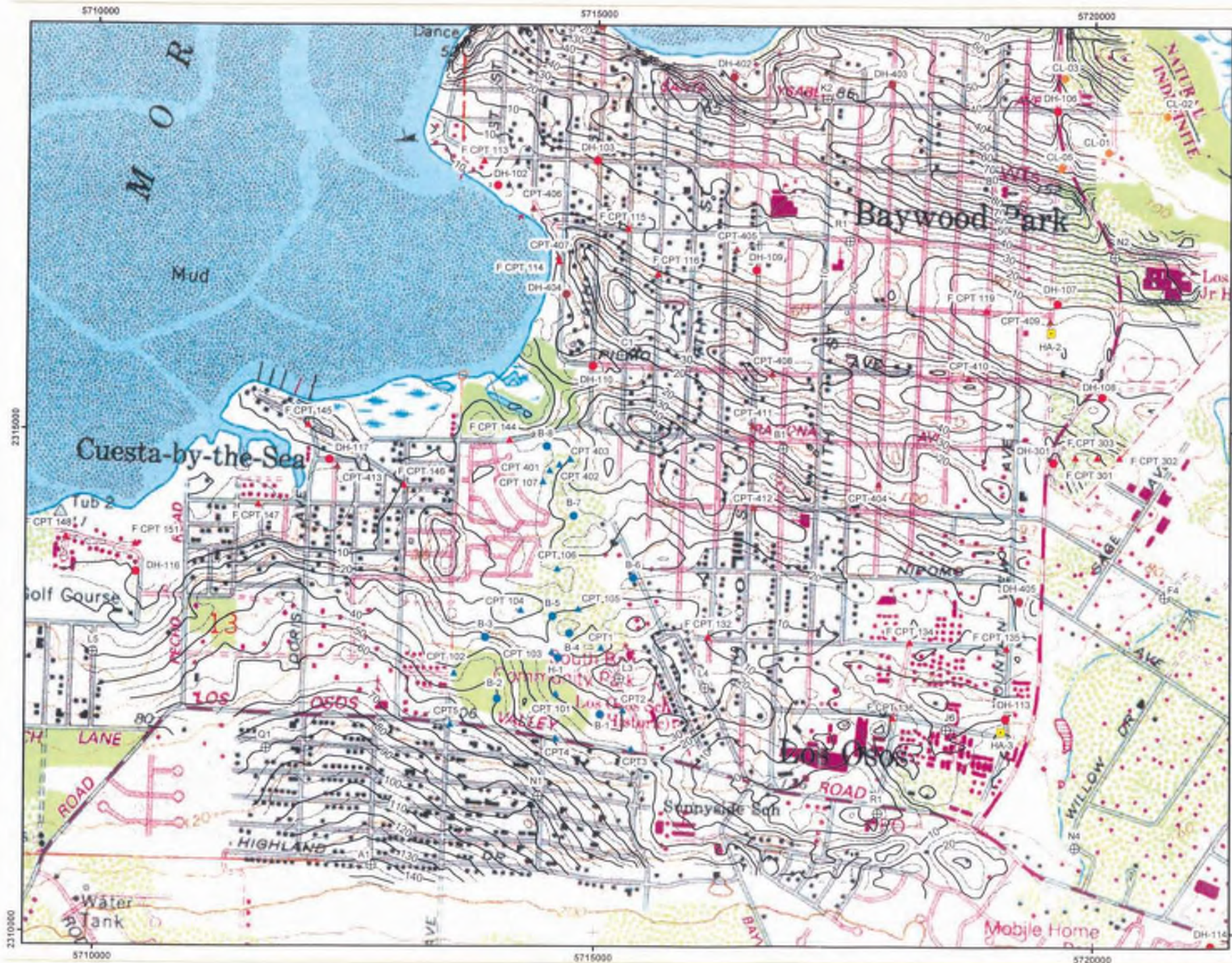

**LEGEND**

- Hollow Stem Auger Boring Site (Fugro, 2003)
- ▼ CPT Site (Fugro, 2003)
- Hollow Stem Auger Boring Site (Fugro, 1997)
- ▼ CPT Site (Fugro, 1997)
- Hollow Stem Auger Boring Site (Cleath, 2003)
- Boring Site (CFS, 1999)
- ▼ CPT Site (CFS, 1999)
- ⊕ County Engineering Monitoring Well
- Hand Auger Site

Depth to Groundwater Contour

- Cl = 10 feet
- - - Cl = 5 feet

Note: Depth to groundwater is approximate and varies seasonally. Depth calculated as difference between surface topography obtained from Montgomery Watson Harza and groundwater levels and contours estimated from explorations.



**GROUNDWATER CONTOUR MAP**  
Depth to 1997 - 2003 Groundwater  
Los Osos Wastewater Project  
San Luis Obispo County, California

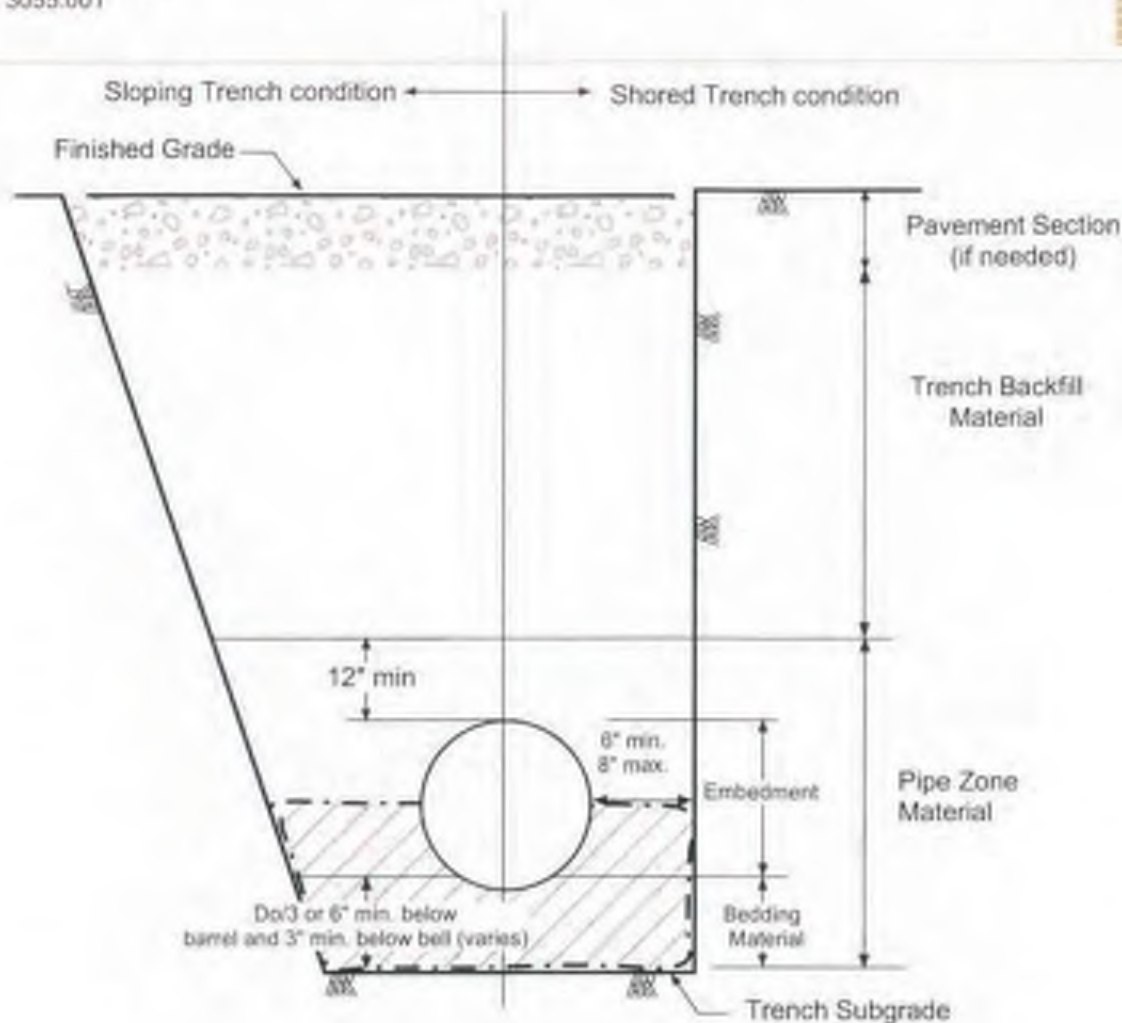

**NOT TO SCALE**

See text for description of trench materials and compaction requirements.



Gravel to be placed below the spring line of pipe when wet sugrade conditions are encountered. Gravel to be encased in a geotextile.

Do = Pipe diameter

Bedding should be gravel encased in geotextile when encountering groundwater.

Where in-situ material meets requirements for bedding, scarify and compact per report.

**SCHEMATIC TRENCH SECTION**  
Los Osos Wastewater Project  
Los Osos, California



**PHOTOS FROM TRENCHING**  
T101-Santa Maria and 10th Street  
Los Osos Wastewater Project  
Los Osos, California



**PHOTOS FROM TRENCHING**  
T102-1st Street and Santa Maria  
Los Osos Wastewater Project  
San Luis Obispo County, California



**PHOTOS FROM TRENCHING**  
T103-Pismo and 4th Street  
Los Osos Wastewater Project  
San Luis Obispo County, California



**PHOTOS FROM TRENCHING**  
T104-Pismo and 13th Street  
Los Osos Wastewater Project  
San Luis Obispo County, California





**PHOTOS FROM TRENCHING**  
T105-Fairchild and Los Olivos  
Los Osos Wastewater Project  
San Luis Obispo County, California



**PHOTOS FROM TRENCHING**  
T106-Fairchild and Los Olivos  
Los Osos Wastewater Project  
San Luis Obispo County, California



**PHOTOS FROM TRENCHING**  
T107-Ramona and 7th Street  
Los Osos Wastewater Project  
San Luis Obispo County, California

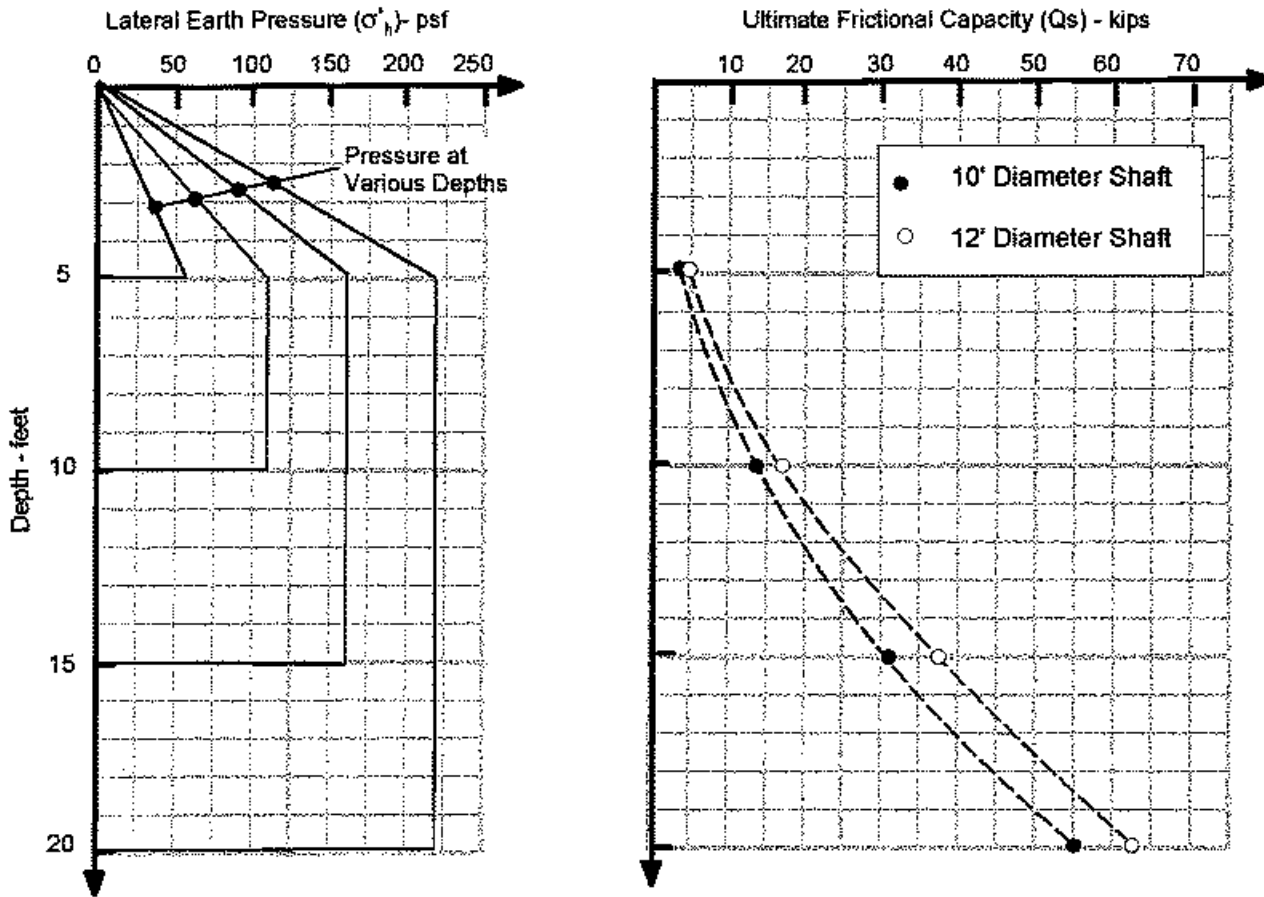

Case Analyzed:

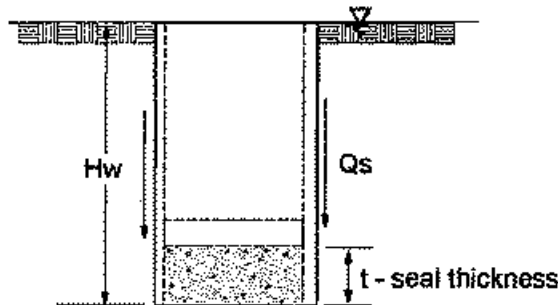

Notes:

1. The lateral earth pressure can be interpolated between the depths shown. The earth pressures are only applicable to cylindrical structures below the water table.
2. Water pressure should be added to the estimated earth pressure at the rate of  $62.4 \text{ pcf} \times H_w$ , in psf. The lateral earth pressure can be doubled, and the water pressure can be neglected, to check non-submerged backfill conditions.
3. No factor of safety is applied to either the lateral earth pressures or frictional capacity. Structures should have a factor of safety of at least 1.25 against uplift.
3. Thickness of seal ( $t$ ) in feet, without friction, can be estimated as  $62.4 \text{ pcf} \times H_w / 150 \text{ pcf}$  with  $H_w$  in feet. Friction and buoyant dead weight can be added resist buoyancy forces.

**LATERAL PRESSURE ON CYLINDRICAL BURIED STRUCTURES**  
Los Osos Wastewater Project  
Los Osos, California

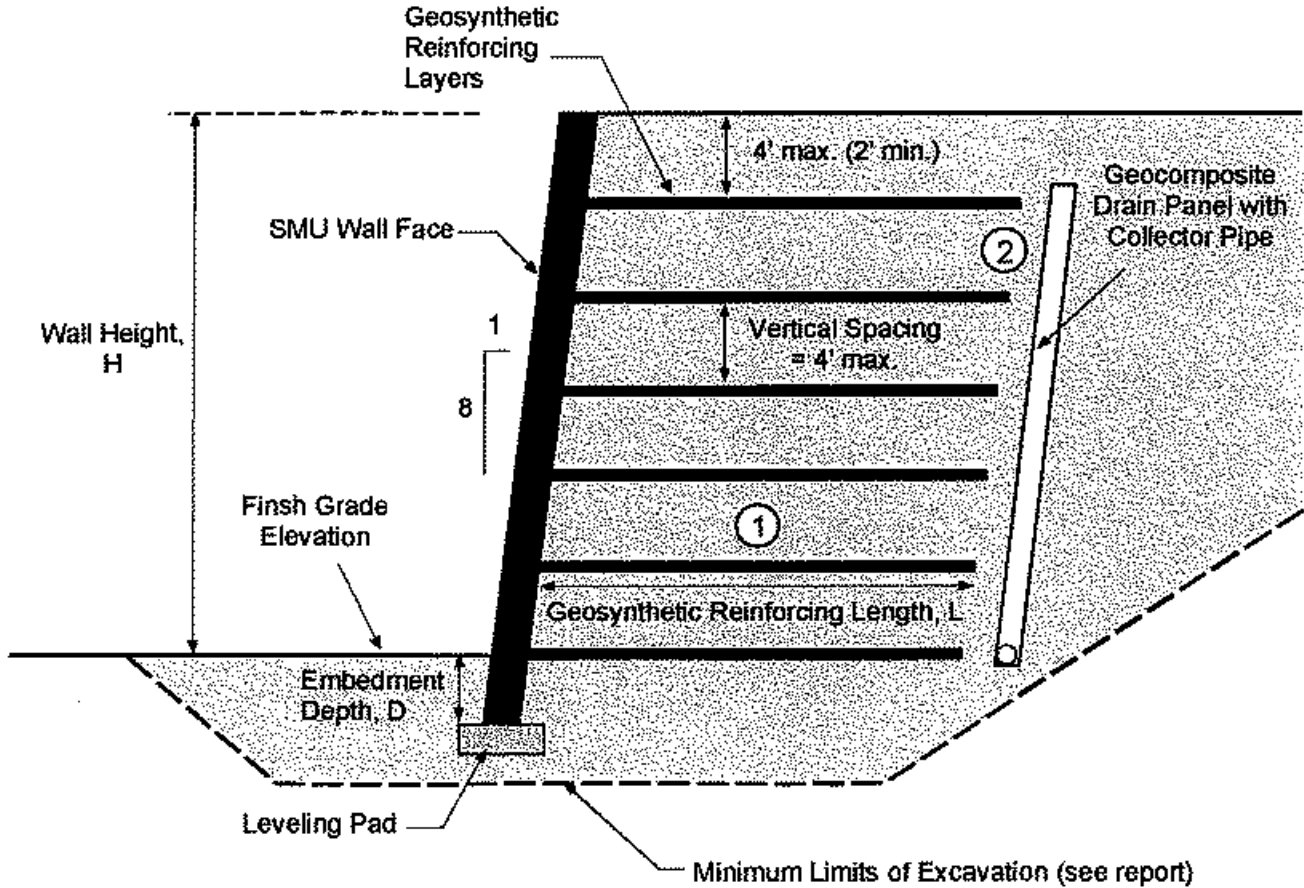

**Notes:**

- ① Geosynthetic reinforcing layers have variable lengths depending on H. Place first reinforcing layer at finish grade elevation.
- ② Use Retaining Wall Backfill within and behind the geosynthetic reinforced area. Compact backfill to at least 95 percent relative compaction.

Wall Height Range (ft)	Minimum Embedment Depth, D (ft)	Min. Geosynthetic Reinforcement Length, L (ft)	Min. Geosynthetic Reinforcement LTDS (lb/ft)
0 – 5*	2.0	—	—
5 – 10	2.0	8	5,000
10 – 15	2.0	10	5,000
15 – 20	3.0	14	5,000
20 – 25	3.0	18	5,000

\* - Depending on wall height, geosynthetic reinforcing may not be needed. Wall contractor should submit shop drawings for SMU walls for review by the Geotechnical Engineer prior to construction.

**TYPICAL DETAIL FOR SMU RETAINING WALLS**  
 Los Osos Wastewater Project  
 Los Osos, California

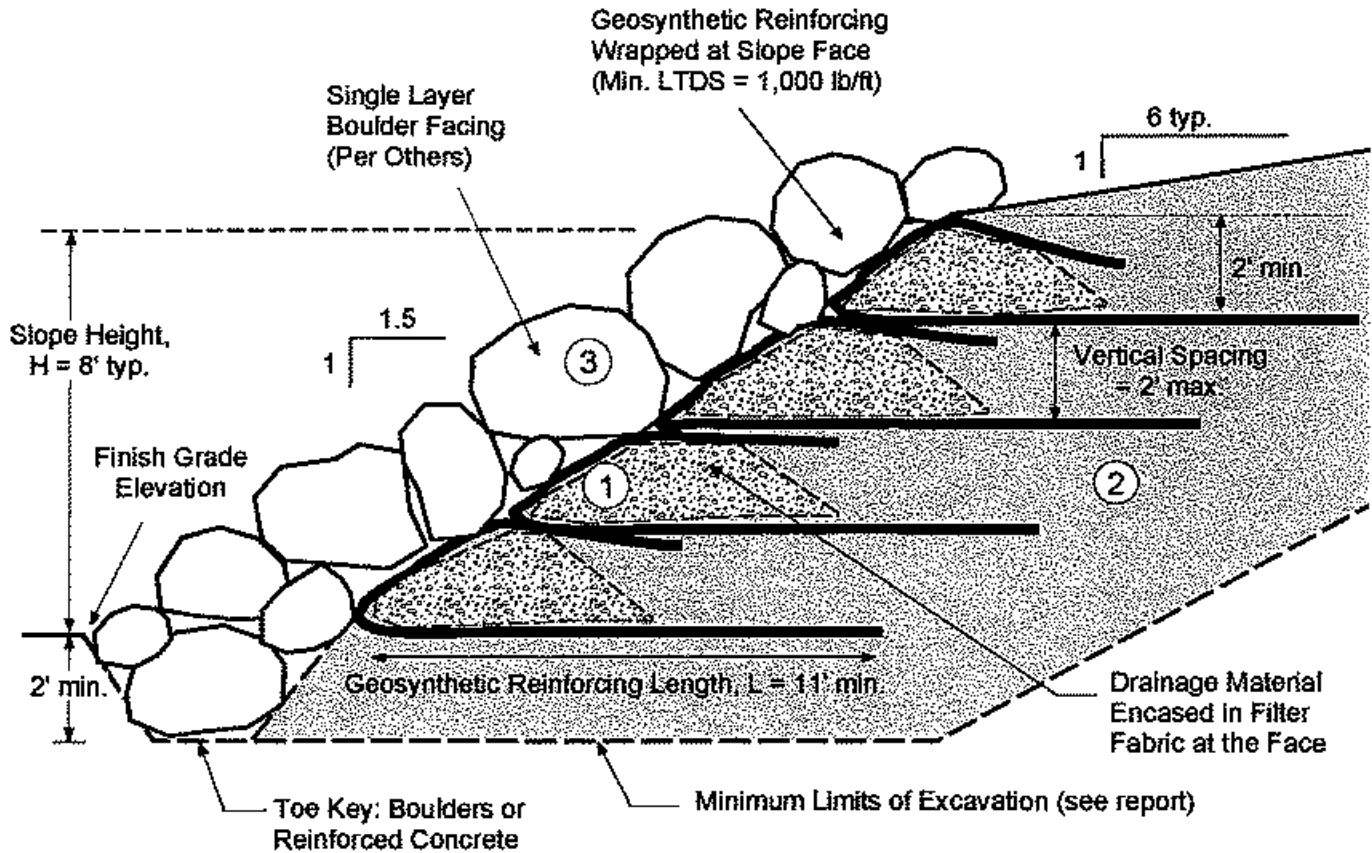

Notes:

- ① Wrap geosynthetic reinforcing layers with 3' min. overlap. Include drainage material encased in filter fabric within the geosynthetic reinforcing. Use min. 1 cubic foot of drainage material per square foot of slope face.
- ② Backfill should consist of Retaining Wall Backfill (SE>20) per recommendations of report.
- ③ Boulders at slope face should be placed and keyed individually to provide interlocking support for each unit. Boulder facing should be initiated in toe key, and placed progressing from the bottom to top of slope. Boulder facing units should completely cover the slope and exposed geosynthetic reinforcing.

**TYPICAL DETAIL FOR SEDIMENTATION BASIN SLOPES**  
 Los Osos Wastewater Project  
 Los Osos, California

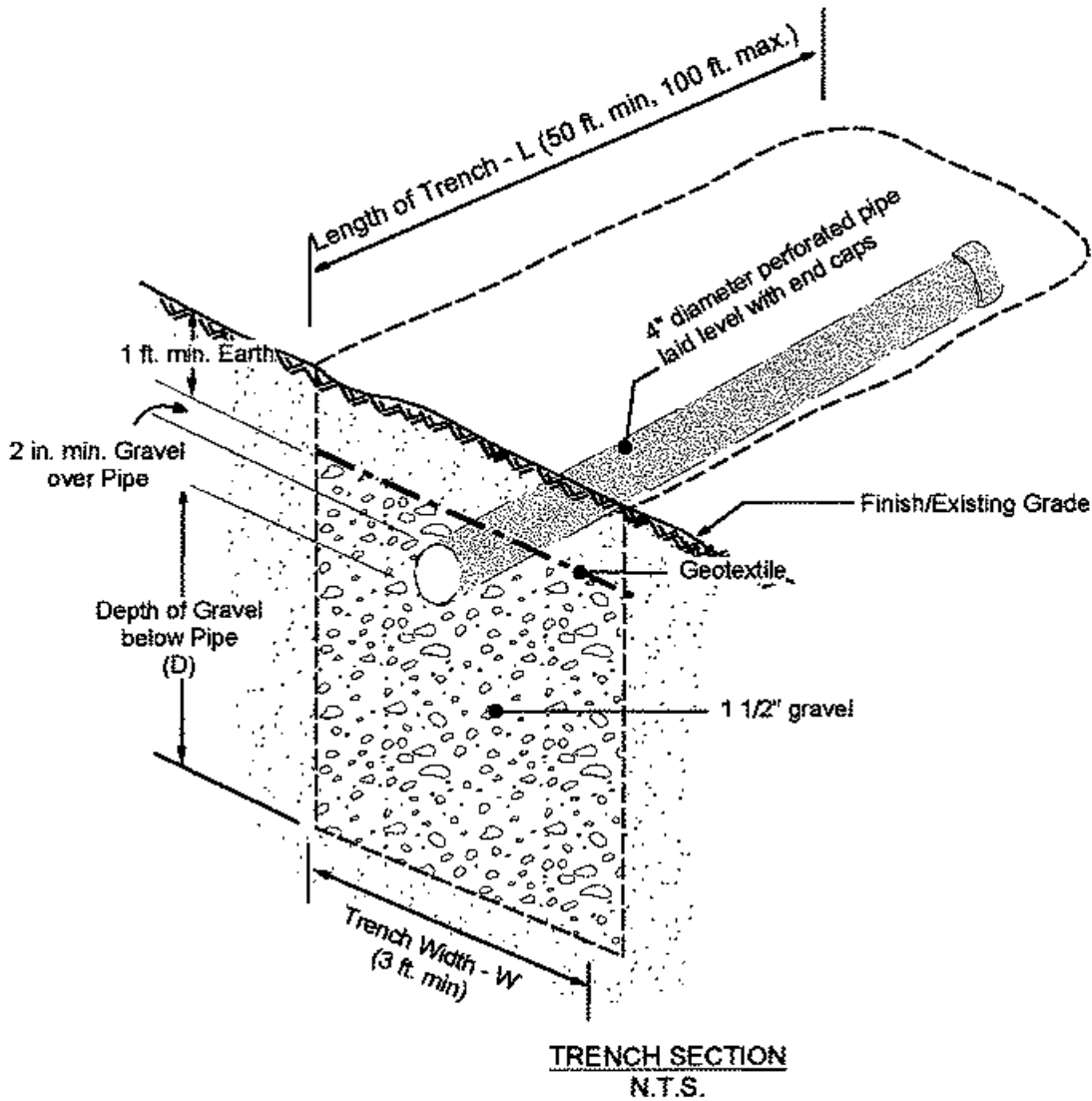
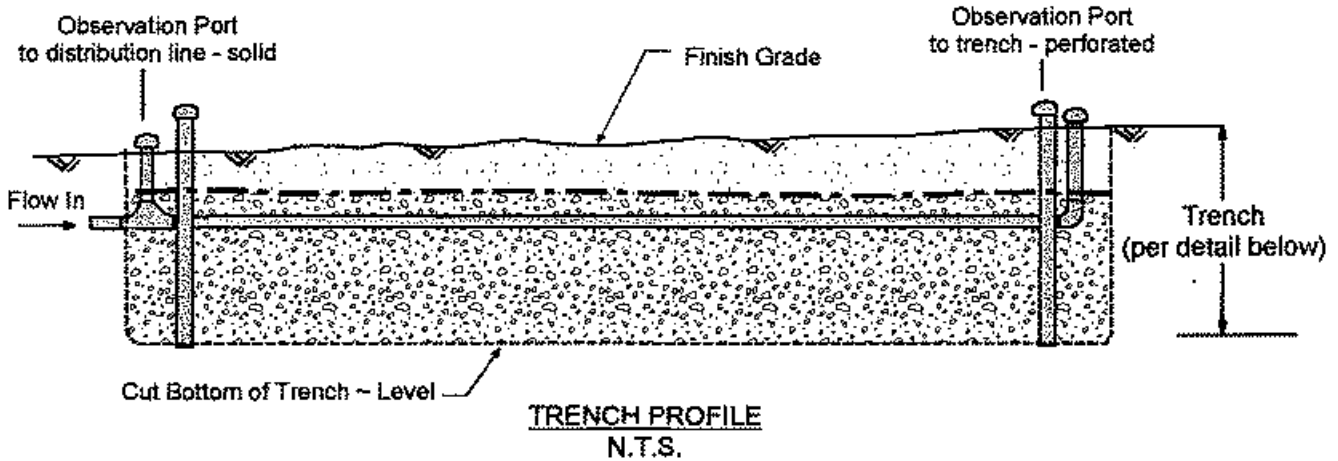

**TYPICAL PERCOLATION LINE DETAIL**  
Los Osos Wastewater Project  
Los Osos, California

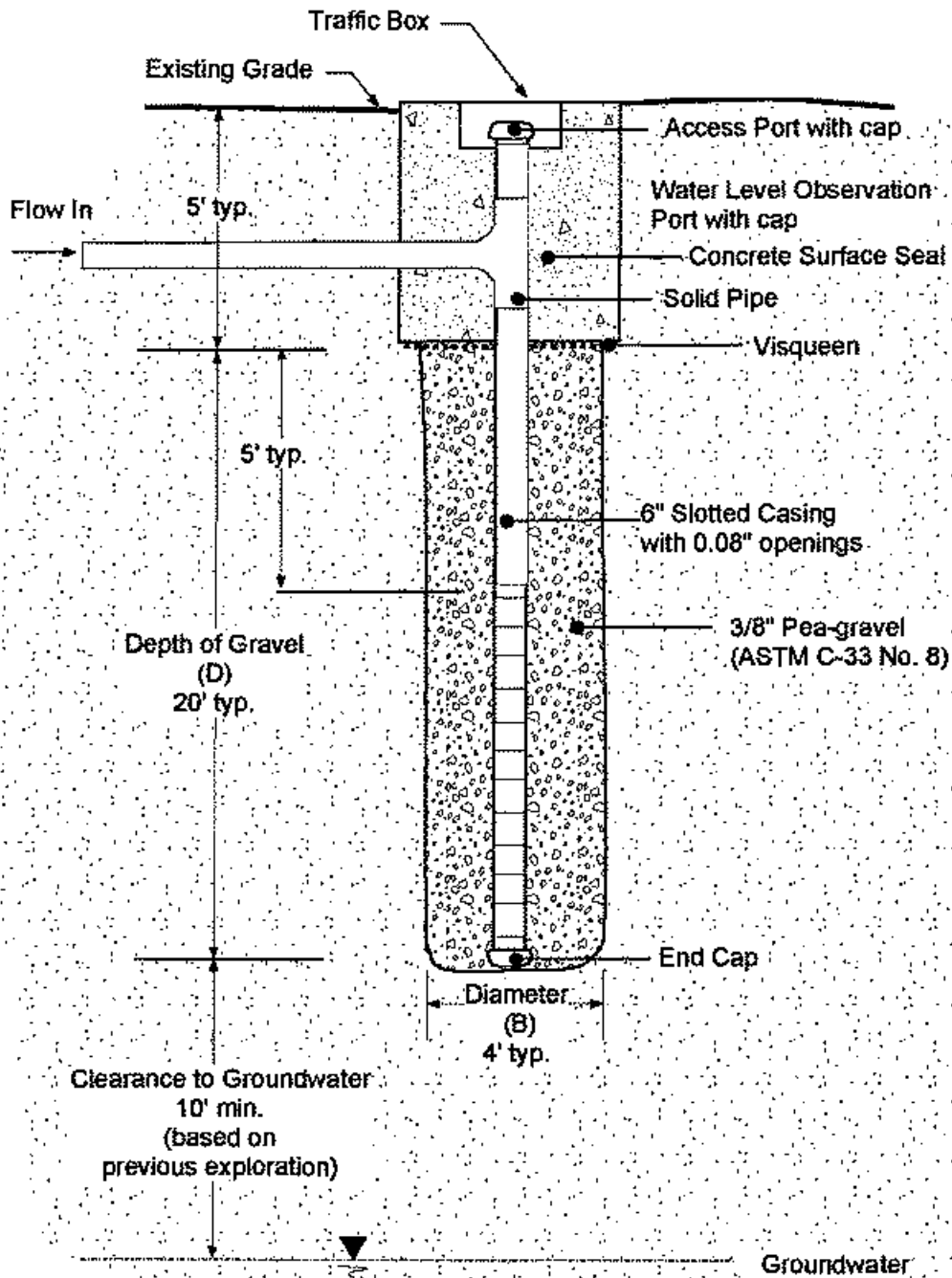

**TYPICAL DRYWELL DETAIL**  
Los Osos Wastewater Project  
San Luis Obispo County, California





APPENDIX A

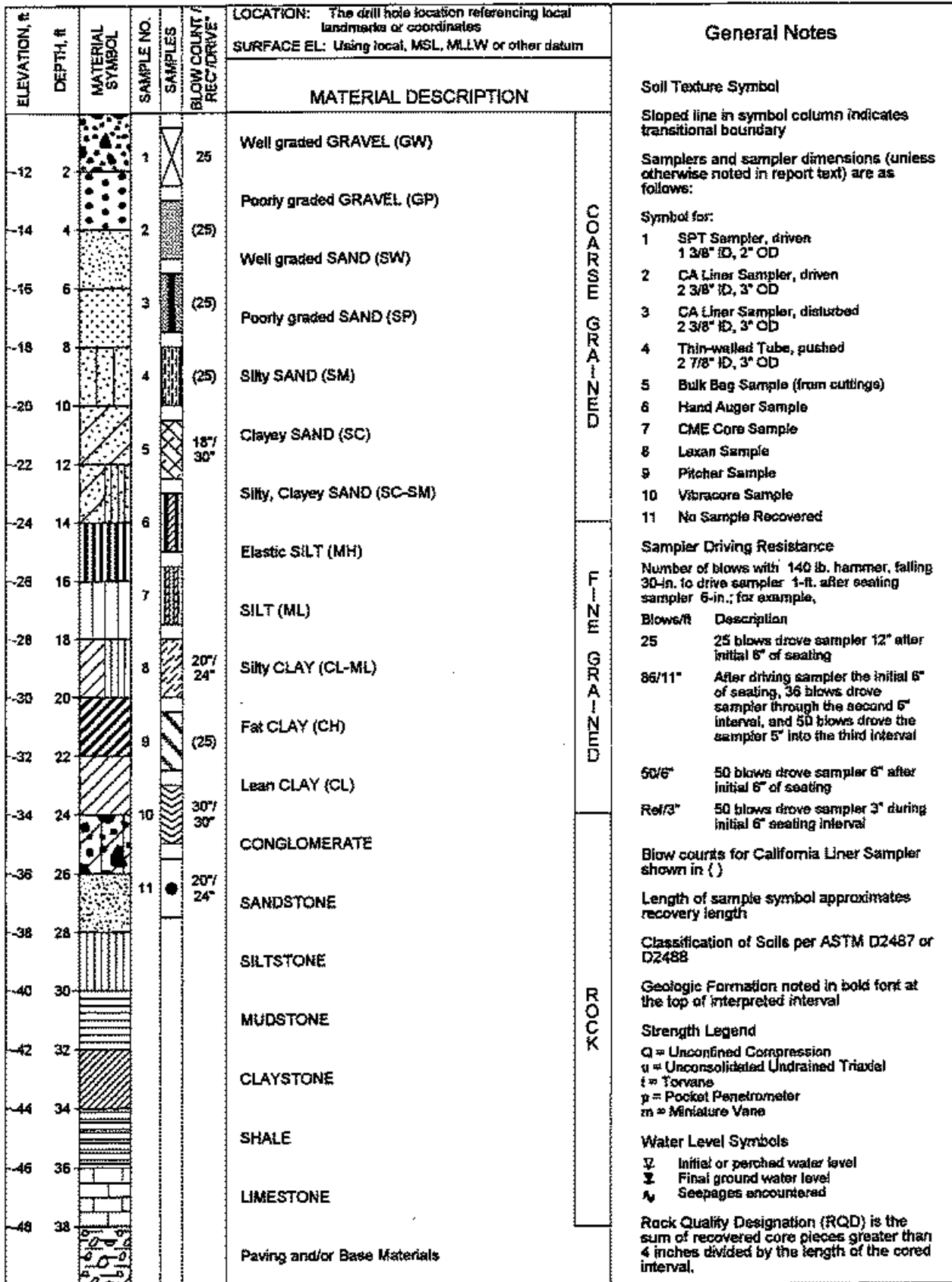

KEY TO TERMS & SYMBOLS USED ON LOGS



ELEVATION, ft	DEPTH, ft	MATERIAL SYMBOL	SAMPLE NO.	SAMPLERS	SAMPLER BLOW COUNT	LOCATION: Intersection of 4th St., and Santa Lucia Ave. SURFACE EL: 20.0 ft +/- (rel. MSL datum)	UNIT WET WEIGHT, pcf	UNIT DRY WEIGHT, pcf	WATER CONTENT, %	% PASSING #200 SIEVE	LIQUID LIMIT, %	PLASTICITY INDEX, %	UNDRAINED SHEAR STRENGTH, S <sub>u</sub> , ksf	
		<b>MATERIAL DESCRIPTION</b>												
-16	2		1		(11)	DUNE SAND DEPOSITS (Qs) Silty fine SAND (SM): loose, brown to dark brown, dry	103	101	3					
-16	4		2		11	Poorly graded SAND (SP): medium dense, red-yellow, moist			3	1				
-14	6		A											
-12	8		3		(37)		131	127	4					
-10	10													
-8	12													
-6	14		4		18	- wet below 13.5'								
-4	16													
-2	18													
0	20		5		(18)	- Water added to augers to reduce the potential for sand to flow up into augers	132	108	22					
-2	22					ESTUARINE DEPOSITS (Qoe) Sand with clay (SP-SC): medium dense, light brown with dark orange iron oxide stains, wet, with lenses of lean CLAY (CL)								
-4	24		6		(32)		128	106	21					
-6	26													
-8	28													
-10	30		7		5	- loose								
-12	32													
-14	34		8		(18)	Silty SAND (SM): medium dense, gray to dark gray, wet, with lean CLAY (CL) pockets			25					
-16	36													
-18	38													
-20	40		9		15									
-22	42					Hole caved below 12 feet after augers were removed.								
-24	44													
-26	46													
-28	48													
-30	50													

COMPLETION DEPTH: 40.5 ft  
DEPTH TO WATER: 13.5 ft  
BACKFILLED WITH: Slurry  
DRILLING DATE: August 11, 2003

DRILLING METHOD: 8-in. dia. Hollow Stem Auger  
HAMMER TYPE: Automatic Trip  
DRILLED BY: S/G Testing  
LOGGED BY: NJDerbridge  
CHECKED BY: JDBlanchar

The log and data presented are a simplification of actual conditions encountered at the time of drilling at the drilled location. Subsurface conditions may differ at other locations and with the passage of time.

**LOG OF DRILL HOLE NO. DH-401**  
Los Osos Wastewater Project  
Los Osos, California



ELEVATION, ft	DEPTH, ft	MATERIAL SYMBOL	SAMPLE NO.	SAMPLERS	SAMPLER BLOW COUNT	LOCATION: 8th St., 200' north of Santa Ysabel Ave. SURFACE EL: 28.0 ft +/- (rel. MSL datum)	UNIT WET WEIGHT, pcf	UNIT DRY WEIGHT, pcf	WATER CONTENT, %	% PASSING #200 SIEVE	LIQUID LIMIT, %	PLASTICITY INDEX, %	UNDRAINED SHEAR STRENGTH, S <sub>u</sub> , ksf
<b>MATERIAL DESCRIPTION</b>													
28	2					<b>DUNE SAND DEPOSITS (Gs)</b> Silty SAND (SM): loose, to medium dense, red-brown, dry							
24	4		1	X	14								
23	6												
20	8												
18	10		2		(29)	Poorly graded SAND (SP): medium dense, red-yellow, moist	108	106	2				
16	12												
14	14		3	X	18				7	2			
12	16												
10	18												
6	20	4		(38)	- wet below 18', brown	131	109	20					
4	22												
2	24	5	X	29	- Water added to augers to reduce the potential for sand to flow up into augers								
0	26												
0	28	6	X	28	- yellow-brown								
2	30												
4	32												
6	34	7	X	28									
8	36												
10	38												
12	40	8	X	38	- dense								
14	42				Hole caved below 18' after augers were removed.								
16	44												
18	46												
20	48												
22	50												

COMPLETION DEPTH: 40.5 ft  
DEPTH TO WATER: 19 ft  
BACKFILLED WITH: Slurry  
DRILLING DATE: August 11, 2003

DRILLING METHOD: 8-in. dia. Hollow Stem Auger  
HAMMER TYPE: Automatic Trip  
DRILLED BY: S/G Testing  
LOGGED BY: NJDerbidge  
CHECKED BY: JDBianchard

The log and data presented are a simplification of actual conditions encountered at the time of drilling at the drilled location. Subsurface conditions may differ at other locations and with the passage of time.

**LOG OF DRILL HOLE NO. DH-402**  
Los Osos Wastewater Project  
Los Osos, California



ELEVATION, ft	DEPTH, ft	MATERIAL SYMBOL	SAMPLE NO.	SAMPLERS	SAMPLER BLOW COUNT	LOCATION: 13th St., 200' north of Santa Ysabel Ave. SURFACE EL: 81.5 ft +/- (rel. MSL datum)	UNIT WET WEIGHT, pcf	UNIT DRY WEIGHT, pcf	WATER CONTENT, %	% PASSING #200 SIEVE	LIQUID LIMIT, %	PLASTICITY INDEX, %	UNDRAINED SHEAR STRENGTH, S <sub>v</sub> , ksf	
MATERIAL DESCRIPTION														
80	2	ARTIFICIAL FILL (af)	1		(21)	3.25" Asphalt concrete over 8" of base consisting of silty SAND (SM): dense, light brown, dry	108	106	2					
78	4	DUNE SAND DEPOSITS (Qs)	2		13	Sand with silt (SP-SM): medium dense, red-brown, dry, fine								
76	6													
74	8													
72	10	Poorly graded SAND (SP): medium dense, red-yellow, moist	3		(26)		107	104	3					
70	12		A											
68	14													
66	16		4		19									
64	18													
62	20	- dense, light brown	5		(49)		108	103	5					
60	22													
58	24		6		31									
56	26													
54	28													
52	30	- medium dense	7		(40)									
50	32													
48	34		8		30									
46	36													
44	38													
42	40	- very dense, wet	9		(85)									
40	42	Hole caved below 37 feet after augers were removed.												
38	44													
36	46													
34	48													
32	50													

COMPLETION DEPTH: 40.5 ft  
 DEPTH TO WATER: 39 ft  
 BACKFILLED WITH: Silty/concrete cap  
 DRILLING DATE: August 11, 2003

DRILLING METHOD: 8-in. dia. Hollow Stem Auger  
 HAMMER TYPE: Automatic Trip  
 DRILLED BY: S/G Testing  
 LOGGED BY: NjDerbidge  
 CHECKED BY: JDBlanchar

The log and data presented are a simplification of actual conditions encountered at the time of drilling at the drilled location. Subsurface conditions may differ at other locations and with the passage of time.

**LOG OF DRILL HOLE NO. DH-403**  
 Los Osos Wastewater Project  
 Los Osos, California



ELEVATION, ft	DEPTH, ft	MATERIAL SYMBOL	SAMPLE NO.	SAMPLERS	SAMPLER BLOW COUNT	LOCATION: Paso Robles Ave., 40' east of 3rd St. SURFACE EL: 20.0 ft +/- (rel. MSL datum)	UNIT WET WEIGHT, pcf	UNIT DRY WEIGHT, pcf	WATER CONTENT, %	% PASSING #200 SIEVE	LIQUID LIMIT, %	PLASTICITY INDEX, %	UNDRAINED SHEAR STRENGTH, S <sub>u</sub> , ksf
						<b>DUNE SAND DEPOSITS (Gs)</b> Poorly graded SAND with silt (SP-SM): loose, to medium dense, red-yellow, dry - moist							
-16	2		1		(15)		104	103	2				
-16	4		2		11			100	8				
-14	6		3		(21)		111	108	5				
-10	10		4		23	- wet			18	8			
-6	14		5		(49)	- dense, water added to augers to reduce the potential for sand to flow up into augers	130	107	21				
-2	18												
0	20		6		47								
-2	22												
-4	24		7		(50/5)								
-6	26												
-6	28												
-10	30		8		n/a								
-12	32												
-14	34					Hole terminated at 34 feet due to sand flowing up into augers and binding between center bit and augers. Hole caved below 12 feet after augers were removed.							
-16	36												
-18	38												
-20	40												
-22	42												
-24	44												
-26	46												
-28	48												
-30	50												

COMPLETION DEPTH: 34.0 ft  
DEPTH TO WATER: 9.5 ft  
BACKFILLED WITH: Slurry  
DRILLING DATE: August 12, 2003

DRILLING METHOD: 8-in. dia. Hollow Stem Auger  
HAMMER TYPE: Automatic Trip  
DRILLED BY: S/G Testing  
LOGGED BY: NJDenbidge  
CHECKED BY: JDBlanchar

The log and data presented are a simplification of actual conditions encountered at the time of drilling at the drilled location. Subsurface conditions may differ at other locations and with the passage of time.

**LOG OF DRILL HOLE NO. DH-404**  
Los Osos Wastewater Project  
Los Osos, California



ELEVATION, ft	DEPTH, ft	MATERIAL SYMBOL	SAMPLE NO.	SAMPLERS	SAMPLER BLOW COUNT	LOCATION: Maintenance yard at the Intersection of Nipomo Ave. and South Bay Blvd. SURFACE EL: 107.0 ft +/- (rel. MSL datum)	UNIT WET WEIGHT, pcf	UNIT DRY WEIGHT, pcf	WATER CONTENT, %	% PASSING #200 SIEVE	LIQUID LIMIT, %	PLASTICITY INDEX, %	UNDRAINED SHEAR STRENGTH, $S_u$ , ksf		
MATERIAL DESCRIPTION															
108	2	[Dotted pattern]	1	[Sampler symbol]	(14)	DUNE SAND DEPOSITS (Qs) Poorly graded SAND (SP): loose, to medium dense, red-yellow, dry, fine  - moist	106	102	4						
104	4		A		10				100	7					
102	6		2												
100	8		3		(24)				109	104	5				
98	10		4		17										
96	12														
94	14														
92	16		5		(46)				116	108	6				
90	18														
88	20														
86	22														
84	24	[Dotted pattern]	7	[Sampler symbol]	(47)	PASO ROBLES FORMATION (Qtp) Poorly graded SAND (SP): dense, red-yellow, wet									
82	26														
80	28														
78	30		8		88/11										
76	32														
74	34														
72	36														
70	38														
68	40	[Diagonal lines]	10	[Sampler symbol]	(31)	Sandy lean CLAY with gravel (CL): stiff, to very stiff, red-yellow, wet Hole caved below 25 feet after augers were removed.									
66	42														
64	44														
62	46														
60	48														
58	50														
56															

COMPLETION DEPTH: 40.5 ft  
DEPTH TO WATER: 23.5 ft  
BACKFILLED WITH: Slurry  
DRILLING DATE: August 12, 2003

DRILLING METHOD: 8-in. dia. Hollow Stem Auger  
HAMMER TYPE: Automatic Trip  
DRILLED BY: S/G Testing  
LOGGED BY: NJDerbidge  
CHECKED BY: JDBlanchar

The log and data presented are a simplification of actual conditions encountered at the time of drilling at the drilled location. Subsurface conditions may differ at other locations and with the passage of time.

**LOG OF DRILL HOLE NO. DH-405**  
Los Osos Wastewater Project  
Los Osos, California



ELEVATION, ft	DEPTH, ft	MATERIAL SYMBOL	SAMPLE NO.	SAMPLERS	SAMPLER BLOW COUNT	LOCATION: Intersection of Santa Ynez Ave., and Mountain View Ave. SURFACE EL: 100.0 ft +/- (rel. MSL datum)	UNIT WET WEIGHT, pcf	UNIT DRY WEIGHT, pcf	WATER CONTENT, %	% PASSING #200 SIEVE	LIQUID LIMIT, %	PLASTICITY INDEX, %	UNDRAINED SHEAR STRENGTH, $s_u$ , ksf
						<b>MATERIAL DESCRIPTION</b>							
						ARTIFICIAL FILL (af) 3" Asphalt concrete over 6" of aggregate base							
						DUNE SAND DEPOSITS (Qs) Silty SAND (SM): loose, red-brown, moist, fine:	108	105	4				
						Sand with silt (SP-SM): loose, light brown, moist, fine:							
						- medium dense, with iron oxide stains	131	119	9				
						- red-yellow, with black specs							
						PASO ROBLES FORMATION (Qtp) Clayey SAND (SC): very dense, red-brown, moist, with black specs, sand partings	118	107	11	25			
						Sandy lean CLAY (CL): very stiff, red-brown, moist, with sand partings			20		34	27	
						- hard, with layers of SAND with clay and gravel (SP-SC)	140	122	15	11			
						- with layers of SAND with gravel (SP)			18		39	19	

COMPLETION DEPTH: 40.5 ft  
DEPTH TO WATER: Not Encountered  
BACKFILLED WITH: Slurry  
DRILLING DATE: August 12, 2003

DRILLING METHOD: 8-in. dia. Hollow Stem Auger  
HAMMER TYPE: Automatic Trip  
DRILLED BY: S/G Testing  
LOGGED BY: NJDerbidge  
CHECKED BY: JDBlanchar

The log and data presented are a simplification of actual conditions encountered at the time of drilling at the drilled location. Subsurface conditions may differ at other locations and with the passage of time.

**LOG OF DRILL HOLE NO. DH-406**  
Los Osos Wastewater Project  
Los Osos, California





ELEVATION, ft	DEPTH, ft	MATERIAL SYMBOL	SAMPLE NO.	SAMPLERS	SAMPLER BLOW COUNT	LOCATION: Intersection of Bay Oaks Dr., and Crest Ave. SURFACE EL: 182.0 ft +/- (rel. MSL datum)	UNIT WET WEIGHT, pcf	UNIT DRY WEIGHT, pcf	WATER CONTENT, %	% PASSING #200 SIEVE	LIQUID LIMIT, %	PLASTICITY INDEX, %	UNDRAINED SHEAR STRENGTH, $s_u$ , ksf
						<b>MATERIAL DESCRIPTION</b>							
						ARTIFICIAL FILL (af) 4" Asphalt concrete over 8" aggregate base							
						DUNE SAND DEPOSITS (Gs) Poorly graded SAND (SP): medium dense, red-yellow, moist							
-180	2	[Symbol]	1	[Symbol]	(24)		108	104	2				
-178	4	[Symbol]	2	[Symbol]	15								
-176	6	[Symbol]											
-174	8	[Symbol]											
-172	10	[Symbol]	3	[Symbol]	(29)		108	103	4				
-170	12	[Symbol]	A	[Symbol]									
-168	14	[Symbol]	4	[Symbol]	17	- light brown							
-166	16	[Symbol]											
-164	18	[Symbol]											
-162	20	[Symbol]	5	[Symbol]	(30)		107	101	6				
-180	22					Hole caved below 18.5 feet after augers were removed.							
-158	24												
-156	26												
-154	28												
-152	30												
-150	32												
-148	34												
-146	36												
-144	38												
-142	40												
-140	42												
-138	44												
-136	46												
-134	48												
-132	50												

COMPLETION DEPTH: 20.5 ft  
 DEPTH TO WATER: Not Encountered  
 BACKFILLED WITH: Cuttings/concrete cap  
 DRILLING DATE: August 13, 2003

DRILLING METHOD: 8-in. dia. Hollow Stem Auger  
 HAMMER TYPE: Automatic Trip  
 DRILLED BY: S/G Testing  
 LOGGED BY: NJDerbidge  
 CHECKED BY: JDBlanchar

The log and data presented are a simplification of actual conditions encountered at the time of drilling at the drilled location. Subsurface conditions may differ at other sections and with the passage of time.

**LOG OF DRILL HOLE NO. DH-408**  
 Los Osos Wastewater Project  
 Los Osos, California



ELEVATION, R	DEPTH, R	MATERIAL SYMBOL	SAMPLE NO.	SAMPLERS	SAMPLER BLOW COUNT	LOCATION: Bay View Heights Dr., 75' north of Bay Oaks Dr. SURFACE EL: 136.0 R +/- (rel. MSL datum)	UNIT WET WEIGHT, pcf	UNIT DRY WEIGHT, pcf	WATER CONTENT, %	% PASSING #200 SIEVE	LIQUID LIMIT, %	PLASTICITY INDEX, %	UNDRAINED SHEAR STRENGTH, S <sub>u</sub> , ksf
MATERIAL DESCRIPTION													
134	2		1		10	ARTIFICIAL FILL (af) 4" Asphalt concrete over 20" aggregate base consisting of lean CLAY with gravel (CL); very stiff, brown, moist			5	2			
132	4		2		(20)	DUNE SAND DEPOSITS (Gs) Poorly graded SAND (SP); medium dense, red-brown, moist, fine	108	103	5				
128	8												
128	10		3		19	- red-yellow							
124	12		A										
122	14		4		(48)		108	103	4				
120	16												
118	18												
118	20		5		46								
114	22					Hole caved below 18.5 feet after augers were removed.							
112	24												
110	26												
108	28												
106	30												
104	32												
102	34												
100	36												
98	38												
96	40												
94	42												
92	44												
90	46												
88	48												
86	50												

COMPLETION DEPTH: 20.5 ft  
 DEPTH TO WATER: Not Encountered  
 BACKFILLED WITH: Cuttings/concrete cap  
 DRILLING DATE: August 13, 2003

DRILLING METHOD: 8-in. dia. Hollow Stem Auger  
 HAMMER TYPE: Automatic Trip  
 DRILLED BY: S/G Teeling  
 LOGGED BY: NJDerbidge  
 CHECKED BY: JDBlanchar

The log and data presented are a simplification of actual conditions encountered at the time of drilling at the drilled location. Subsurface conditions may differ at other locations and with the passage of time.

**LOG OF DRILL HOLE NO. DH-409**  
 Los Osos Wastewater Project  
 Los Osos, California



ELEVATION, ft	DEPTH, ft	MATERIAL SYMBOL	SAMPLE NO.	SAMPLERS	SAMPLER BLOW COUNT	LOCATION: Intersection of Lilac Dr. and Palisades Ave. SURFACE EL: 145.5 ft +/- (rel. MSL datum)	UNIT WET WEIGHT, pcf	UNIT DRY WEIGHT, pcf	WATER CONTENT, %	% PASSING #200 SIEVE	LIQUID LIMIT, %	PLASTICITY INDEX, %	UNDRAINED SHEAR STRENGTH, S <sub>u</sub> , ksf
						<b>MATERIAL DESCRIPTION</b>							
144	2		1		18	<b>ARTIFICIAL FILL (af)</b> 4" Asphalt concrete over 16" aggregate base							
142	4				(24)	<b>DUNE SAND DEPOSITS</b> Silty SAND (SM): medium dense, red-brown, dry, fine	101	98	3				
140	6		2										
138	8												
136	10		3		23	SAND with silt (SP-SM): medium dense, yellow-brown, moist, fine							
134	12		A										
132	14												
130	16		4		(44)	Poorly-graded SAND (SP): medium dense, yellow-brown, moist, with few SILT (ML) pockets	107	104	3				
128	18												
126	20		5		38	- dense							
124	22					Hole cave below 16.5 feet after augers were removed.							
122	24												
120	26												
118	28												
116	30												
114	32												
112	34												
110	36												
108	38												
106	40												
104	42												
102	44												
100	46												
98	48												
96	50												
94													

COMPLETION DEPTH: 20.5 ft  
 DEPTH TO WATER: Not Encountered  
 BACKFILLED WITH: Cuttings/concrete cap  
 DRILLING DATE: August 13, 2003

DRILLING METHOD: 8-in. dia. Hollow Stem Auger  
 HAMMER TYPE: Automatic Trip  
 DRILLED BY: S/G Testing  
 LOGGED BY: NJDerbidge  
 CHECKED BY: JDBlanchar

The log and data presented are a simplification of actual conditions encountered at the time of drilling at the drilled location. Subsurface conditions may differ at other locations and with the passage of time.

**LOG OF DRILL HOLE NO. DH-410**  
 Los Osos Wastewater Project  
 Los Osos, California



ELEVATION, ft	DEPTH, ft	MATERIAL SYMBOL	SAMPLE NO.	SAMPLERS	SAMPLER BLOW COUNT	LOCATION: Lilac Dr., 50' east of Broderson Ave. SURFACE EL: 143.0 ft +/- (rel. MSL datum)	UNIT WET WEIGHT, pcf	UNIT DRY WEIGHT, pcf	WATER CONTENT, %	% PASSING #200 SIEVE	LIQUID LIMIT, %	PLASTICITY INDEX, %	UNDRAINED SHEAR STRENGTH, $S_u$ , ksf
						<b>MATERIAL DESCRIPTION</b>							
142	2		1		(13)	<b>ARTIFICIAL FILL (af)</b> 4.5" Asphalt concrete over 10.5" aggregate base	99	97	2	3			
140	4		2		8	<b>DUNE SAND DEPOSITS (Qs)</b> Poorly graded SAND (SP): loose to medium dense, red-brown, dry			2				
138	6		A			- light brown							
138	8					- red-yellow							
134	10		3		(32)		106	103	3				
132	12												
130	14		4		20								
128	16												
128	18												
124	20		5		21								
122	22												
120	24												
116	28												
116	28												
114	30												
112	32												
110	34												
108	36												
108	38												
104	40												
102	42												
100	44												
98	46												
96	48												
94	48												
94	50												
92													

COMPLETION DEPTH: 20.0 ft  
 DEPTH TO WATER: Not Encountered  
 BACKFILLED WITH: Cuttings/concrete cap  
 DRILLING DATE: August 13, 2003

DRILLING METHOD: 8-in. dia. Hollow Stem Auger  
 HAMMER TYPE: Automatic Trip  
 DRILLED BY: S/G Testing  
 LOGGED BY: NJDerbidge  
 CHECKED BY: JDBlanchar

The log and data presented are a simplification of actual conditions encountered at the time of drilling at the drilled location. Subsurface conditions may differ at other locations and with the passage of time.

**LOG OF DRILL HOLE NO. DH-411**  
 Los Osos Wastewater Project  
 Los Osos, California



ELEVATION, ft	DEPTH, ft	MATERIAL SYMBOL	SAMPLE NO.	SAMPLERS	SAMPLER BLOW COUNT	LOCATION: intersection of Santa Maria Ave and 18th St. SURFACE EL: 120.0 ft +/- (rel. MSL datum)	PIEZOMETER	UNIT WET WEIGHT, pcf	UNIT DRY WEIGHT, pcf	WATER CONTENT, %	% PASSING #200 SIEVE	LIQUID LIMIT, %	PLASTICITY INDEX, %	UNDRAINED SHEAR STRENGTH, $s_u$ , ksf
						<b>MATERIAL DESCRIPTION</b>								
-118	2	[Symbol: Gravel/Aggregate]				ARTIFICIAL FILL (af) Gravel, Aggregate base, and pieces of asphalt concrete.					1			
-118	4	[Symbol: Sand]				DUNE SAND DEPOSITS (Ds) SAND with silt (SP-SM): medium dense, light brown, dry, moist below 3'								
-114	6	[Symbol: Sand]				Poorly-graded SAND (SP): medium dense, light brown, moist, fine								
-112	8	[Symbol: Sand]												
-110	10	[Symbol: Sand]												
-108	12	[Symbol: Sand]												
-108	14	[Symbol: Sand]												
-104	16	[Symbol: Sand]												
-102	18	[Symbol: Sand]												
-100	20	[Symbol: Sand]												
-98	22	[Symbol: Sand]												
-96	24	[Symbol: Sand]												
-94	26	[Symbol: Sand]												
-92	28					Note: Hole reamed to 4' diameter to a depth of 23'. Drywell installed in hole.								
-90	30													
-88	32													
-86	34													
-84	36													
-82	38													
-80	40													
-78	42													
-76	44													
-74	46													
-72	48													
-70	50													

COMPLETION DEPTH: 26.0 ft  
 DEPTH TO WATER: Not Encountered  
 BACKFILLED WITH: drywell  
 DRILLING DATE: September 25, 2003

DRILLING METHOD: 36-in. dia. Bucket Auger  
 HAMMER TYPE: none  
 DRILLED BY: Tri-Valley Drilling  
 LOGGED BY: CLLovato  
 CHECKED BY: JDBlanchar

The log and data presented are a simplification of actual conditions encountered at the time of drilling at the drilled location. Subsurface conditions may differ at other locations and with the passage of time.

**LOG OF NO. DW-1**  
 Los Osos Wastewater Project  
 Los Osos, California



ELEVATION, ft	DEPTH, ft	MATERIAL SYMBOL	SAMPLE NO	SAMPLERS	SAMPLER BLOW COUNT	LOCATION: South side of Lupine, 50' west of Donna Ave. SURFACE EL: 13.0 ft +/- (ref. MSL datum)	UNIT WET WEIGHT, pcf	UNIT DRY WEIGHT, pcf	WATER CONTENT, %	% PASSING #200 SIEVE	LIQUID LIMIT, %	PLASTICITY INDEX, %	UNDRAINED SHEAR STRENGTH, S <sub>u</sub> , ksf
12	2	[Symbol]	1	[Symbol]		ARTIFICIAL FILL (af)/DUNE SAND DEPOSITS (Gs) SAND with silt (SP-SM): loose to medium dense, light brown, dry, with fine roots		97	9				
10	4	[Symbol]	2	[Symbol]		ALLUVIUM (Qa)/ESTUARINE DEPOSITS (Qoe) SAND with silt (SP-SM): medium dense, red-brown, moist, with fine roots	105	102	2				
8	6	[Symbol]				Sand with silt (SP-SM): medium dense, light gray, wet							
6	8	[Symbol]	3	[Symbol]		Fat CLAY (CH): medium stiff, light gray with brown mottles, moist to wet			32	67	35		
4	10												
2	12												
0	14												
-2	16												
-4	18												
-6	20												
-8	22												
-10	24												
-12	26												
-14	28												
-16	30												
-18	32												
-20	34												
-22	36												
-24	38												
-26	40												
-28	42												
-30	44												
-32	46												
-34	48												
-36	50												

COMPLETION DEPTH: 9.0 ft  
DEPTH TO WATER: 5.5 ft  
BACKFILLED WITH: Cuttings  
DRILLING DATE: August 7, 2003

DRILLING METHOD: 4-in. dia. Hand Auger  
HAMMER TYPE: Hand  
DRILLED BY: Fugro  
LOGGED BY: CLovato  
CHECKED BY: JDBlanchar

The log and data presented are a simplification of actual conditions encountered at the time of drilling at the drilled location. Subsurface conditions may differ at other locations and with the passage of time.



ELEVATION, ft	DEPTH, ft	MATERIAL SYMBOL	SAMPLE NO.	SAMPLERS	SAMPLER BLOW COUNT	LOCATION: 65' west of 3rd St., 300' south of El Morro Ave. SURFACE EL: 12.5 ft +/- (ref. MSL datum)	UNIT WET WEIGHT, pcf	UNIT DRY WEIGHT, pcf	WATER CONTENT, %	% PASSING #200 SIEVE	LIQUID LIMIT, %	PLASTICITY INDEX, %	UNDRAINED SHEAR STRENGTH, $s_u$ , ksf
MATERIAL DESCRIPTION													
12	2	[Symbol]				ARTIFICIAL FILL (af) Silty SAND with gravel (SM): medium dense, light brown, moist							
10	4	[Symbol]	A	[Symbol]		ALLUVIUM (Qa)/ESTUARINE DEPOSITS (Qoe) Poorly graded SAND (SP): loose to medium dense, light brown, wet - seepage							
8	6	[Symbol]											
6	8	[Symbol]											
4	10	[Symbol]											
2	12	[Symbol]											
0	14	[Symbol]											
-2	16	[Symbol]											
-4	18	[Symbol]											
-6	20	[Symbol]											
-8	22	[Symbol]											
-10	24	[Symbol]											
-12	26	[Symbol]											
-14	28	[Symbol]											
-16	30	[Symbol]											
-18	32	[Symbol]											
-20	34	[Symbol]											
-22	36	[Symbol]											
-24	38	[Symbol]											
-26	40	[Symbol]											
-28	42	[Symbol]											
-30	44	[Symbol]											
-32	46	[Symbol]											
-34	48	[Symbol]											
-36	50	[Symbol]											

COMPLETION DEPTH: 12.5 ft  
DEPTH TO WATER: 4 ft  
BACKFILLED WITH: Cuttings  
DRILLING DATE: August 8, 2003

DRILLING METHOD: 4-in. dia. Hand Auger  
HAMMER TYPE: Hand  
DRILLED BY: Fugro  
LOGGED BY: Clovato  
CHECKED BY: JDBlanchar

The log and data presented are a simplification of actual conditions encountered at the time of drilling at the drilled location. Subsurface conditions may differ at other locations and with the passage of time.

**LOG OF NO. HA-402**  
Los Osos Wastewater Project  
Los Osos, California



ELEVATION, ft	DEPTH, ft	MATERIAL SYMBOL	SAMPLE NO.	SAMPLERS	SAMPLER BLOW COUNT	LOCATION: 155' south of El Morro Ave., 90' east of 8th St. SURFACE EL: 26.0 ft +/- (rel. MSL datum)	UNIT WET WEIGHT, pcf	UNIT DRY WEIGHT, pcf	WATER CONTENT, %	% PASSING #200 SIEVE	LIQUID LIMIT, %	PLASTICITY INDEX, %	UNDRAINED SHEAR STRENGTH, $S_u$ , ksf
MATERIAL DESCRIPTION													
-24	2		A		1	ARTIFICIAL FILL (af) Mix of silty SAND (SM) and GRAVEL (GP)	109	98	6				
-22	4					DUNE SAND DEPOSITS (Qs) SAND with silt (SP-SM): medium dense, moderate brown, moist							
-20	6					- dark gray, wet - caving and sloughing noted							
-18	8												
-16	10												
-14	12												
-12	14												
-10	16												
-8	18												
-6	20												
-4	22												
-2	24												
0	26												
-2	28												
-4	30												
-6	32												
-8	34												
-10	38												
-12	36												
-14	40												
-16	42												
-18	44												
-20	46												
-22	48												
-24	50												

COMPLETION DEPTH: 10.0 ft  
DEPTH TO WATER: 5.5 ft  
BACKFILLED WITH: Cuttings  
DRILLING DATE: August 8, 2003

DRILLING METHOD: 4-in. dia. Hand Auger  
HAMMER TYPE: Hand  
DRILLED BY: Fugro  
LOGGED BY: C Lovato  
CHECKED BY: JDBianchard

The log and data presented are a simplification of actual conditions encountered at the time of drilling at the drilled location. Subsurface conditions may differ at other locations and with the passage of time.





ELEVATION, ft	DEPTH, ft	MATERIAL SYMBOL	SAMPLE NO.	SAMPLERS	SAMPLER BLOW COUNT	LOCATION: Intersection of Santa Maria Ave and 18th St SURFACE EL: 120.0 ft +/- (rel. MSL datum)	DRYWELL	UNIT WET WEIGHT, pcf	UNIT DRY WEIGHT, pcf	WATER CONTENT, %	% PASSING #200 SIEVE	LIQUID LIMIT, %	PLASTICITY INDEX, %	UNDRAINED SHEAR STRENGTH, S <sub>u</sub> , ksf
						<b>MATERIAL DESCRIPTION</b>								
-118	2	[Symbol]				ARTIFICIAL FILL (af) Gravel, Aggregate base, and pieces of asphalt concrete.	[Symbol]				#			
-116	4	[Symbol]				DUNE SAND DEPOSITS (Gs) SAND with silt (SP-SM): medium dense, light brown, dry, moist below 3'	[Symbol]							
-114	6	[Symbol]				Poorly-graded SAND (SP): medium dense, light brown, moist, fine	[Symbol]							
-112	8	[Symbol]					[Symbol]							
-110	10	[Symbol]					[Symbol]							
-108	12	[Symbol]					[Symbol]							
-106	14	[Symbol]					[Symbol]							
-104	16	[Symbol]					[Symbol]							
-102	18	[Symbol]					[Symbol]							
-100	20	[Symbol]					[Symbol]							
-98	22	[Symbol]					[Symbol]							
-96	24	[Symbol]					[Symbol]							
-94	26	[Symbol]					[Symbol]							
-92	28	[Symbol]				Note: Hole reamed to 4' diameter to a depth of 23'. Drywell installed in hole.	[Symbol]							
-90	30	[Symbol]					[Symbol]							
-88	32	[Symbol]					[Symbol]							
-86	34	[Symbol]					[Symbol]							
-84	36	[Symbol]					[Symbol]							
-82	38	[Symbol]					[Symbol]							
-80	40	[Symbol]					[Symbol]							
-78	42	[Symbol]					[Symbol]							
-76	44	[Symbol]					[Symbol]							
-74	46	[Symbol]					[Symbol]							
-72	48	[Symbol]					[Symbol]							
-70	50	[Symbol]					[Symbol]							

COMPLETION DEPTH: 26.0 ft  
DEPTH TO WATER: Not Encountered  
BACKFILLED WITH: drywell  
DRILLING DATE: September 25, 2003

DRILLING METHOD: 36-in. dia. Bucket Auger  
HAMMER TYPE: none  
DRILLED BY: Tri-Valley Drilling  
LOGGED BY: CL Lovato  
CHECKED BY: JDBlanhard

The log and data presented are a simplification of actual conditions encountered at the time of drilling at the listed location. Surface conditions may differ at other locations and with the passage of time.



ELEVATION, R	DEPTH, R	MATERIAL SYMBOL	SAMPLE NO.	SAMPLERS	SAMPLER BLOW COUNT	LOCATION: Intersection of Santa Maria and 18th St 11' north of DW-1. SURFACE EL: 120.0 R +/- (rel. MSL datum)	UNIT WET WEIGHT, pcf	UNIT DRY WEIGHT, pcf	WATER CONTENT, %	% PASSING #200 SIEVE	LIQUID LIMIT, %	PLASTICITY INDEX, %	UNDRAINED SHEAR STRENGTH, S <sub>u</sub> , ksf
						<b>DUNE SAND DEPOSITS (Q<sub>s</sub>)</b> Sand with silt (SP-SM): medium dense, light brown, dry							
-118	2												
-116	4		1	(20)		Grades to poorly-graded SAND (SP): medium dense, light brown, moist - orange brown	110	106	4				
-114	6												
-112	8												
-110	10		2	X	17								
-108	12												
-106	14												
-104	16		3	(40)		- light brown to tan	113	108	4				
-102	18												
-100	20		4	X	29				4	3			
-98	22												
-96	24												
-94	26		5	(56)		- dense, very few pockets of light gray/buff, dry silty SAND (SM) from 24.5 ft to 25 ft	114	108	5				
-92	28												
-90	30		6	X	29	- very few nodules (0.25 inch diameter) of light gray/buff silty SAND (SM) to sandy SILT (ML)							
-88	32												
-86	34												
-84	36		7	(51)			108	102	6				
-82	38												
-80	40		8	X	48				5	3			
-78	42												
-76	44												
-74	46		9	(34)		- with 0.25 inch diameter pockets of sandy SILT (ML) to silty SAND (SM), slightly cemented, light gray/buff	106	103	3				
-72	48												
-70	50		10	X	82				5	3			
						2" steel casing installed; backfilled with native sand.							

COMPLETION DEPTH: 51.0 ft  
DEPTH TO WATER: Not Encountered  
BACKFILLED WITH: Native Materials  
DRILLING DATE: September 26, 2003

DRILLING METHOD: 8-in. dia. Hollow Stem Auger  
HAMMER TYPE: Automatic Trip  
DRILLED BY: S/G Drilling Company  
LOGGED BY: CLlovato  
CHECKED BY: JDBlanchar

The log and data presented are a simplification of actual conditions encountered at the time of drilling at the drilled location. Subsurface conditions may differ at other locations and with the passage of time.

**LOG OF NO. HP-1**  
Los Osos Wastewater Project  
Los Osos, California



ELEVATION, ft	DEPTH, ft	MATERIAL SYMBOL	SAMPLE NO.	SAMPLERS	SAMPLER BLOW COUNT	LOCATION: 18th St. approximately 50' North of Santa Maria Ave. SURFACE EL: 113.0 ft +/- (rel. MSL datum)	UNIT WET WEIGHT, pcf	UNIT DRY WEIGHT, pcf	WATER CONTENT, %	% PASSING #200 SIEVE	LIQUID LIMIT, %	PLASTICITY INDEX, %	UNDRAINED SHEAR STRENGTH, $S_u$ , ksf
112	2					ARTIFICIAL FILL (af) Aggregate base:							
110	4					DUNE SAND DEPOSITS (Gs) Sand with silt (SP-SM): loose, light brown, dry							
108	6		1	X	(17)	Grades to poorly-graded SAND (SP): medium dense, light brown, dry - medium dense, orange brown to brown, moist	113	108	5				
104	10		2	X	19								
100	14		3	X	(34)	- with pockets of light brown to light gray/buff sandy SILT (ML) from 14 ft to 24 ft, dry	113	108	4				
96	18		4	X	22								
92	24		5	X	(34)		109	103	6				
88	28		6	X	32								
84	34		7	X	(58)	- dense	113	108	5				
80	40		8	X	50								
76	44		9	X	(50/6)		108	102	6				
72	48		10	X	41				4	2			
68	50					2" steel casing installed; backfilled with native sand.							

COMPLETION DEPTH: 51.0 ft  
DEPTH TO WATER: Not Encountered  
BACKFILLED WITH: Native Materials  
DRILLING DATE: September 28, 2003

DRILLING METHOD: 8-in. dia. Hollow Stem Auger  
HAMMER TYPE: Automatic Trip  
DRILLED BY: S/G Drilling Company  
LOGGED BY: CLLevato  
CHECKED BY: JDBlanchar

The log and data presented are a simplification of actual conditions encountered at the time of drilling at the drilled location. Subsurface conditions may differ at other locations and with the passage of time.

**LOG OF NO. HP-2**  
Los Osos Wastewater Project  
Los Osos, California



ELEVATION, ft	DEPTH, ft	MATERIAL SYMBOL	SAMPLE NO.	SAMPLERS	SAMPLER BLOW COUNT	LOCATION: 16 feet north of Prototype Percolation Line SURFACE EL: 197.0 R +/- (rel. MSL datum)	PIEZOMETER	UNIT WET WEIGHT, pct	UNIT DRY WEIGHT, pct	WATER CONTENT, %	% PASSING #200 SIEVE	LIQUID LIMIT, %	PLASTICITY INDEX, %	UNDRAINED SHEAR STRENGTH, $S_u$ , ksf		
198	2	[Material Symbol: Sand with silt]	1			<b>DUNE SAND DEPOSITS (Qds)</b> Sand with silt (SP-SM): loose, dark brown, moist, with roots down to 3.5 feet - moderate brown below 3 feet - dark brown below 4 feet - medium dense below 5.5 feet - brown below 6.5 feet	[Piezometer Symbol]									
194	4															
192	6															
190	8															
188	10															
186	12							Sand (SP) to SAND with silt (SP-SM): medium dense to dense, light brown, dry to moist, with nodules of weakly cemented SAND with silt (SP-SM) to silty SAND (SM) - drive sample was not recovered; grab sample obtained								
184	14							Installed 1-inch PVC pipe monitoring well with 12" perforated section.								
182	16															
180	18															
178	20															
176	22															
174	24															
172	26															
170	28															
168	30															
166	32															
164	34															
162	36															
160	38															
158	40															
156	42															
154	44															
152	46															
150	48															
148	50															
148																

COMPLETION DEPTH: 10.0 ft  
 DEPTH TO WATER: Not Encountered  
 BACKFILLED WITH: Monitoring Well  
 DRILLING DATE: March 26, 2003

DRILLING METHOD: 4-in. dia. Hand Auger  
 HAMMER TYPE: Hard  
 DRILLED BY: Fugro  
 LOGGED BY: Clovato  
 CHECKED BY: JDBianchard

The log and data presented are a simplification of actual conditions encountered at the time of drilling at the drilled location. Subsurface conditions may differ at other locations and with the passage of time.

**LOG OF NO. MW-3**  
 Los Osos Wastewater Project  
 Los Osos, California



ELEVATION, ft	DEPTH, ft	MATERIAL SYMBOL	SAMPLE NO.	SAMPLERS	SAMPLER BLOW COUNT	LOCATION: Terminus of Alexander into Highland SURFACE EL: 182.0 ft +/- (rel. MSL datum)	PIEZOMETER	UNIT WET WEIGHT, pcf	UNIT DRY WEIGHT, pcf	WATER CONTENT, %	% PASSING #200 SIEVE	LIQUID LIMIT, %	PLASTICITY INDEX, %	UNDRAINED SHEAR STRENGTH, $S_u$ , ksf
						MATERIAL DESCRIPTION								
-186	2	[Symbol]				ARTIFICIAL FILL (af) 4" of SAND with silt and gravel (SP-SM); brown, dry	[Symbol]							
-178	4	[Symbol]				DUNE SAND (Qds) Silty SAND (SW); medium dense, dark brown to black, moist	[Symbol]							
-176	6	[Symbol]				loose below 2 feet Sand with silt (SP-SM); loose, moderate brown, moist	[Symbol]							
-174	8	[Symbol]				SAND (SP); medium dense, light yellowish brown, moist	[Symbol]							
-172	10	[Symbol]				grading to silty SAND with clay (SW); medium dense, to dense, light brown with reddish brown mottles, moist	[Symbol]							
-170	12					Installed 1-inch PVC monitoring well with 18-inch perforated section at bottom.								
-168	14													
-166	16													
-164	18													
-162	20													
-160	22													
-158	24													
-156	26													
-154	28													
-152	30													
-150	32													
-148	34													
-146	36													
-144	38													
-142	40													
-140	42													
-138	44													
-136	46													
-134	48													
-132	50													

COMPLETION DEPTH: 10.0 ft  
 DEPTH TO WATER: Not Encountered  
 BACKFILLED WITH: Monitoring Well  
 DRILLING DATE: March 26, 2003

DRILLING METHOD: 4-in. dia. Hand Auger  
 HAMMER TYPE: Hand  
 DRILLED BY: Fugro  
 LOGGED BY: C Lovato  
 CHECKED BY: JDBlanchar

The log and data presented are a simplification of actual conditions encountered at the time of drilling at the drilled location. Subsurface conditions may differ at other locations and with the passage of time.

**LOG OF NO. MW-4**  
 Los Osos Wastewater Project  
 Los Osos, California

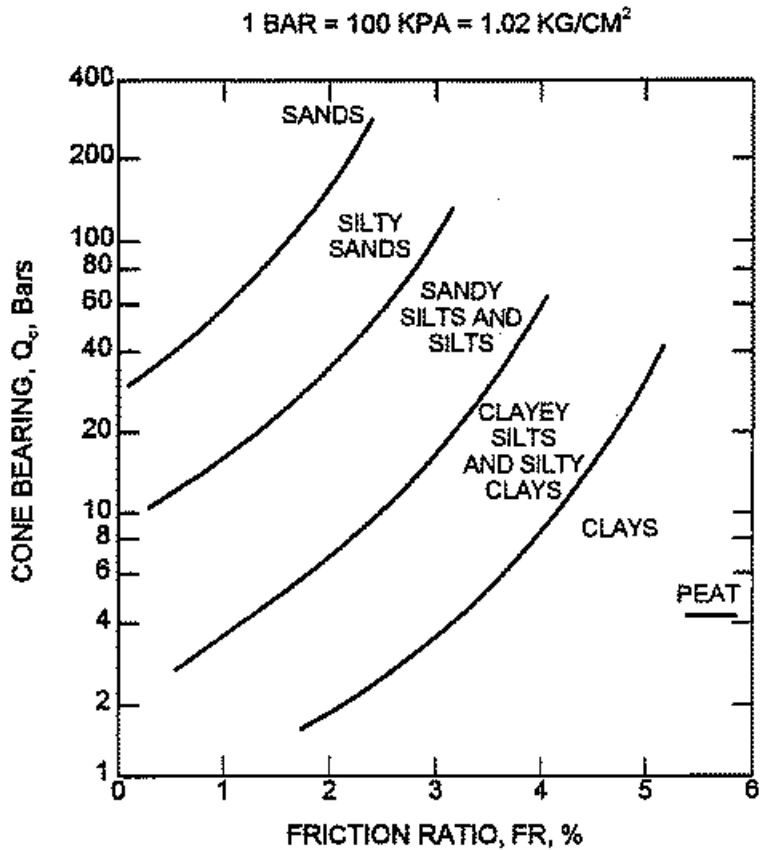

CAMPANELLA AND ROBERTSON CLASSIFICATION CHART

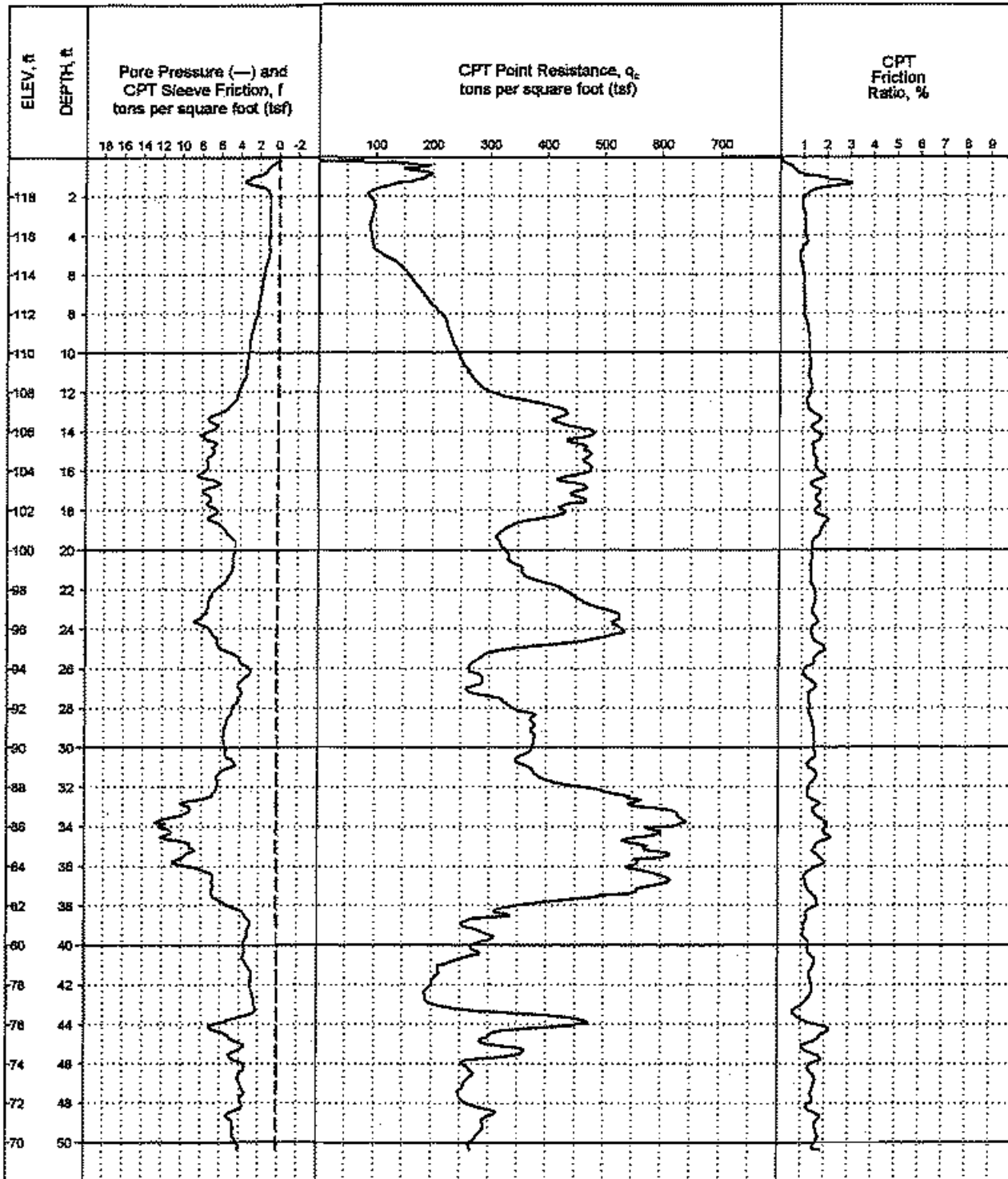

LOCATION: Santa Maria Ave., 125' east of 13th St.  
 SURFACE EL: 120 ft +/- (rel. MSL datum)  
 COMPLETION DEPTH: 50.3 ft  
 EXPLORATION DATE: August 5, 2003  
 DEPTH TO WATER: Not Encountered

EXPLORATION METHOD: Cone Penetrometer  
 PERFORMED BY: Fugro Geosciences  
 REVIEWED BY: JDBlanchar

**LOG OF CPT NO: CPT-401**  
**Los Osos Wastewater Project**  
**Los Osos, California**

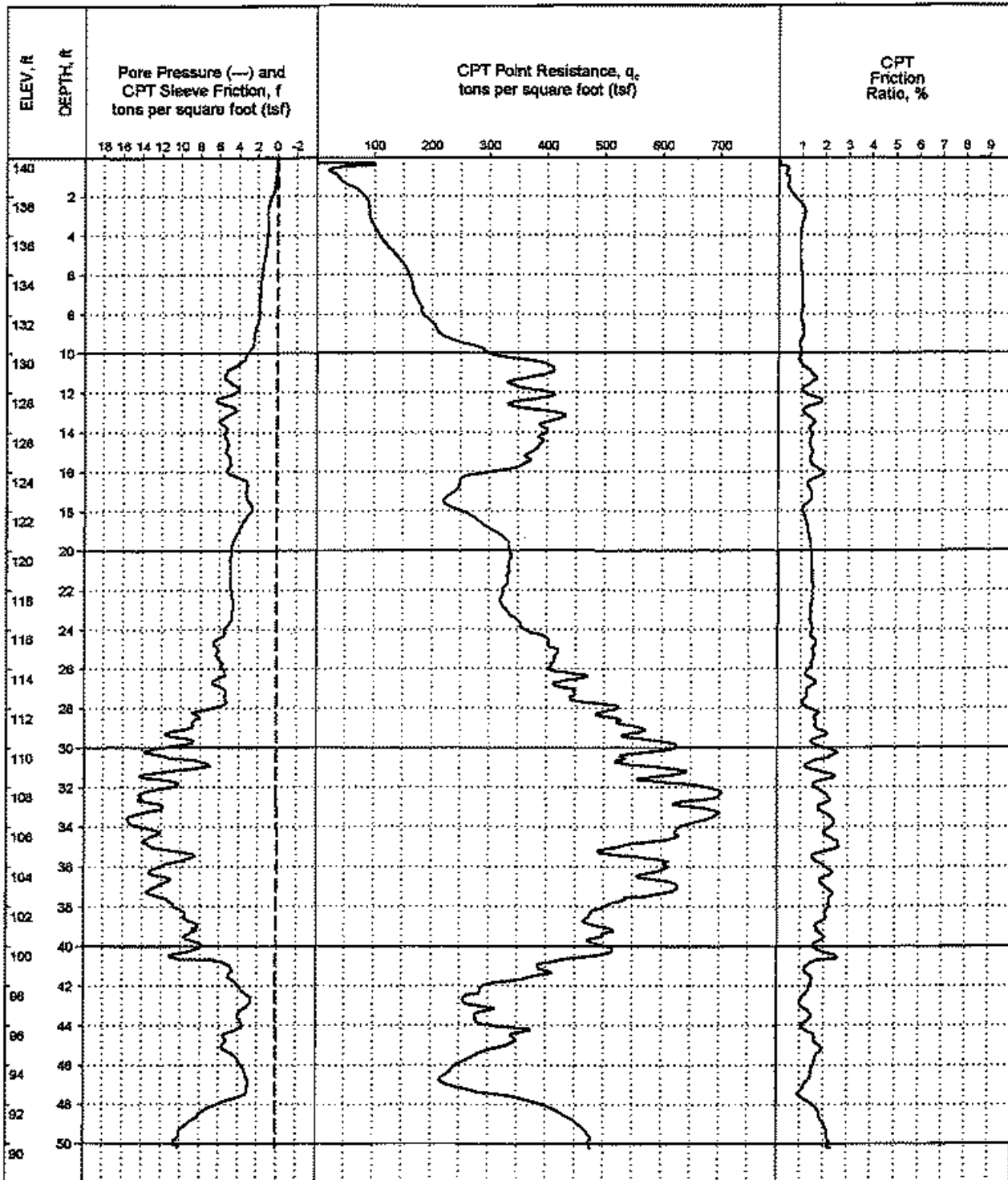

LOCATION: Santa Maria Ave., 120' west of 16th St.  
 SURFACE EL: 141 ft +/- (rel. MSL datum)  
 COMPLETION DEPTH: 50.2 ft  
 EXPLORATION DATE: August 6, 2003  
 DEPTH TO WATER: Not Encountered

EXPLORATION METHOD: Cone Penetrometer  
 PERFORMED BY: Fugro Geosciences  
 REVIEWED BY: JDBlanchar

**LOG OF CPT NO: CPT-402**  
 Los Osos Wastewater Project  
 Los Osos, California



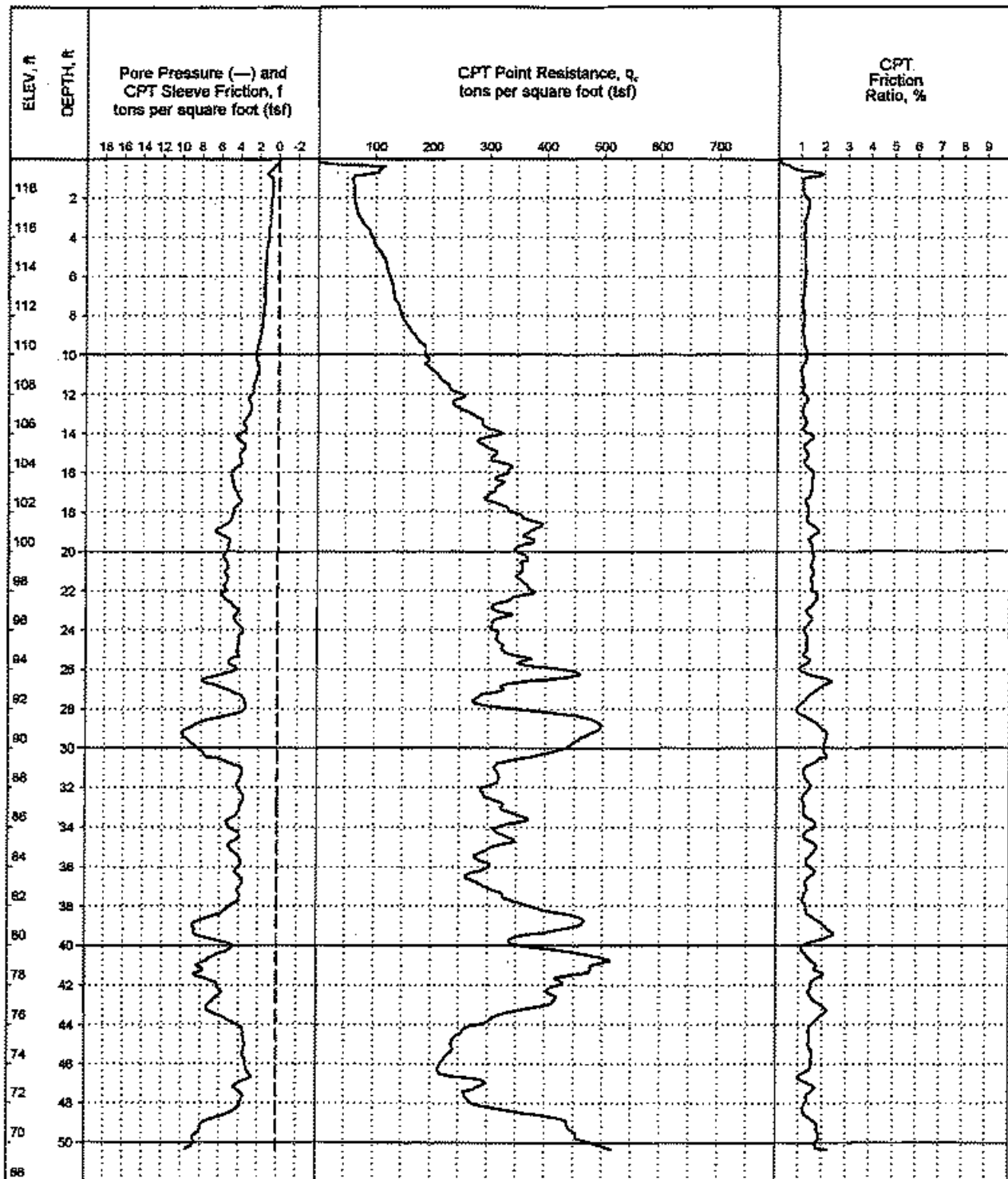

LOCATION: East end of Santa Maria Ave., 345' east of 17th St.  
 SURFACE EL: 120 ft +/- (rel. MSL datum)  
 COMPLETION DEPTH: 50.3 ft  
 EXPLORATION DATE: August 6, 2003  
 DEPTH TO WATER: Not Encountered

EXPLORATION METHOD: Cone Penetrometer  
 PERFORMED BY: Fugro Geosciences  
 REVIEWED BY: JDBanchard

**LOG OF CPT NO: CPT-403**  
 Los Osos Wastewater Project  
 Los Osos, California

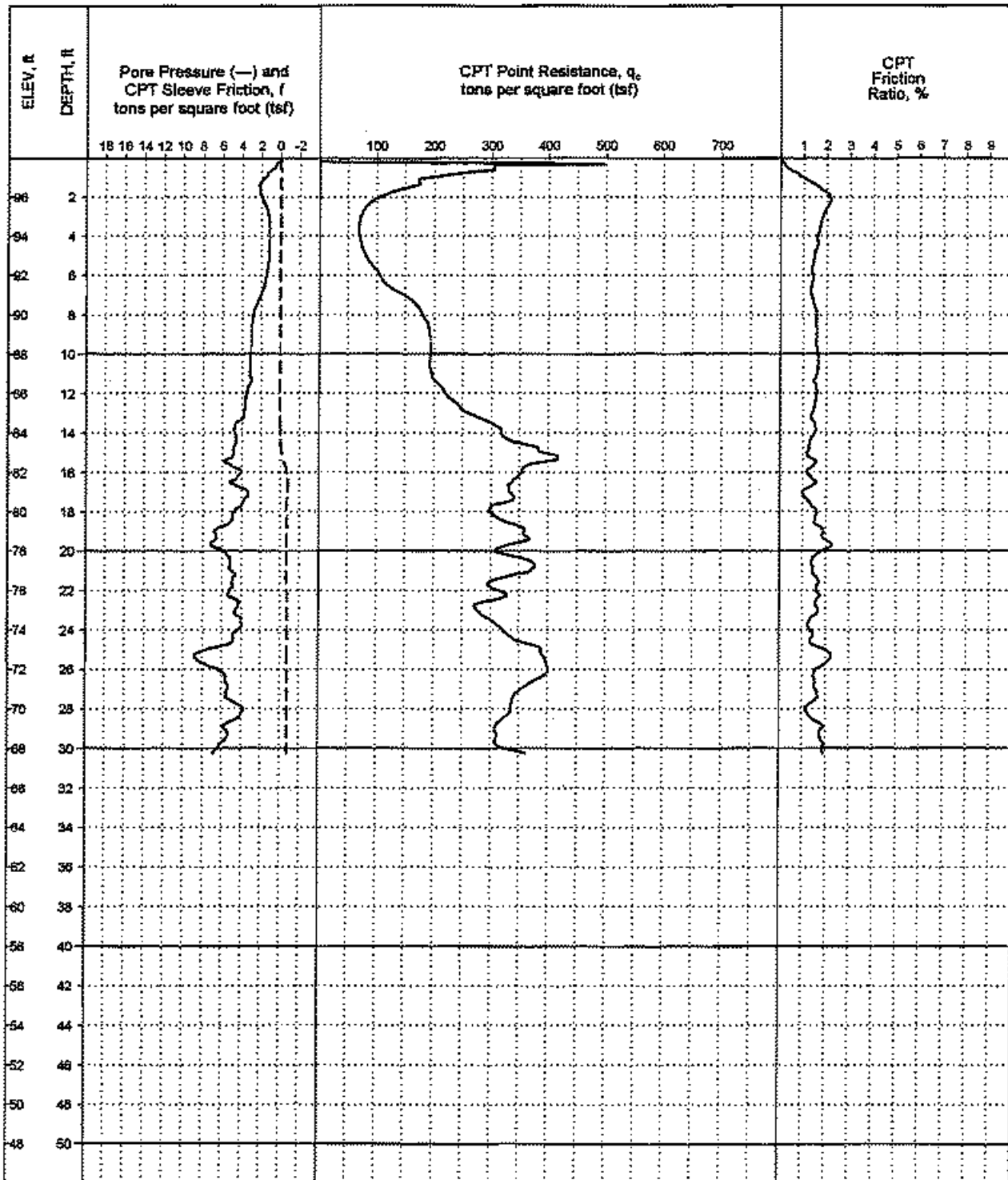

LOCATION: 13th St., 260' north of San Luis Ave.  
 SURFACE EL: 98 ft +/- (rel. MSL datum)  
 COMPLETION DEPTH: 30.3 ft  
 EXPLORATION DATE: August 7, 2003  
 DEPTH TO WATER: 16.7 ft

EXPLORATION METHOD: Cone Penetrometer  
 PERFORMED BY: Fugro Geosciences  
 REVIEWED BY: JDBlanchar

**LOG OF CPT NO: CPT-404**  
 Los Osos Wastewater Project  
 Los Osos, California

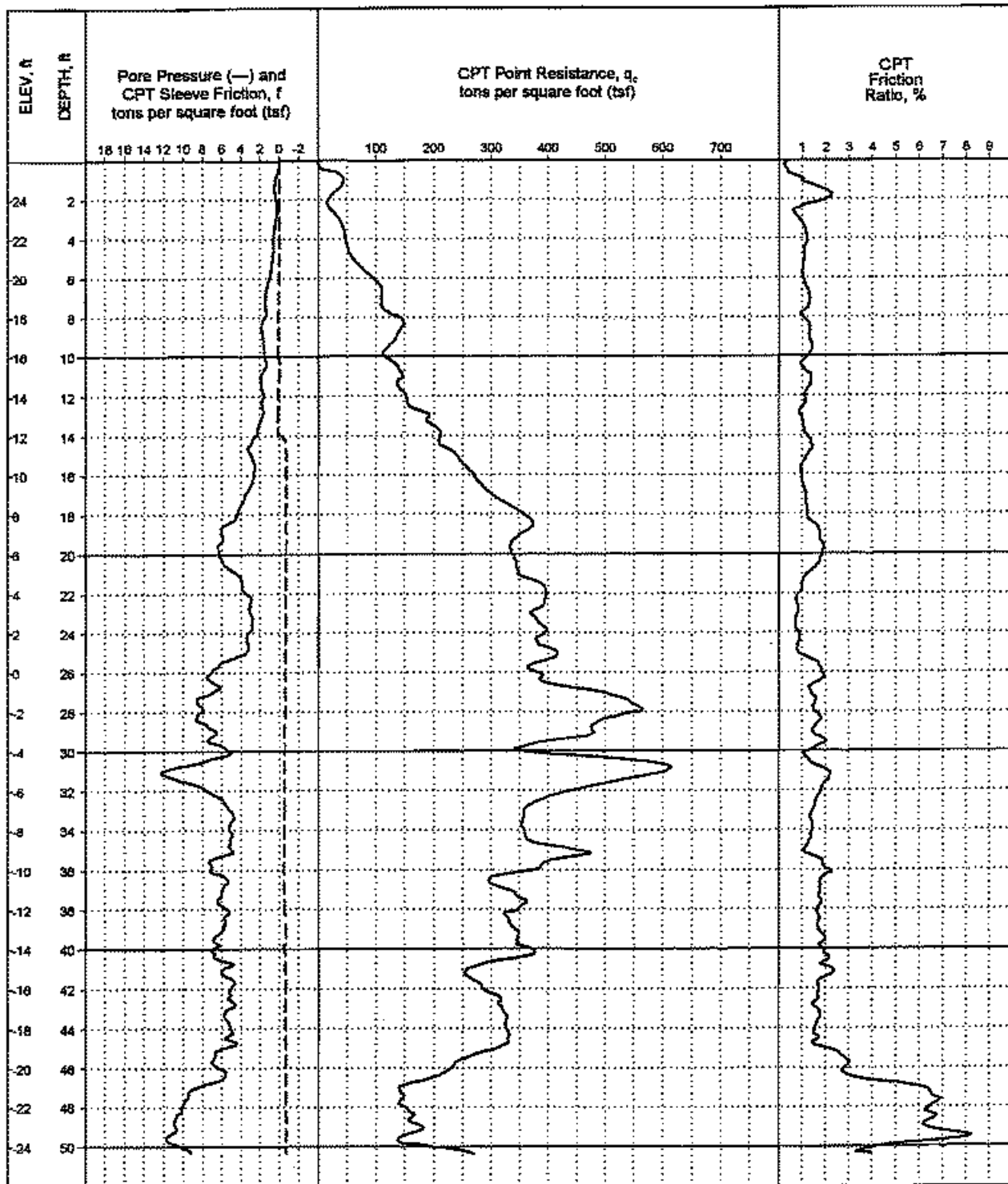

LOCATION: 158' south of El Morro Ave., 90' east of 8th St.  
 SURFACE EL: 26 ft +/- (rel. MSL datum)  
 COMPLETION DEPTH: 50.3 ft  
 EXPLORATION DATE: August 6, 2003  
 DEPTH TO WATER: 6 ft

EXPLORATION METHOD: Cone Penetrometer  
 PERFORMED BY: Fugro Geosciences  
 REVIEWED BY: JDBlanchar

**LOG OF CPT NO: CPT-405**  
 Los Osos Wastewater Project  
 Los Osos, California

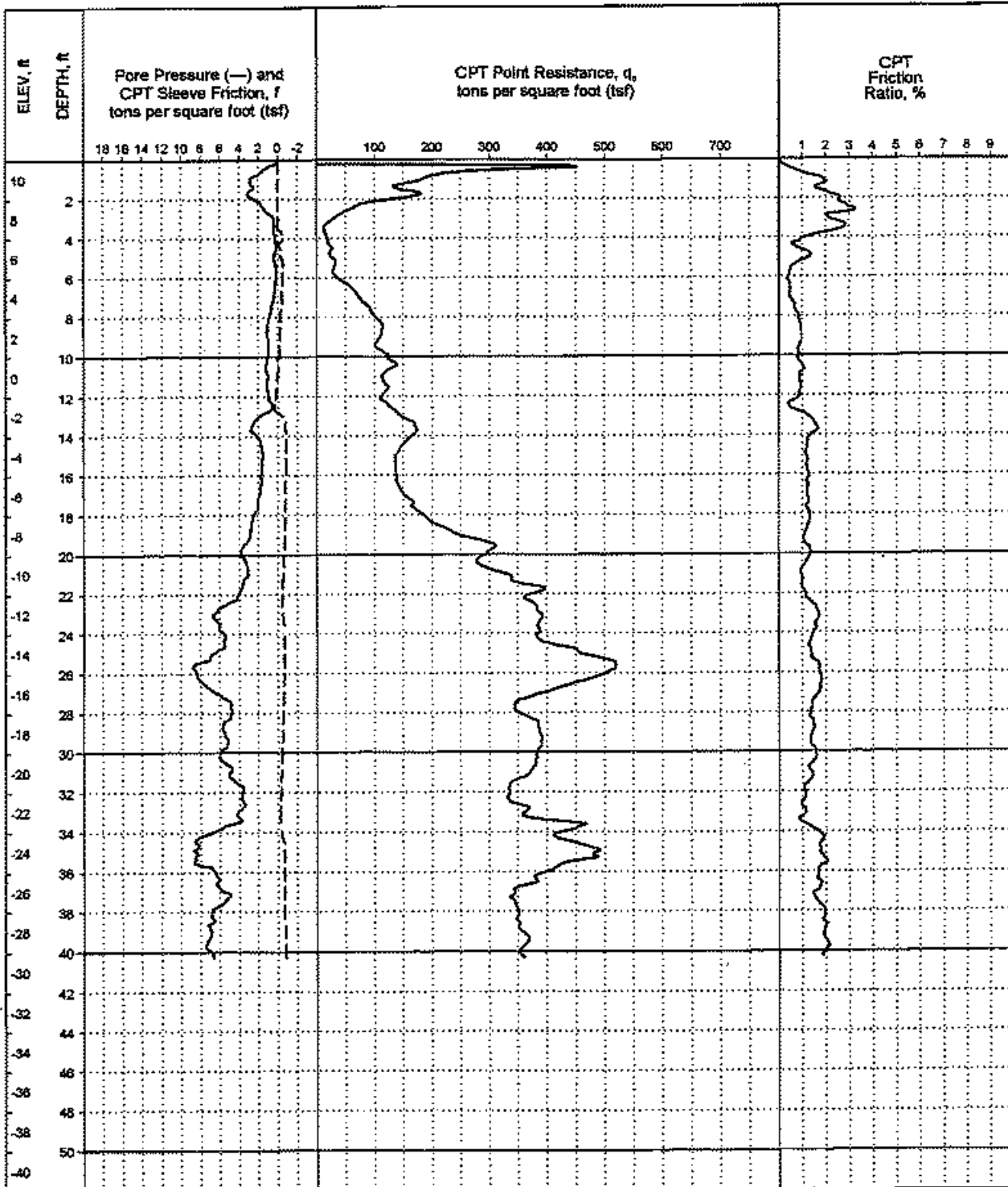

LOCATION: Intersection of 2nd St., and El Morro Ave.  
 SURFACE EL: 11 ft +/- (rel. MSL datum)  
 COMPLETION DEPTH: 40.3 ft  
 EXPLORATION DATE: August 6, 2003  
 DEPTH TO WATER: 2.6 ft

EXPLORATION METHOD: Cone Penetrometer  
 PERFORMED BY: Fugro Geosciences  
 REVIEWED BY: JDBianchard

**LOG OF CPT NO: CPT-406**  
 Los Osos Wastewater Project  
 Los Osos, California

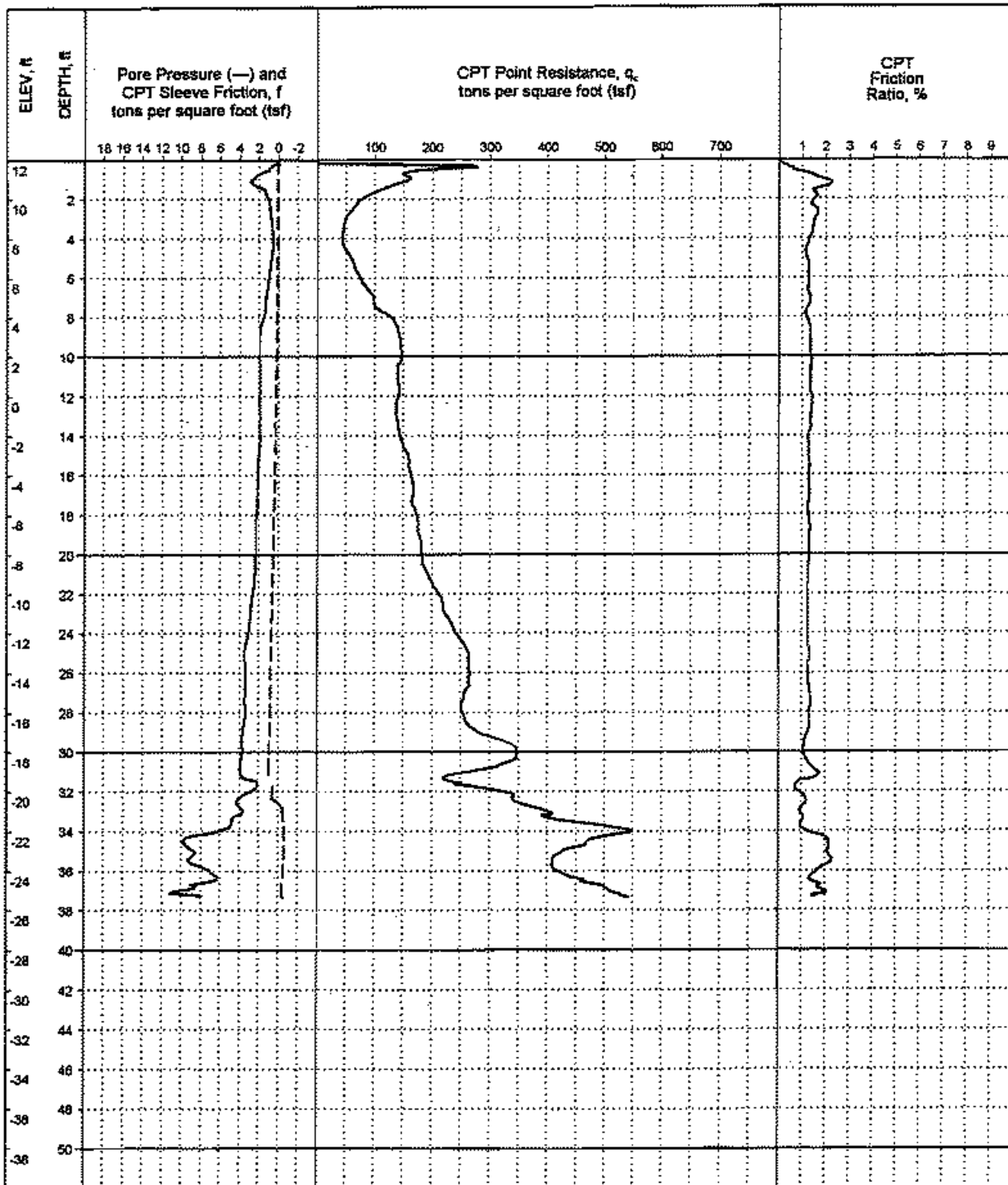

LOCATION: 50' west of 3rd St., 310' south of El Morro Ave.  
 SURFACE EL: 13 ft +/- (rel. MSL datum)  
 COMPLETION DEPTH: 37.3 ft  
 EXPLORATION DATE: August 6, 2003  
 DEPTH TO WATER: 3.5 ft

EXPLORATION METHOD: Cone Penetrometer  
 PERFORMED BY: Fugro Geosciences  
 REVIEWED BY: JDBlancharc

**LOG OF CPT NO: CPT-407**  
 Los Osos Wastewater Project  
 Los Osos, California

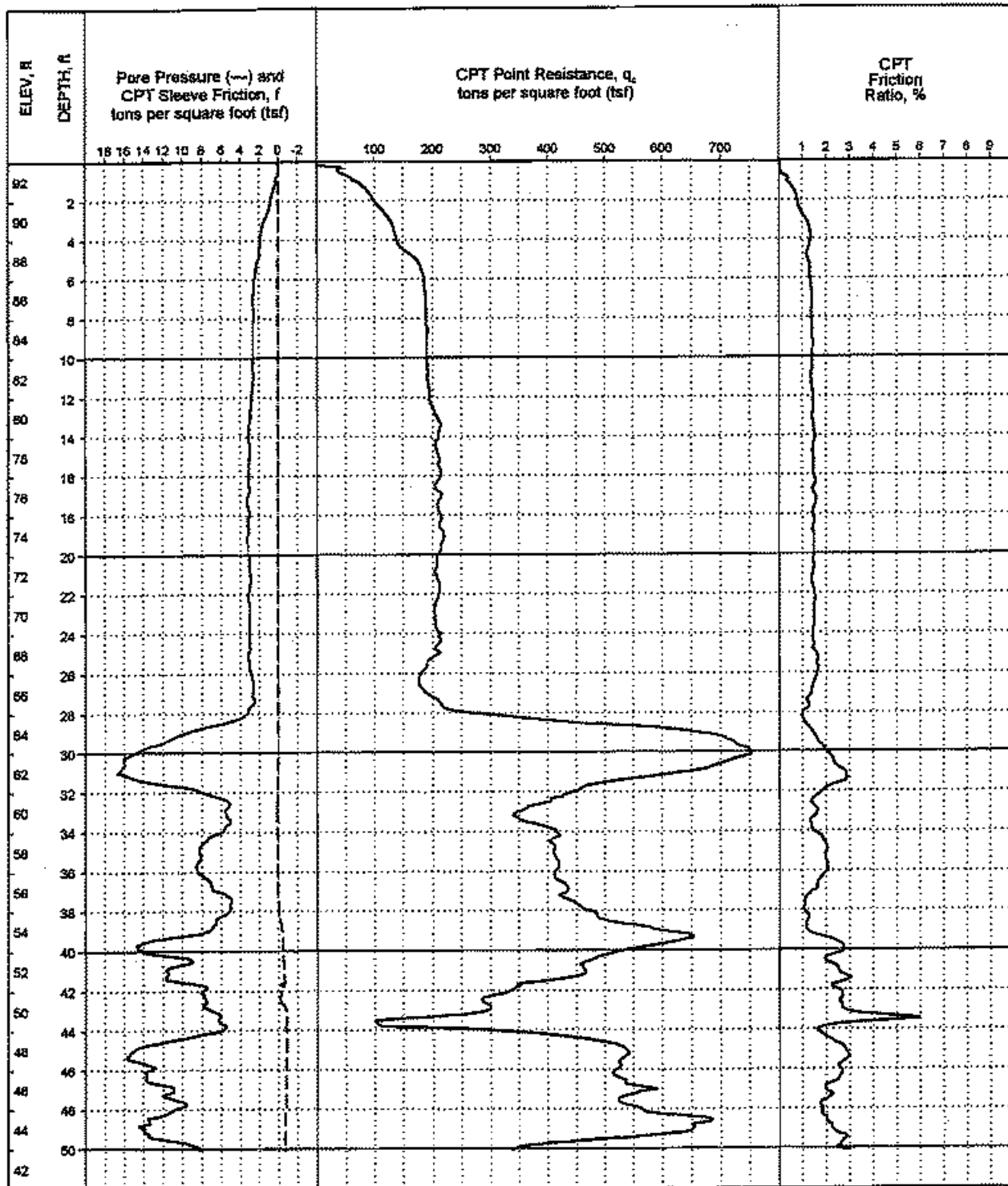

LOCATION: Pismo Ave., 125' west of 10th St.  
 SURFACE EL: 93 ft +/- (rel. MSL datum)  
 COMPLETION DEPTH: 50.1 ft  
 EXPLORATION DATE: August 7, 2003  
 DEPTH TO WATER: 40.5 ft

EXPLORATION METHOD: Cone Penetrometer  
 PERFORMED BY: Fugro Geosciences  
 REVIEWED BY: JDBlanchar

**LOG OF CPT NO: CPT-408**  
 Los Osos Wastewater Project  
 Los Osos, California

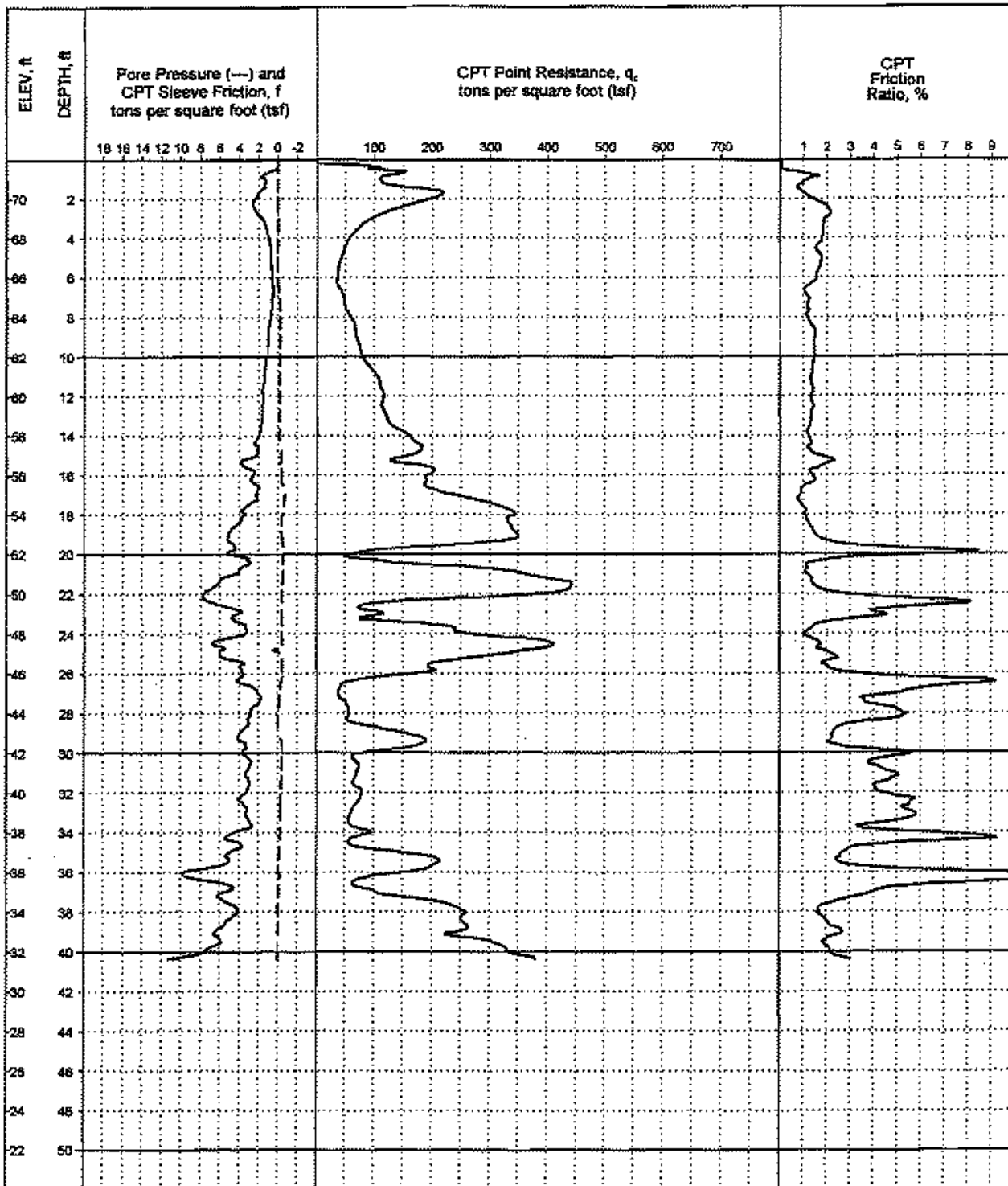

LOCATION: 18th St., 50' south of Paso Robles Ave.  
 SURFACE EL: 72 ft +/- (rel. MSL datum)  
 COMPLETION DEPTH: 40.4 ft  
 EXPLORATION DATE: August 6, 2003  
 DEPTH TO WATER: 7.9 ft

EXPLORATION METHOD: Cone Penetrometer  
 PERFORMED BY: Fugro Geosciences  
 REVIEWED BY: JDBianchard

**LOG OF CPT NO: CPT-409**  
 Los Osos Wastewater Project  
 Los Osos, California

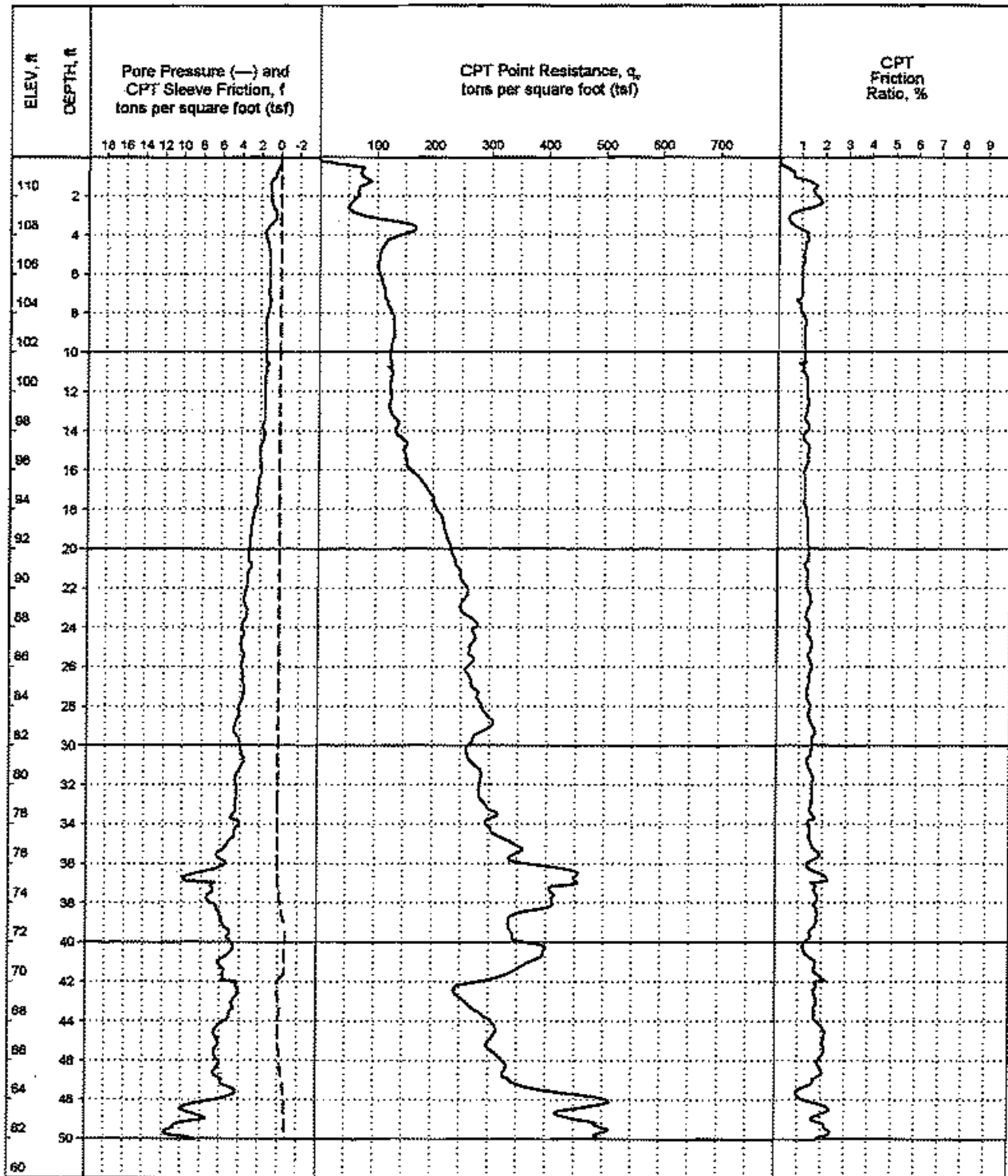

LOCATION: Pismo Ave., 155' west of 18th St.  
 SURFACE EL: 112 ft +/- (rel. MSL datum)  
 COMPLETION DEPTH: 50.0 ft  
 EXPLORATION DATE: August 6, 2003  
 DEPTH TO WATER: 42.5 ft

EXPLORATION METHOD: Cone Penetrometer  
 PERFORMED BY: Fugro Geosciences  
 REVIEWED BY: JDBlanchar

**LOG OF CPT NO: CPT-410**  
 Los Osos Wastewater Project  
 Los Osos, California



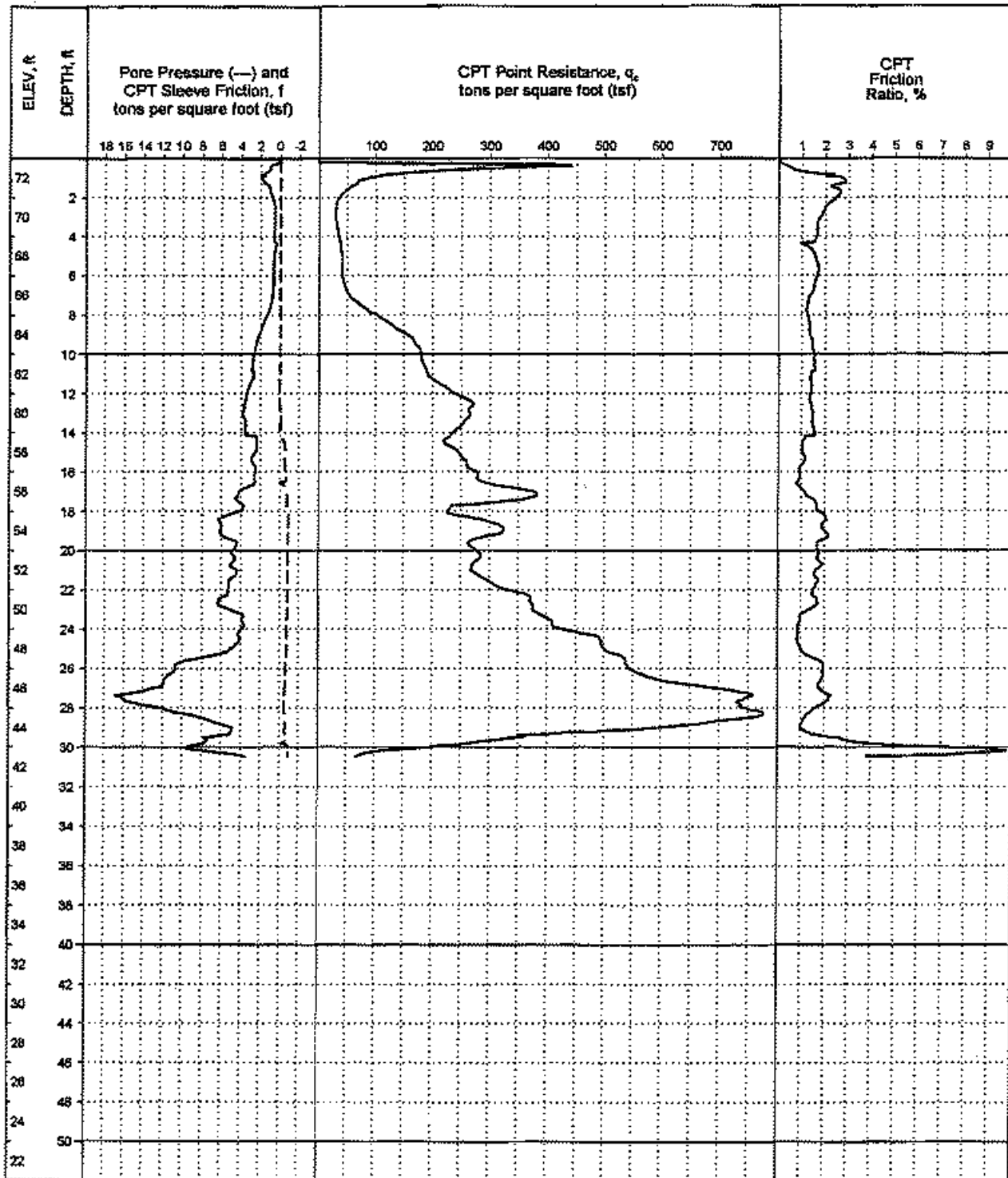

LOCATION: 9th St., 130' north of Ramona Ave.  
 SURFACE EL: 73 R +/- (rel. MSL datum)  
 COMPLETION DEPTH: 30.5 R  
 EXPLORATION DATE: August 7, 2003  
 DEPTH TO WATER: 14.5 R

EXPLORATION METHOD: Cone Penetrometer  
 PERFORMED BY: Fugro Geosciences  
 REVIEWED BY: JDBlanchar

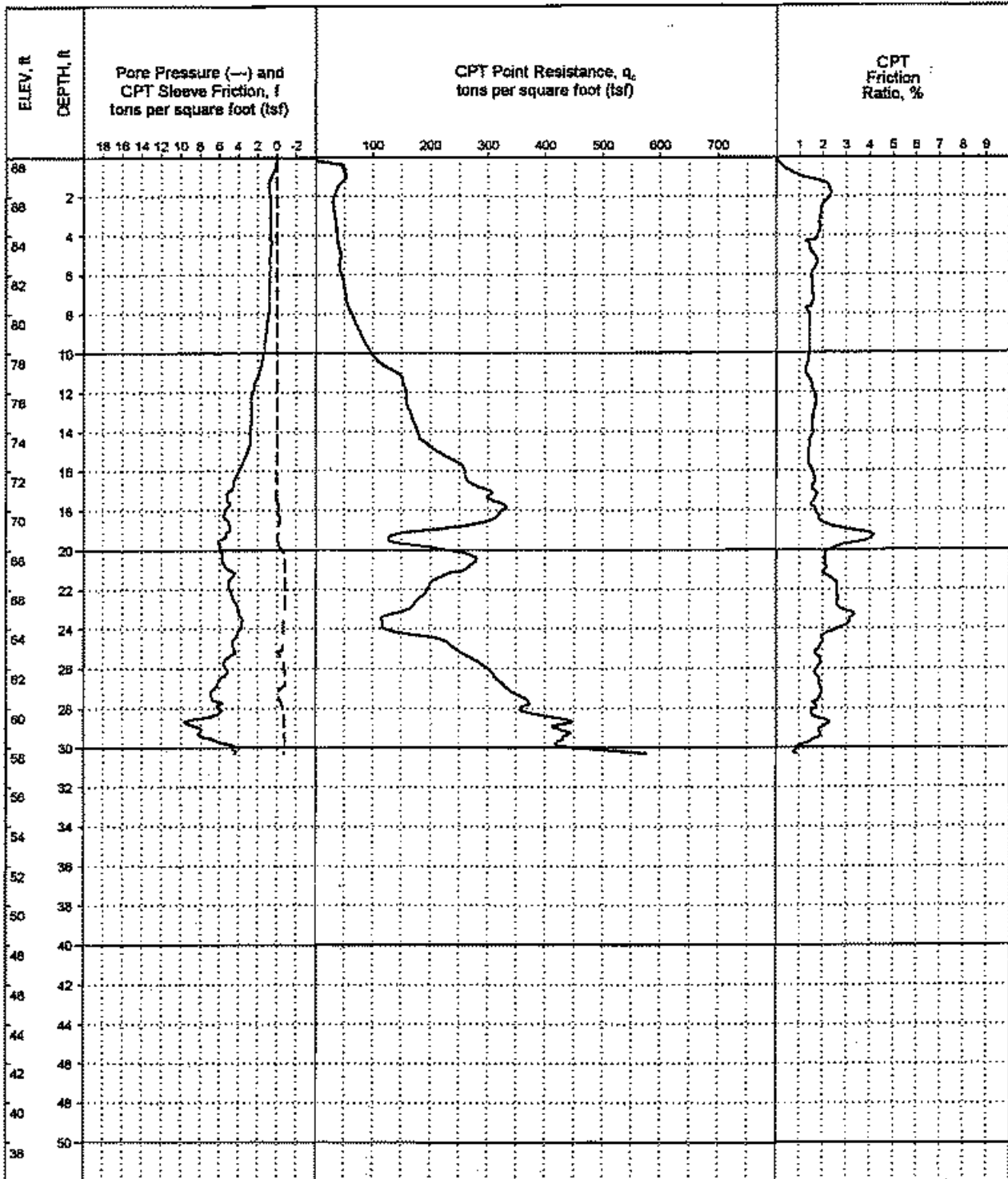

LOCATION: San Luis Ave., 45' east of 9th St.  
 SURFACE EL: 89 ft +/- (rel. MSL datum)  
 COMPLETION DEPTH: 30.3 ft  
 EXPLORATION DATE: August 7, 2003  
 DEPTH TO WATER: 20.5 ft

EXPLORATION METHOD: Cone Penetrometer  
 PERFORMED BY: Fugro Geosciences  
 REVIEWED BY: JDBianchard

**LOG OF CPT NO: CPT-412**  
 Los Osos Wastewater Project  
 Los Osos, California

PLATE A-34

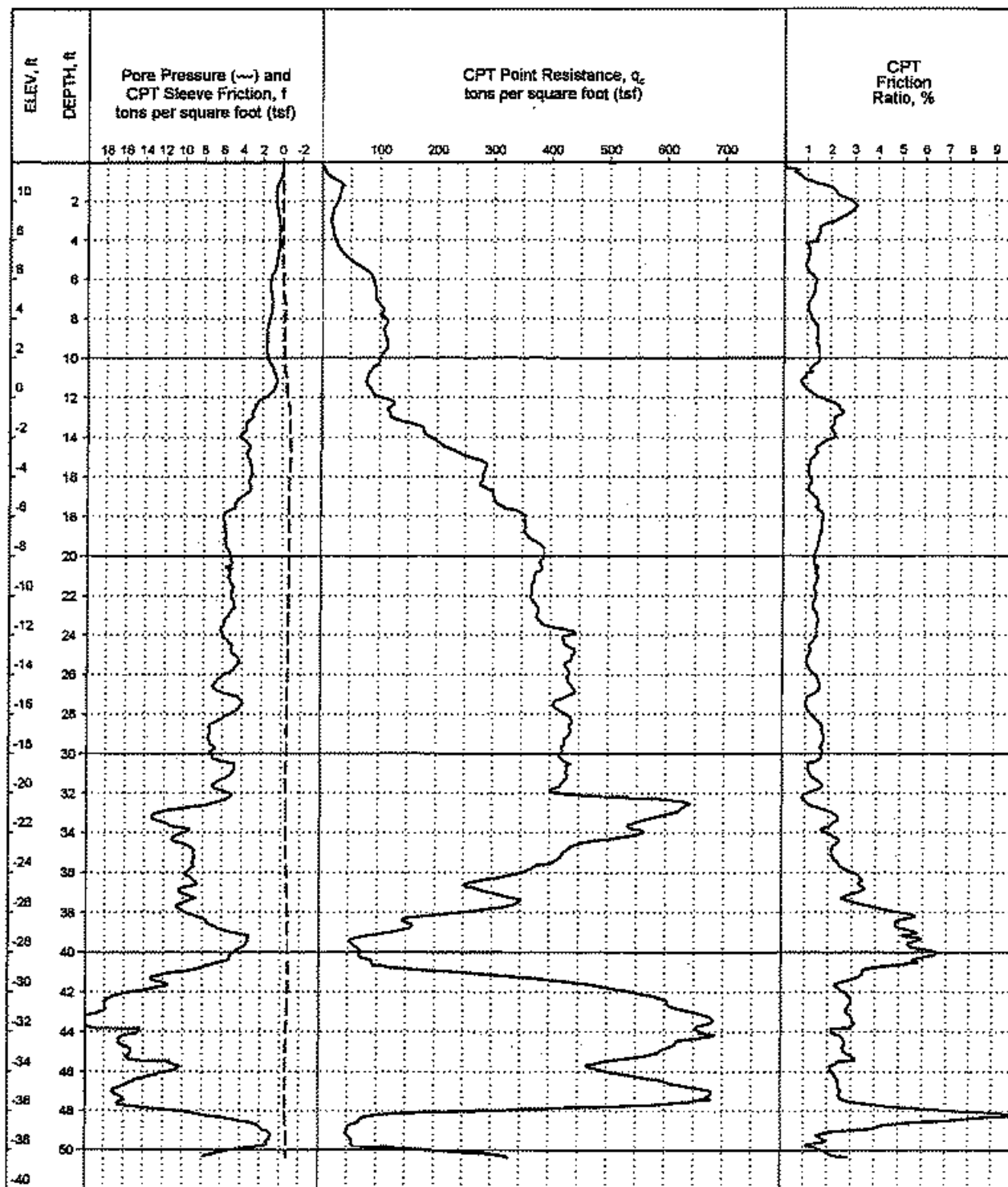

LOCATION: Donna Ave., 50' south of Lupine St.  
 SURFACE EL: 12 ft +/- (ref. MSL datum)  
 COMPLETION DEPTH: 50.3 ft  
 EXPLORATION DATE: August 7, 2003  
 DEPTH TO WATER: 5 ft

EXPLORATION METHOD: Cone Penetrometer  
 PERFORMED BY: Fugro Geosciences  
 REVIEWED BY: JDB/anchard

**LOG OF CPT NO: CPT-413**  
 Los Osos Wastewater Project  
 Los Osos, California



## APPENDIX B



EXPLORATION	DEPTH #	SAMPLE NUMBER	MATERIAL DESCRIPTION	UWWW pcf	UDW pcf	MC% pcf	FINES %	ATTERBERG LIMITS		COMPACTION TEST		DIRECT SHEAR	COMPRESSIVE STRENGTH	CORROSIVITY TESTS				PERMEABILITY (ft/m)	SAND EQUIVALENT (SE)	COMMENTS
								LL	PI	MAX DD pcf	OPT MC %			C	PHI deg	Qu ksf	S <sub>cell</sub> ksf			
DH-401	1.5	1	Silty SAND (SM)	103	101	3														
DH-401	4.0	2	Poorly graded SAND (SP)			3	1													
DH-401	9.0	3	Poorly graded SAND (SP)	131	127	4														
DH-401	19.0	5	SAND with clay (SP-SC)	132	198	22														3.27E-2
DH-401	24.0	6	SAND with clay (SP-SC)	128	186	21														
DH-401	34.0	8	Silty SAND (SM)			25														
DH-402	9.0	2	Poorly graded SAND (SP)	108	106	2														
DH-402	14.0	3	Poorly graded SAND (SP)			7	2													
DH-402	19.0	4	Poorly graded SAND (SP)	131	159	20														2.06E-2
DH-403	1.0	1	SAND with silt (SP-SM)	108	106	2														
DH-403	9.0	3	Poorly graded SAND (SP)	107	104	3														
DH-403	11.0	A	Poorly graded SAND (SP)																	
DH-403	19.0	5	Poorly graded SAND (SP)	108	103	5														34
DH-404	1.5	1	Poorly graded SAND with silt (SP-SM)	104	103	2														
DH-404	3.0	A	Poorly graded SAND with silt (SP-SM)																	
DH-404	5.0	3	Poorly graded SAND with silt (SP-SM)	111	106	5														2.44E-2
DH-404	9.0	4	Poorly graded SAND with silt (SP-SM)				9													
DH-404	14.0	5	Poorly graded SAND with silt (SP-SM)	130	107	21														9.06E-3
DH-405	2.0	1	Poorly graded SAND (SP)	106	102	4														
DH-405	2.0	A	Poorly graded SAND (SP)																	
DH-405	7.0	3	Poorly graded SAND (SP)	109	104	5														
DH-405	14.0	5	Poorly graded SAND (SP)	116	108	8														
DH-406	2.0	1	Silty SAND (SM)	108	105	4														
DH-406	9.0	3	SAND with silt (SP-SM)	131	119	9														
DH-406	19.0	5	Clayey SAND (SC)	118	107	11	25													
DH-406	24.0	6	Lean CLAY (CL)			20		34	27											
DH-406	29.0	7	SAND with clay and gravel (SP-SC)	140	122	15	11													
DH-406	34.0	8	Lean CLAY (CL)			18		39	19											
DH-407	1.0	1	Silty SAND (SM)	107	105	2														
DH-407	7.0	A	Poorly graded SAND (SP)																	66
DH-407	7.0	A	Poorly graded SAND (SP)																	45

**SUMMARY OF LABORATORY TEST RESULTS**  
Los Osos Wastewater Project  
Los Osos, California

**Classification Tests**  
UWW = Unit Wet Weight  
UDW = Unit Dry Weight  
MC = Moisture Content  
Fines = % Passing #200 Sieve  
LL = Liquid Limit  
PI = Plasticity Index

**Direct Shear Test**  
C = Assigned Cohesion, ksf  
PHI = Assigned Friction Angle, degrees

**Compaction Test**  
MAX DD = Maximum Dry Density  
OPT MC = Optimum Moisture Content

**Compressive Strength Tests**  
Qu = Unconfined Compression  
Su = Untrained Shear Strength  
u = Unconsolidated Undrained  
p = Pocket Penetrometer  
Ts = Torvane  
m = Moisture Value

**Corrosivity Tests**  
R = Resistivity, ohm-cm, satur.  
pH = pH  
Cl = Chloride, ppm  
SO<sub>4</sub> = Sulfate, ppm



EXPLORATION	DEPTH #	SAMPLE NUMBER	MATERIAL DESCRIPTION	UWWW pcf	UDW pcf	MC% %	FINES %	ATTERBERG LIMITS		COMPACTION TEST			DIRECT SHEAR		COMPRESSIVE STRENGTH		CORROSION TESTS				PERMEABILITY (ft/min)	SAND EQUIVALENT (SE)	COMMENTS
								LL	PI	MAX DD pcf	OPT MC %	C ksf	PHI deg	Cu, ksf	S <sub>u</sub> (Cell) ksf	R	pH	Cl	SO <sub>4</sub>				
DH-407	9.0	3	Poorly-graded SAND (SP)	107	104	2																	
DH-407	19.0	5	Poorly-graded SAND (SP)	128	113	14																	
DH-408	1.0	1	Poorly-graded SAND (SP)	108	104	3																	
DH-408	9.0	3	Poorly-graded SAND (SP)	108	103	4																	
DH-408	9.0	A	Poorly-graded SAND (SP)	107	101	6																53	
DH-408	19.0	5	Poorly-graded SAND (SP)																				
DH-409	2.0	1	Poorly-graded SAND (SP)	108	103	5	2																
DH-409	4.0	2	Poorly-graded SAND (SP)																				
DH-409	9.0	A	Poorly-graded SAND (SP)																			36	
DH-409	14.0	4	Poorly-graded SAND (SP)	108	103	4																	
DH-410	4.0	2	Silty SAND (SM)	101	98	3																61	
DH-410	9.0	A	SAND with silt (SP-SM)																			47	
DH-410	14.0	4	Poorly-graded SAND (SP)	107	104	3																	
DH-411	1.5	1	Poorly-graded SAND (SP)	99	97	2	3																
DH-411	3.5	2	Poorly-graded SAND (SP)																				
DH-411	4.0	A	Poorly-graded SAND (SP)																				
DH-411	8.5	3	Poorly-graded SAND (SP)	108	103	3				112	12											55	
DH-412	4.0	2	Silty SAND (SM)	101	97	4																	
DH-412	9.0	3	Silty SAND (SM)																				44
DH-412	14.0	4	Poorly-graded SAND (SP)	118	105	13	15	21															
HA-401	2.0	A	SAND with silt (SP-SM)	97	9	9																	
HA-401	3.0	2	SAND with silt (SP-SM)	105	102	3				108	9	0.25	29										
HA-401	8.0	3	Fat CLAY (CH)																				
HA-403	0.5	A	SAND with silt (SP-SM)				32	35															
HA-403	1.5	1	SAND with silt (SP-SM)	199	103	6	6			109	6	0.20	26										
HP-1	4.5	1	Poorly-graded SAND (SP)	110	106	4																	
HP-1	14.5	3	Poorly-graded SAND (SP)	113	108	4																	2.66E-2
HP-1	19.5	4	Poorly-graded SAND (SP)				4	3															
HP-1	24.5	5	Poorly-graded SAND (SP)	114	108	5																	
HP-1	34.5	7	Poorly-graded SAND (SP)	108	102	6																	3.72E-2

**Classification Tests**  
UWWW = Unit Wet Weight  
UDW = Unit Dry Weight  
MC = Moisture Content  
Fines = % Passing #200 Sieve  
LL = Liquid Limit  
PI = Plasticity Index

**Direct Shear Tests**  
C = Assigned Cohesion, ksi  
PHI = Assigned Friction Angle, degrees  
Compassion Test  
MAX DD = Maximum Dry Density  
OPT MC = Optimum Moisture Content

**Compressive Strength Tests**  
Cu = Unconfined Compression  
Su = Undrained Shear Strength  
u = Unconsolidated Undrained  
p = Pocket Penetrometer  
t = Torque  
m = Miniature Vane

**Corrosivity Tests**  
R = Resistivity, ohm-cm, satur.  
pH = pH  
Cl = Chloride, ppm  
SO<sub>4</sub> = Sulfate, ppm

**SUMMARY OF LABORATORY TEST RESULTS**  
Los Osos Wastewater Project  
Los Osos, California



EXPLORATION	DEPTH, #	SAMPLE NUMBER	MATERIAL DESCRIPTION	UWW	UDW	MC%	FINES %	ATTERBERG LIMITS		COMPACTION TEST		DIRECT SHEAR		COMPRESSIVE STRENGTH TESTS		CORROSION TESTS					PERMEABILITY (ft/min)	SAND EQUIVALENT (SE)	COMMENTS	
								LL	PI	MAX DD	OPT MC	C	PH	QU	S <sub>u</sub> (Cell Plus)	R	PH	Cl	S <sub>u</sub>					
HP-1	39.5	8	Poorly-graded SAND (SP)				5																	
HP-1	44.5	9	Poorly-graded SAND (SP)	106	103	3	3																3.86E-2	
HP-1	49.5	10	Poorly-graded SAND (SP)				5																	
HP-2	4.0	1	Poorly-graded SAND (SP)	113	108	5	5																	
HP-2	14.0	3	Poorly-graded SAND (SP)	113	108	4	4																	
HP-2	24.0	5	Poorly-graded SAND (SP)	109	103	6	6																	
HP-2	34.0	7	Poorly-graded SAND (SP)	113	108	5	5																	
HP-2	44.0	9	Poorly-graded SAND (SP)	108	102	6	6																	
HP-2	49.0	10	Poorly-graded SAND (SP)				4																	
L-1	4.5	1	Poorly-graded SAND (SP)	101	98	3	3																	
L-2	4.5	1	Poorly-graded SAND (SP)	102	100	3	3																	
L-3	4.5	1	Poorly-graded SAND (SP)	104	102	2	2																	
P-1	4.5	1	Poorly-graded SAND (SP)	108	103	5	5																	
P-2	4.8	1	Poorly-graded SAND (SP)				5																	
P-6	4.8	1	Poorly-graded SAND (SP)				4																	
P-7	4.5	1	Poorly-graded SAND (SP)	103	98	4	4																	
P-10	4.9	1	Poorly-graded SAND (SP)	111	105	6	6																	
P-12	4.5	1	Poorly-graded SAND (SP)	115	109	5	5																	
P-14	5.0	1	Poorly-graded SAND (SP)	104	99	5	5																	
P-16	5.0	1	Poorly-graded SAND (SP)	107	104	3	3																	
P-17	4.5	1	Poorly-graded SAND (SP)	110	104	6	6																	
P-23	4.5	1	Poorly-graded SAND (SP)	114	108	5	5																	
P-24	4.5	1	Poorly-graded SAND (SP)	110	105	5	5																	
P-26	4.5	1	Poorly-graded SAND (SP)	100	96	5	5																	
P-28	4.5	1	Poorly-graded SAND (SP)	95	92	4	2																	
P-3W1	4.5	1	Poorly-graded SAND (SP)	106	104	3	5																	
P-3W2	4.5	1	Poorly-graded SAND (SP)	97	90	8	5																	
P-3W3	4.5	1	Poorly-graded SAND (SP)	106	103	3	1																	
P-SP1	4.5	1	Poorly-graded SAND (SP)	116	108	7	1																	
P-SP2	4.5	1	Poorly-graded SAND (SP)	119	104	5	3																	

**Classification Tests**  
 UWW = Unit Wet Weight  
 UDW = Unit Dry Weight  
 MC = Moisture Content  
 Fines = % Passing #200 Sieve  
 LL = Liquid Limit  
 PI = Plasticity Index

**Direct Shear Test**  
 C = Assigned Cohesion, ksf  
 PH = Assigned Friction Angle, degrees

**Compaction Test**  
 MAX DD = Maximum Dry Density  
 OPT MC = Optimum Moisture Content

**Compressive Strength Tests**  
 QU = Unconfined Compression  
 S<sub>u</sub> = Untriaxial Shear Strength  
 u = Unconsolidated Undrained  
 p = Pocket Penetrometer  
 t = Torque  
 m = Miniature Vane

**Corrosivity Tests**  
 R = Resistivity, ohm-cm, satur.  
 pH = pH  
 Cl = Chloride, ppm  
 SO<sub>4</sub> = Sulfate, ppm

**SUMMARY OF LABORATORY TEST RESULTS**  
 Los Osos Wastewater Project  
 Los Osos, California



EXPLORATION	DEPTH, ft	SAMPLE NUMBER	MATERIAL DESCRIPTION	U <sub>WW</sub> pcf	U <sub>DW</sub> pcf	MC% %	FINES %	ATTERBERG LIMITS		COMPACTION TEST			DIRECT SHEAR		COMPRESSIVE STRENGTH TESTS		CORROSIVITY TESTS				PERMEABILITY (ft/min)	SAND EQUIVALENT (SE)	COMMENTS
								LL	PI	MAX DD %	OPT MC %	C ksf	PHI deg	Q <sub>u</sub> ksf	S <sub>u</sub> (Cell Pres.) ksf	R	PH	Cl	SO <sub>4</sub>				
P-SP3	4.5	1	Poorly-graded SAND (SP)	115	107	8	1																
S	0.0	S-A	Poorly graded GRAVEL (GP)																				
S	3.5	S-1	Poorly graded SAND (SP)	100	97	3																	
S	4.0	S-4	Poorly graded SAND (SP)																				
TH-1	19.5		Poorly-graded SAND with silt (SP-SM)	109	108	1	11																
TH-2	9.0		Poorly-graded SAND (SP)	115	110	5																	
TH-3	19.0		Poorly-graded SAND (SP)	115	110	4																	
TH-3	29.0		SAND with silt (SP-SM)	113	109	4	10																
TH-4	30.0		Lean CLAY (CL)	136	109	25																	
TH-5	29.0		Poorly-graded SAND (SP)	112	109	3	1																
TH-5	39.0		Poorly-graded SAND (SP)	114	100	14	2																
TH-5	44.0		SILTY SAND (SM)			18	13																

**Classification Tests**  
 U<sub>WW</sub> = Unit Wet Weight  
 U<sub>DW</sub> = Unit Dry Weight  
 MC = Moisture Content  
 Fines = % Passing #200 Sieve  
 LL = Liquid Limit  
 PI = Plasticity Index

**Direct Shear Test**  
 C = Assigned Cohesion, ksf  
 PHI = Assigned Friction Angle, degrees

**Compaction Test**  
 MAX DD = Maximum Dry Density  
 OPT MC = Optimum Moisture Content

**Compressive Strength Tests**  
 Q<sub>u</sub> = Unconfined Compression  
 S<sub>u</sub> = Undrained Shear Strength  
 u = Unconsolidated Undrained  
 p = Pocket Penetrometer  
 t = Torvane  
 m = Miniature Vane

**Corrosivity Tests**  
 R = Resistivity, ohm-cm, sat'd.  
 PH = pH  
 Cl = Chloride, ppm  
 SO<sub>4</sub> = Sulfate, ppm

**SUMMARY OF LABORATORY TEST RESULTS**  
 Los Osos Wastewater Project  
 Los Osos, California



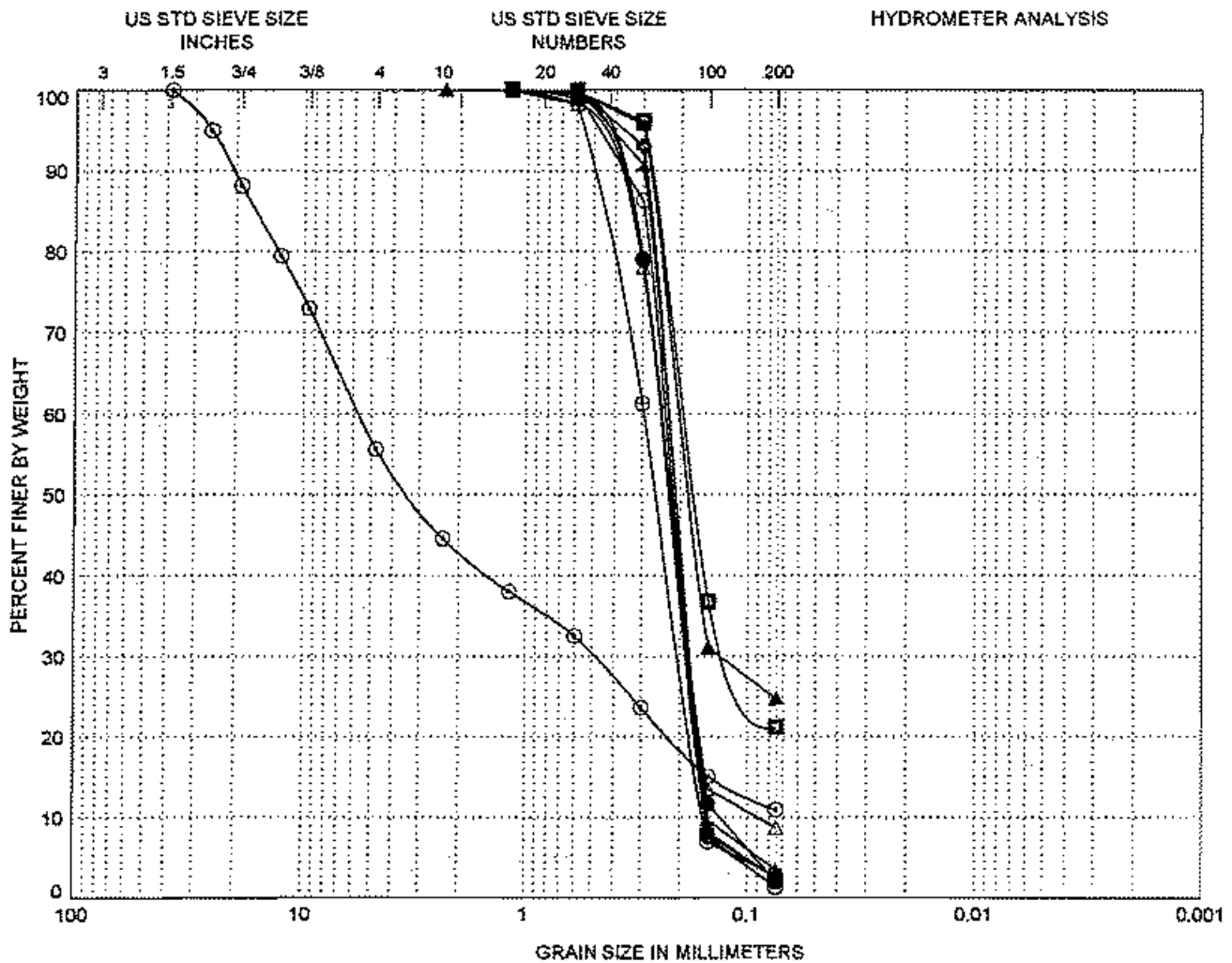

GRAVEL		SAND			SILT or CLAY
Coarse	Fine	Coarse	Medium	Fine	

LEGEND		
	(location)	(depth,ft)
○	DH-401	4.0
●	DH-402	14.0
△	DH-404	9.0
▲	DH-406	19.0
⊙	DH-406	29.0
⊕	DH-409	2.0
▲	DH-411	1.5
■	DH-412	9.0
⊕	HP-1	19.5
⊕	HP-1	39.5

CLASSIFICATION	Cc	Cu
Poorly graded SAND (SP)	0.9	1.6
Poorly graded SAND (SP)	1.0	1.9
Poorly graded SAND with silt (SP-SM)	1.4	2.8
Clayey SAND (SC)		
SAND with clay and gravel (SP-SC)	0.7	88.7
Poorly graded SAND (SP)	0.9	1.5
Poorly graded SAND (SP)	0.9	1.5
Silty SAND (SM)		
Poorly-graded SAND (SP)	0.9	1.6
Poorly-graded SAND (SP)	0.9	1.9

**GRAIN SIZE CURVES**  
Los Osos Wastewater Project  
Los Osos, California

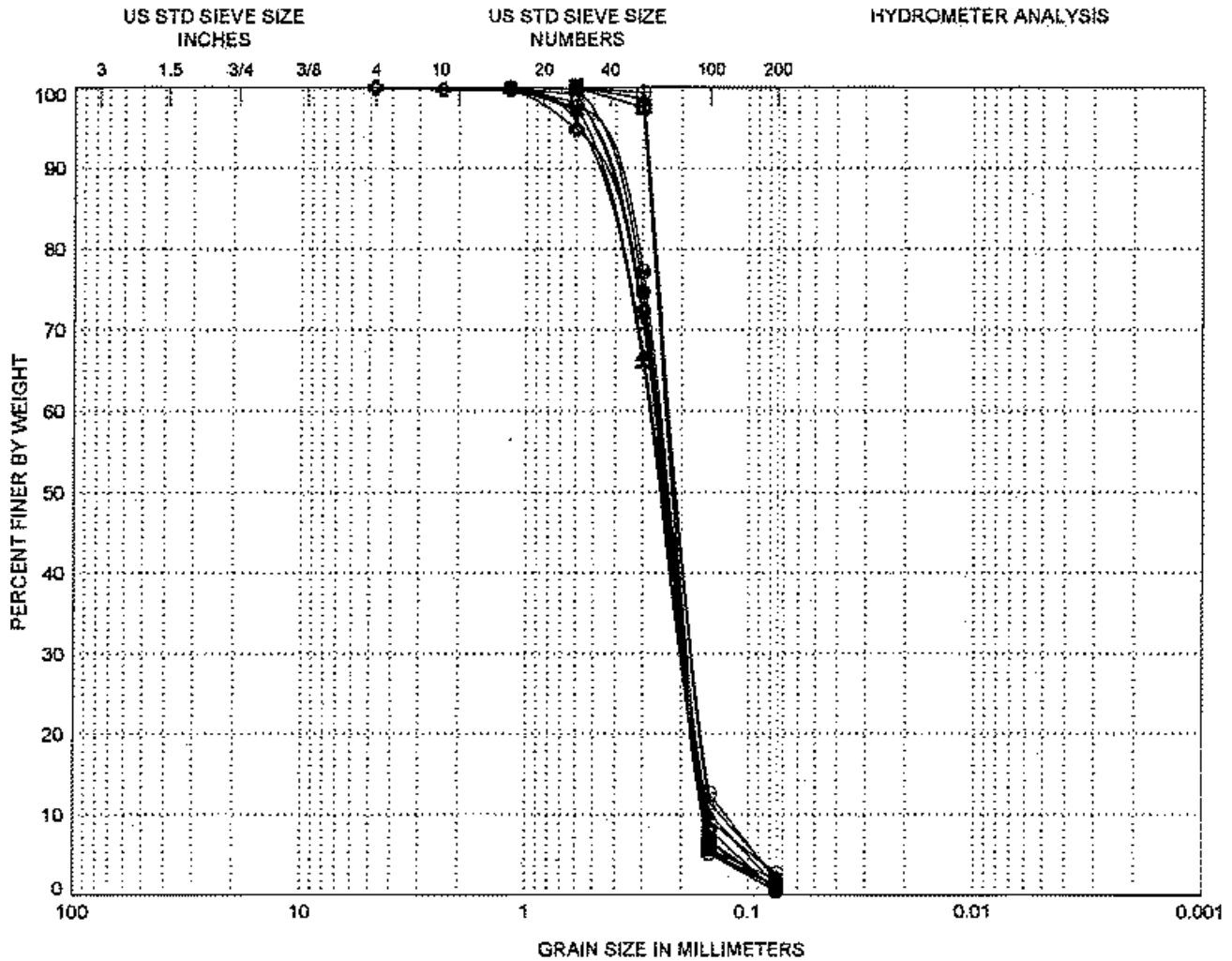

GRAVEL		SAND			SILT or CLAY
Coarse	Fine	Coarse	Medium	Fine	

LEGEND			CLASSIFICATION	C <sub>c</sub>	C <sub>u</sub>
(location)	(depth, ft)				
○	HP-1	49.5	Poorly-graded SAND (SP)	0.9	1.7
●	HP-2	49.0	Poorly-graded SAND (SP)	0.9	1.7
△	L-3	4.5	Poorly-graded SAND (SP)	1.0	1.6
▲	P-2	4.8	Poorly-graded SAND (SP)	0.9	1.9
⊙	P-8	4.8	Poorly-graded SAND (SP)	0.9	1.7
⊗	P-10	4.9	Poorly-graded SAND (SP)	0.9	1.7
▲	P-14	5.0	Poorly-graded SAND (SP)	0.9	1.8
⊠	P-17	4.5	Poorly-graded SAND (SP)	0.9	1.5
⊗	P-24	4.5	Poorly-graded SAND (SP)	0.9	1.6
⊕	P-28	4.5	Poorly-graded SAND (SP)	1.1	1.7

**GRAIN SIZE CURVES**  
Los Osos Wastewater Project  
Los Osos, California

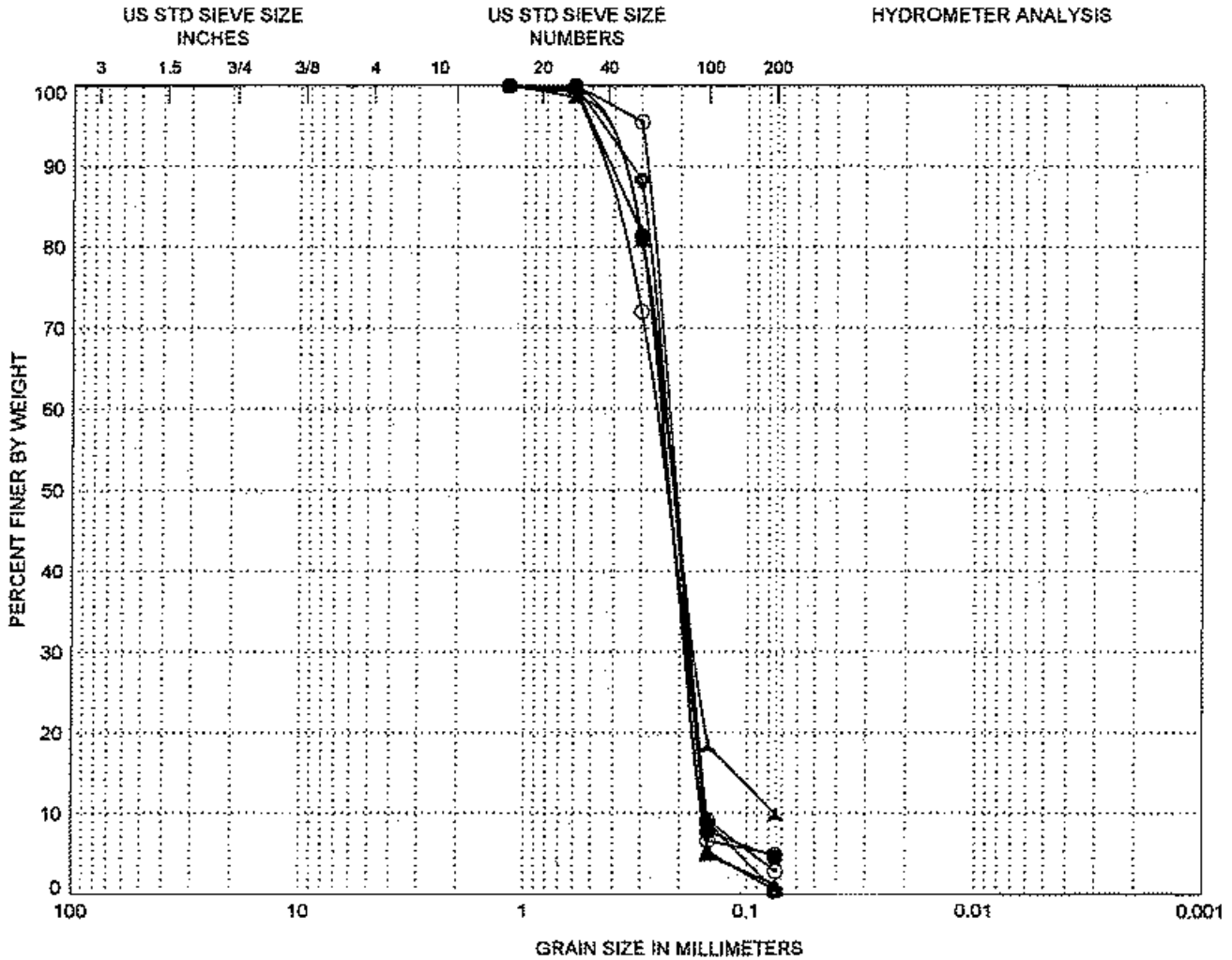

GRAVEL		SAND			SILT or CLAY
Coarse	Fine	Coarse	Medium	Fine	

LEGEND		
(location)	(depth,ft)	
○	P-3W1	4.5
●	P-3W2	4.5
△	P-3W3	4.5
▲	P-SP1	4.5
⊙	P-SP2	4.5
⊗	P-SP3	4.5
▲	TH-3	29.0

CLASSIFICATION	C <sub>c</sub>	C <sub>u</sub>
Poorly-graded SAND (SP)	0.9	1.7
Poorly-graded SAND (SP)	0.9	1.6
Poorly-graded SAND (SP)	0.9	1.6
Poorly-graded SAND (SP)	0.9	1.6
Poorly-graded SAND (SP)	0.9	1.5
Poorly-graded SAND (SP)	0.9	1.5
SAND with silt (SP-SM)	1.6	3.1

**GRAIN SIZE CURVES**  
 Los Osos Wastewater Project  
 Los Osos, California

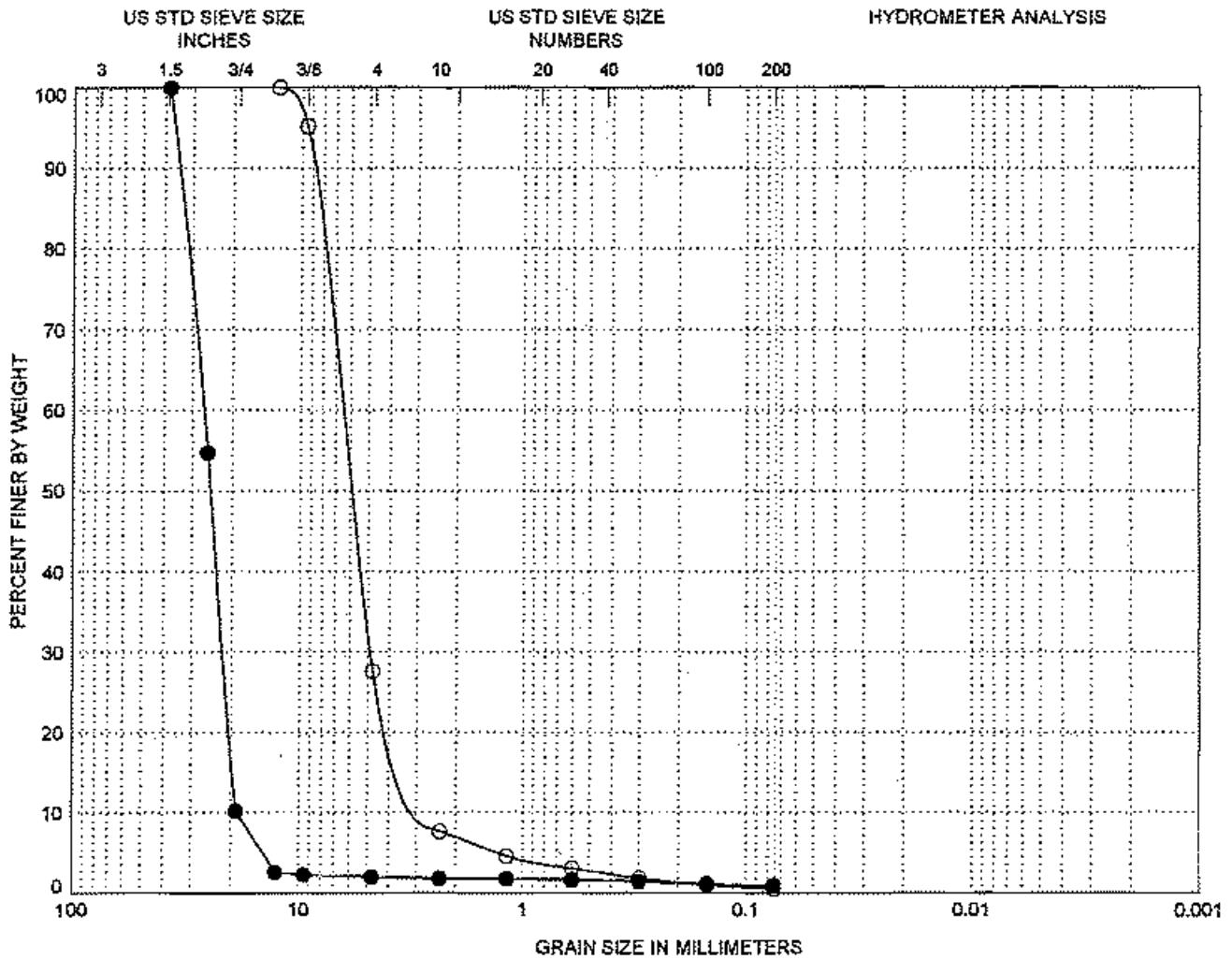

GRAVEL		SAND			SILT or CLAY
Coarse	Fine	Coarse	Medium	Fine	

LEGEND		CLASSIFICATION	Cc	Cu	
(location)	(depth,ft)				
○	DW-1	0.0	Poorly-graded GRAVEL with sand (GP) - Drywell	1.4	2.6
●	S	0.0	Poorly graded GRAVEL (GP) - Percolation Line	0.9	1.4

**GRAIN SIZE CURVES**  
 Los Osos Wastewater Project  
 Los Osos, California



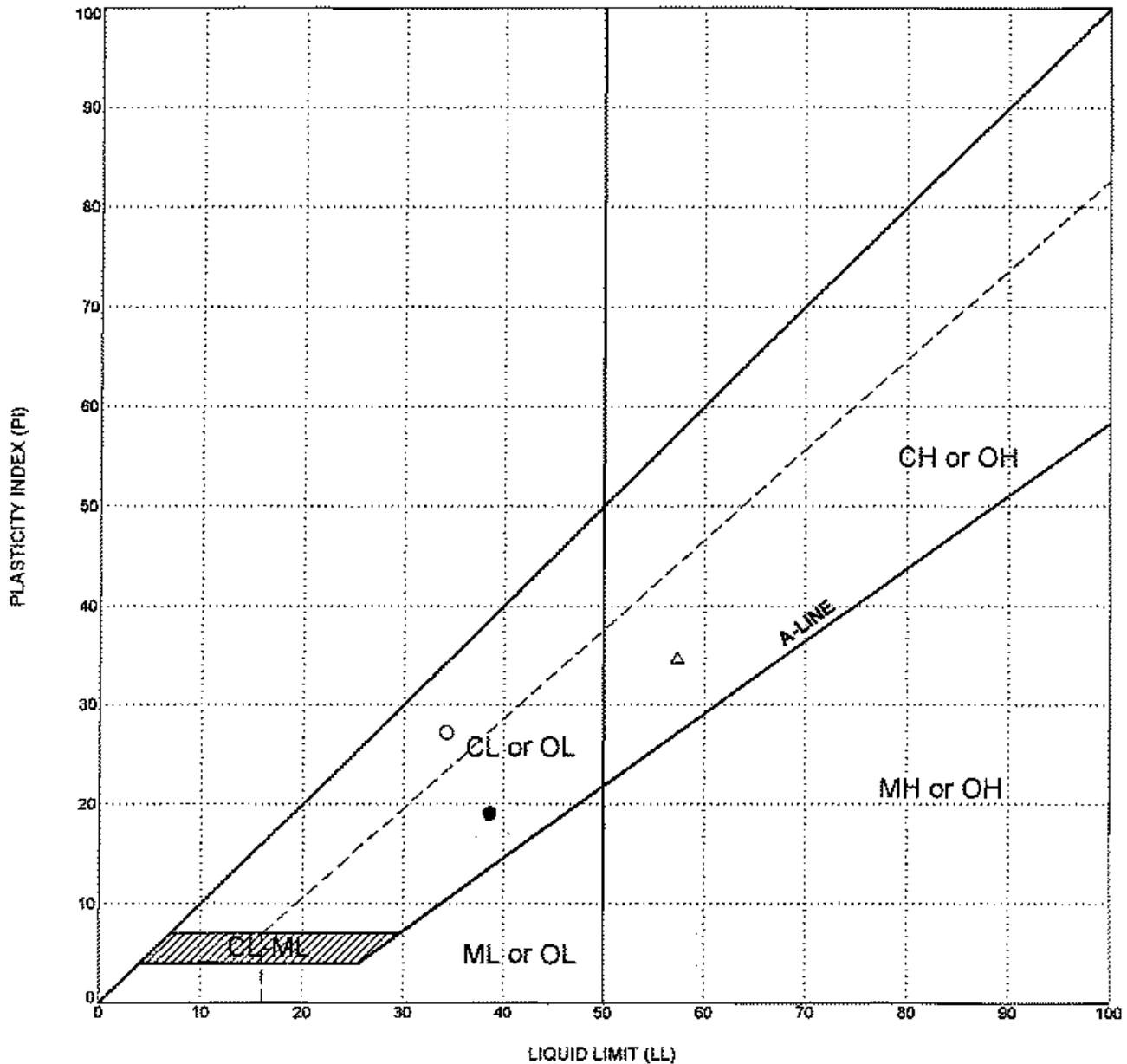

LEGEND			CLASSIFICATION			ATTERBERG LIMITS TEST RESULTS		
location	depth, ft			LIQUID LIMIT (LL)	PLASTIC LIMIT (PL)	PLASTICITY INDEX (PI)		
○	DH-406	24.0	Lean CLAY (CL)	34	7	27		
●	DH-406	34.0	Lean CLAY (CL)	39	20	19		
△	HA-401	8.0	Fat CLAY (CH)	57	22	35		

**PLASTICITY CHART**  
 Los Osos Wastewater Project  
 Los Osos, California

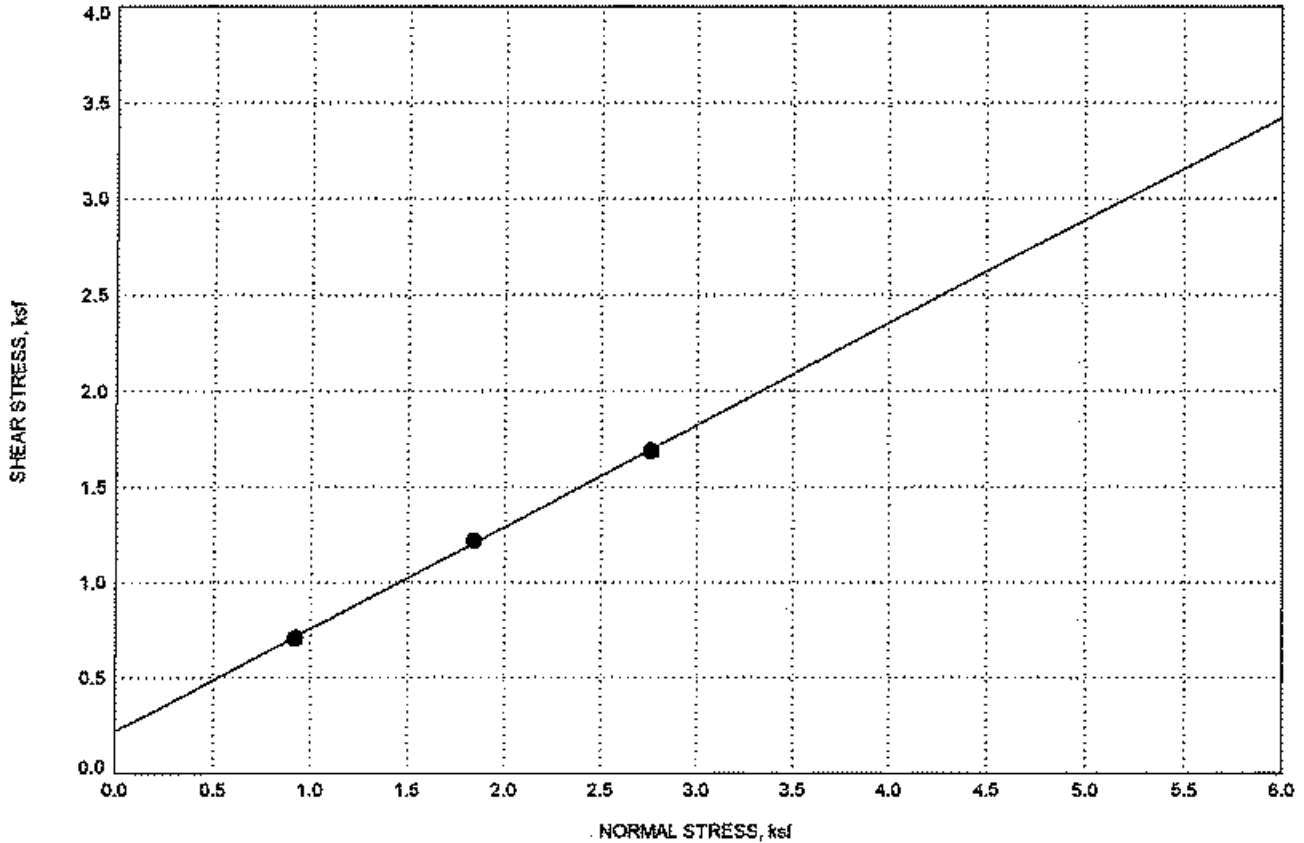

COHESION, ksf 0.2

ANGLE OF INTERNAL FRICTION, deg 28

LOCATION DH-404

DEPTH, ft 3-6

MOISTURE CONTENT, % 7.5

UNIT DRY WEIGHT, pcf 99.5

MATERIAL DESCRIPTION Poorly graded SAND with silt (SP-SM)

SAMPLE CONDITION Remold to 90 % R.C.

**DIRECT SHEAR TEST RESULTS**

Los Osos Wastewater Project

Los Osos, California

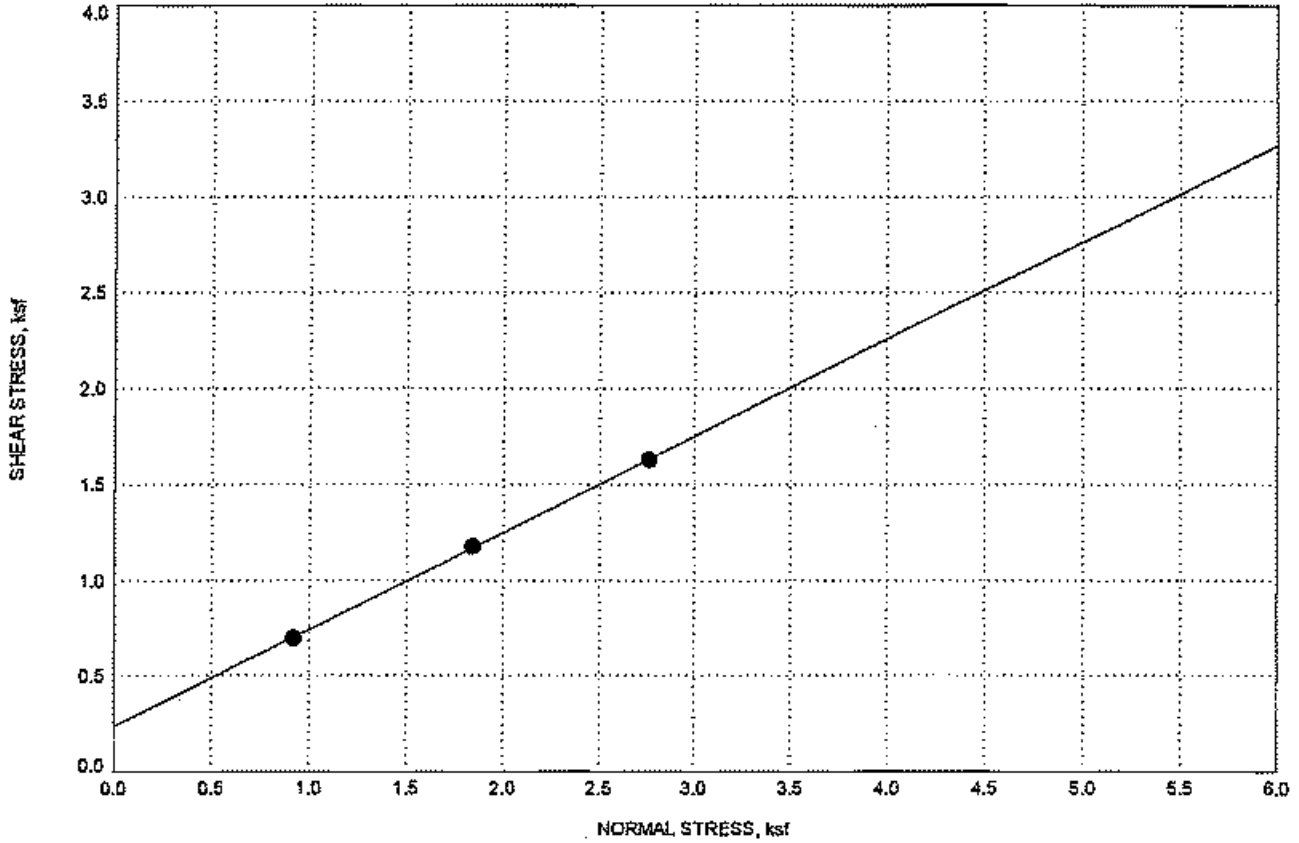

COHESION, ksf	0.2
ANGLE OF INTERNAL FRICTION, deg	27
LOCATION	DH-405
DEPTH, ft	2-5
MOISTURE CONTENT, %	7.0
UNIT DRY WEIGHT, pcf	99.5
MATERIAL DESCRIPTION	Poorly graded SAND (SP)
SAMPLE CONDITION	Remold to 90 % R.C.

**DIRECT SHEAR TEST RESULTS**  
 Los Osos Wastewater Project  
 Los Osos, California

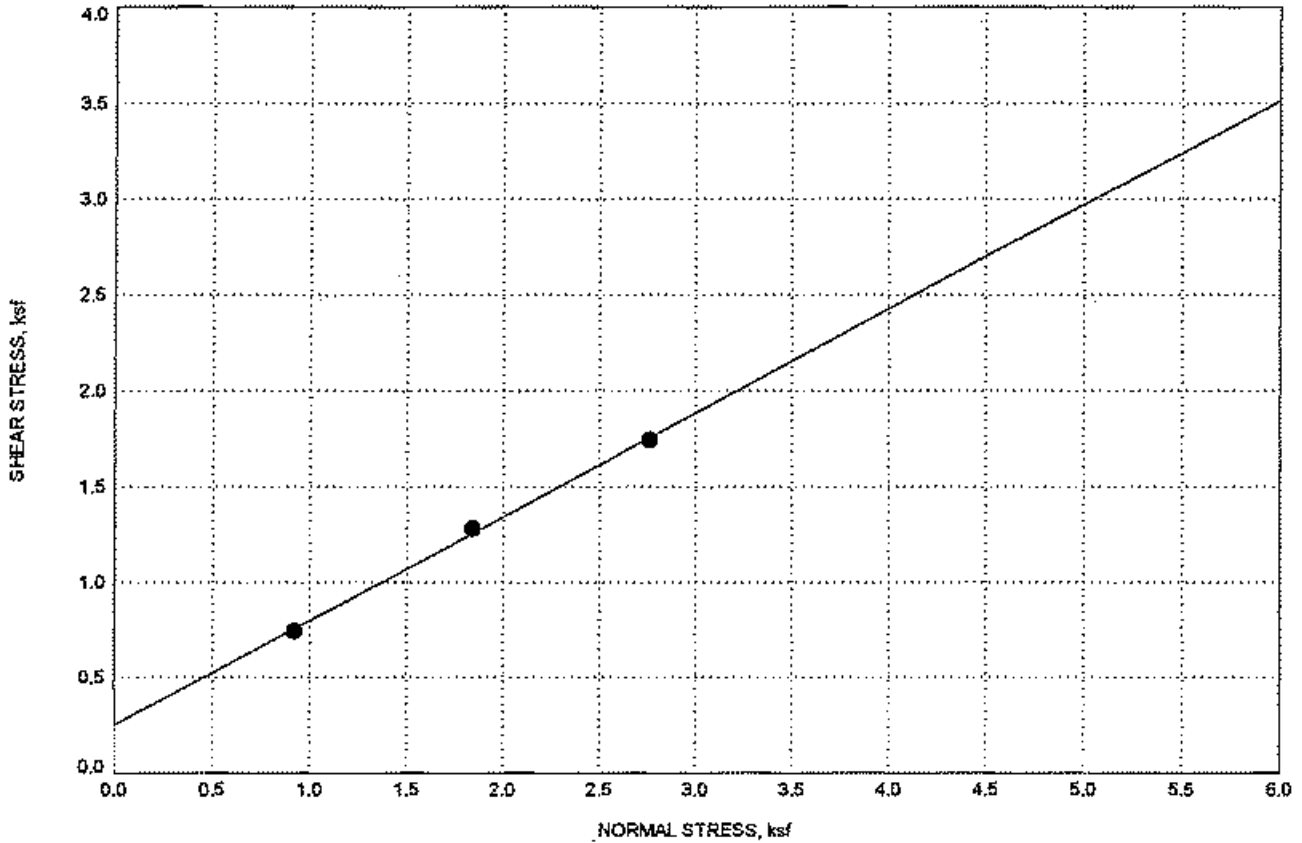

COHESION, ksf	0.3
ANGLE OF INTERNAL FRICTION, deg	29
LOCATION	HA-401
DEPTH, ft	2-5
MOISTURE CONTENT, %	8.5
UNIT DRY WEIGHT, pcf	96.8
MATERIAL DESCRIPTION	SAND with silt (SP-SM)
SAMPLE CONDITION	Remold to 90 % R.C.

**DIRECT SHEAR TEST RESULTS**  
 Los Osos Wastewater Project  
 Los Osos, California





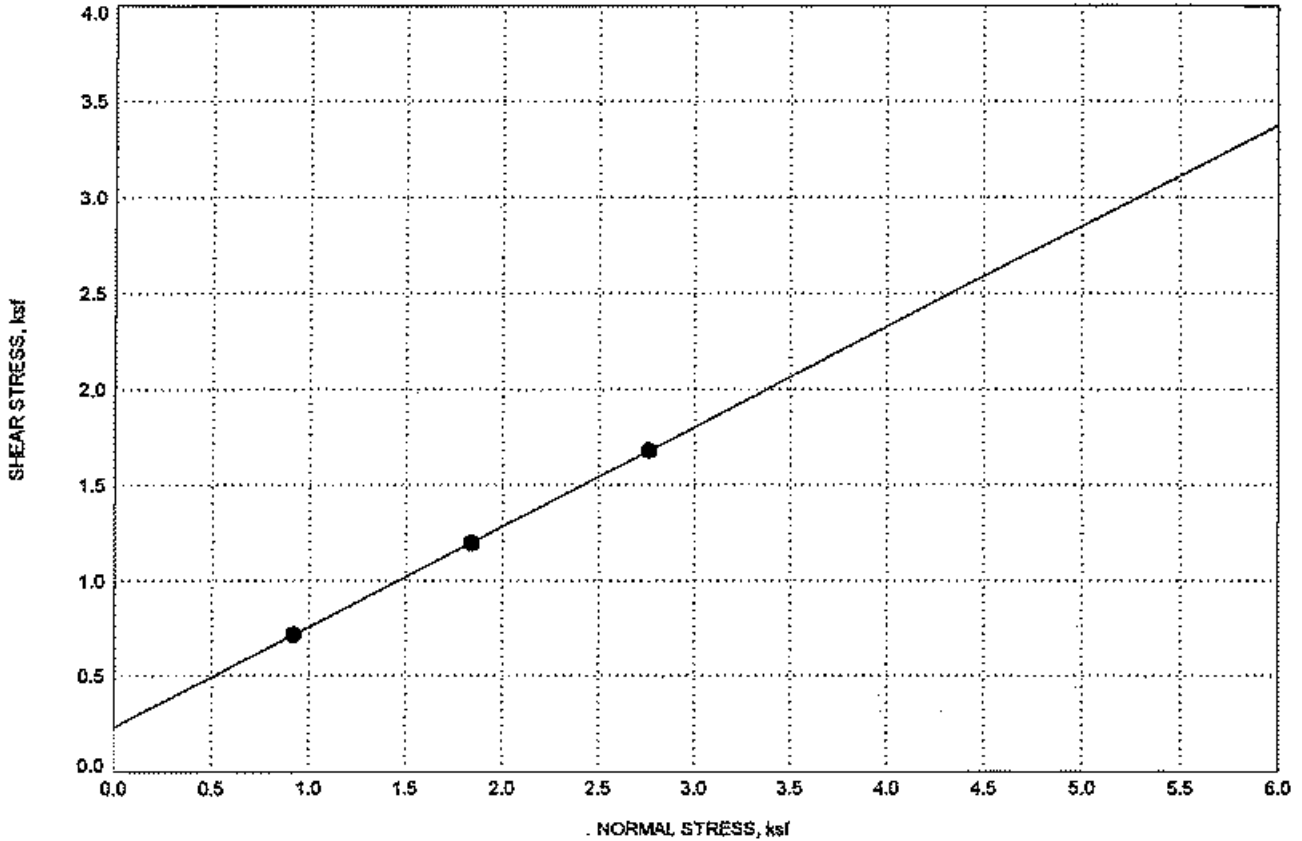

COHESION, ksf	0.2
ANGLE OF INTERNAL FRICTION, deg	28
LOCATION	HA-403
DEPTH, ft	0.5-5
MOISTURE CONTENT, %	6.0
UNIT DRY WEIGHT, pcf	98.1
MATERIAL DESCRIPTION	SAND with silt (SP-SM)
SAMPLE CONDITION	Remold to 90 % R.C.

**DIRECT SHEAR TEST RESULTS**  
 Los Osos Wastewater Project  
 Los Osos, California

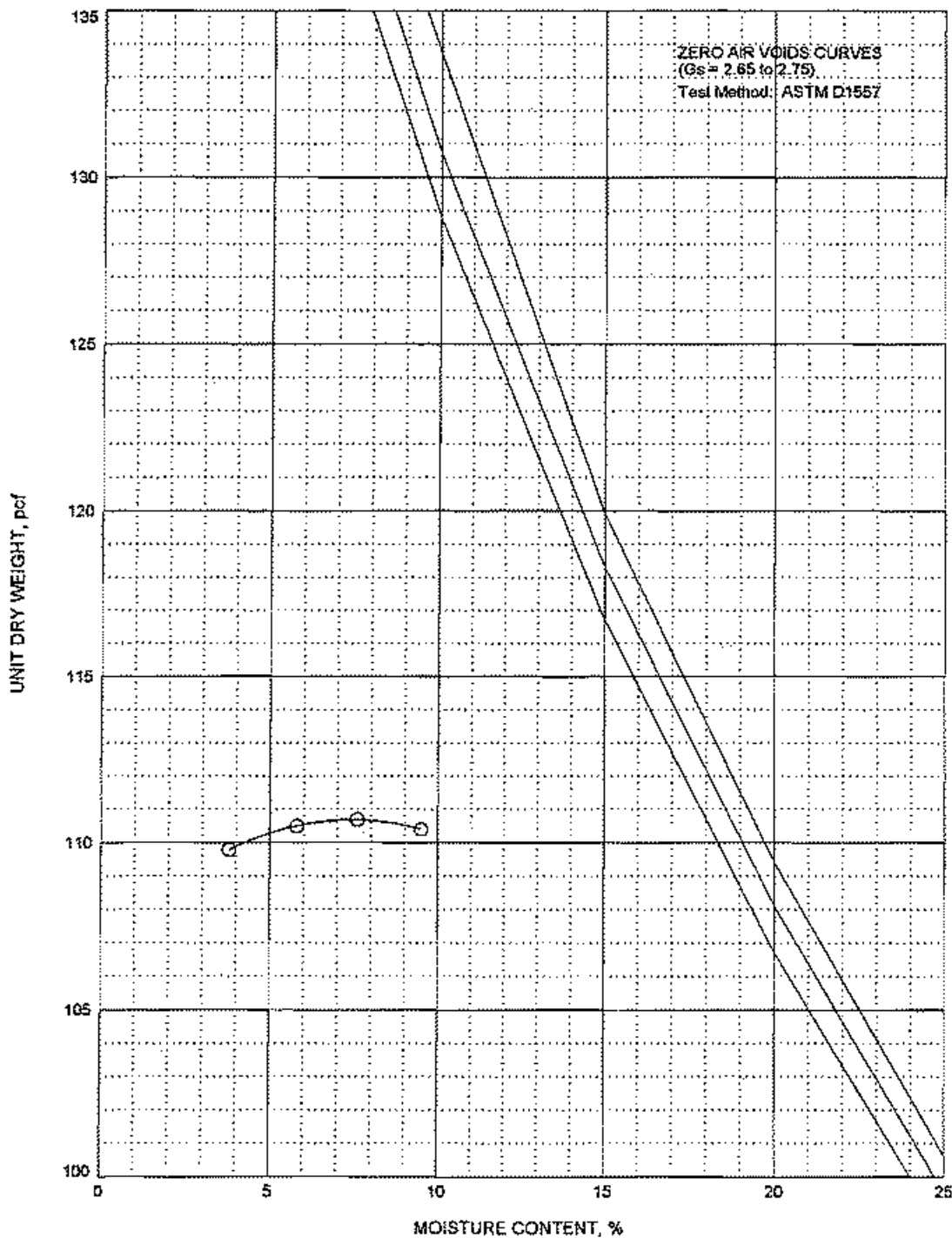

<u>LEGEND</u>		<u>CLASSIFICATION</u>	<u>MAXIMUM UNIT DRY WEIGHT, pcf</u>	<u>OPTIMUM WATER CONTENT, %</u>
(location)	depth, ft			
○ DH-404	3.0	Poorly graded SAND with silt (SP-SM)	110.5	7.5

**COMPACTION TEST RESULTS**  
 Los Osos Wastewater Project  
 Los Osos, California

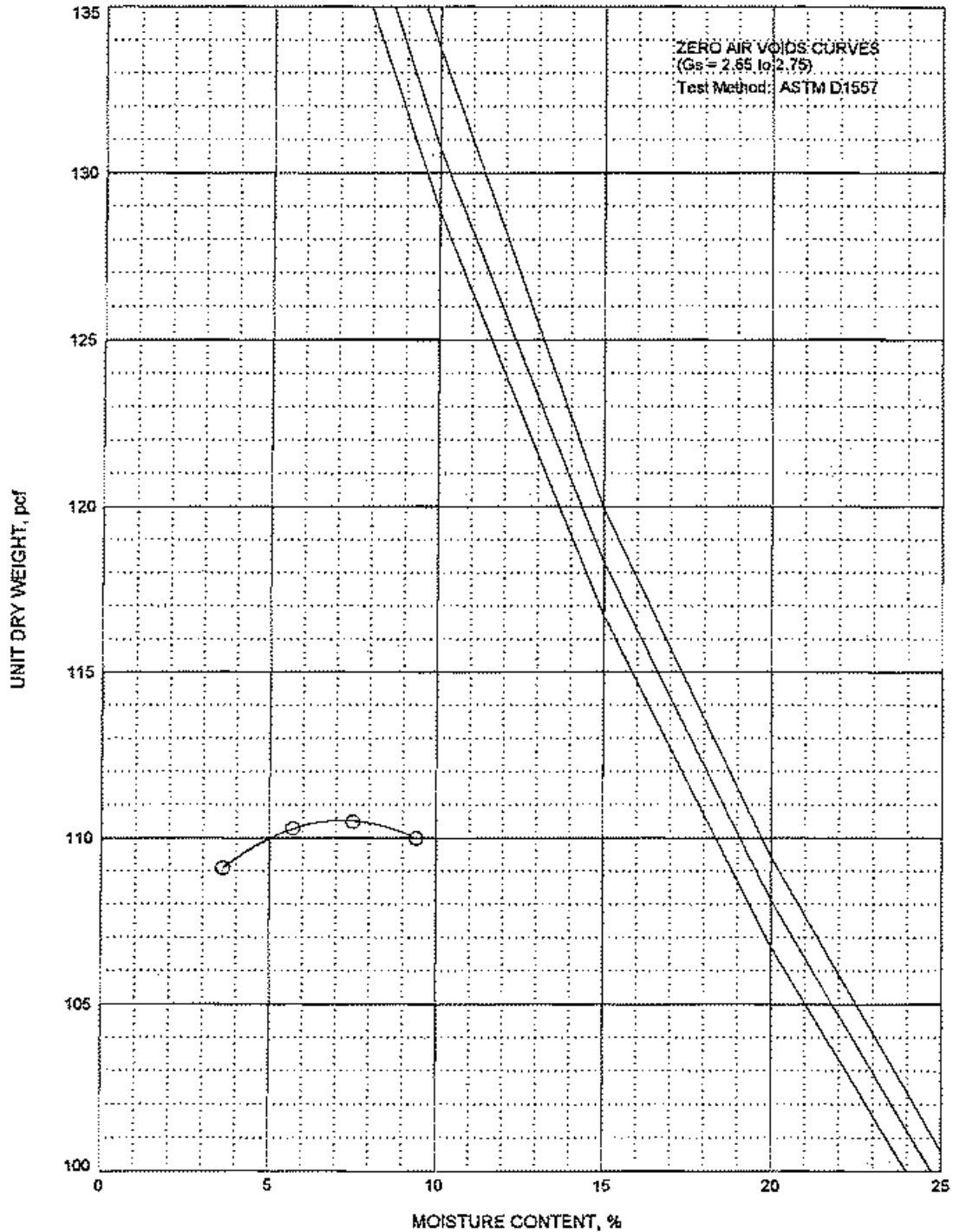

**LEGEND**  
 (location) depth, ft  
 ○ DH-405 2.0

**CLASSIFICATION**  
 Poorly graded SAND (SP)

**MAXIMUM UNIT DRY WEIGHT, pcf**  
 110.5

**OPTIMUM WATER CONTENT, %**  
 7.0

**COMPACTION TEST RESULTS**  
 Los Osos Wastewater Project  
 Los Osos, California



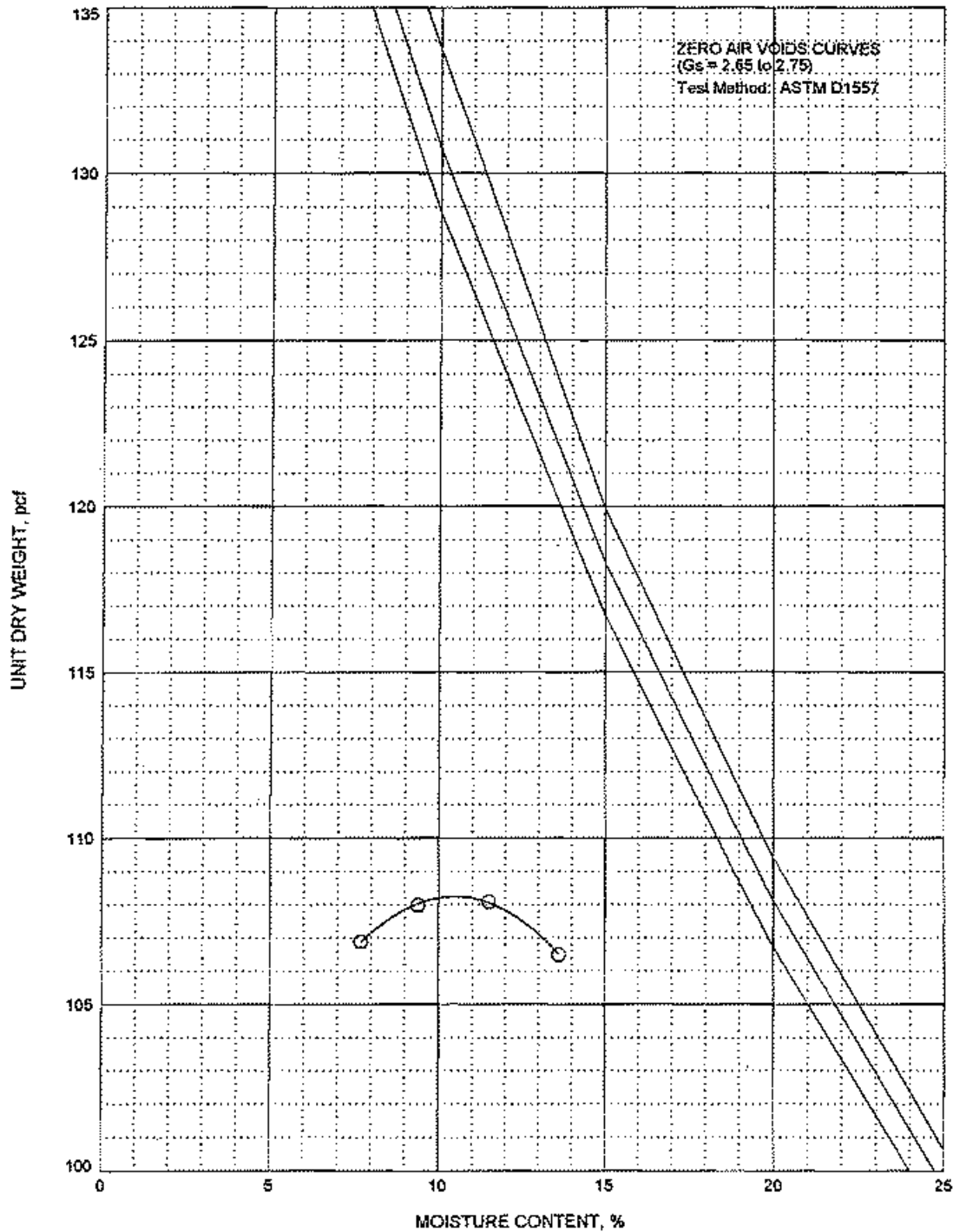

<u>LEGEND</u>		<u>CLASSIFICATION</u>	<u>MAXIMUM UNIT DRY WEIGHT, pcf</u>	<u>OPTIMUM WATER CONTENT, %</u>
(location)	depth, ft			
○ DH-407	7.0	Poorly graded SAND (SP)	108.0	10.5

**COMPACTION TEST RESULTS**  
 Los Osos Wastewater Project  
 Los Osos, California

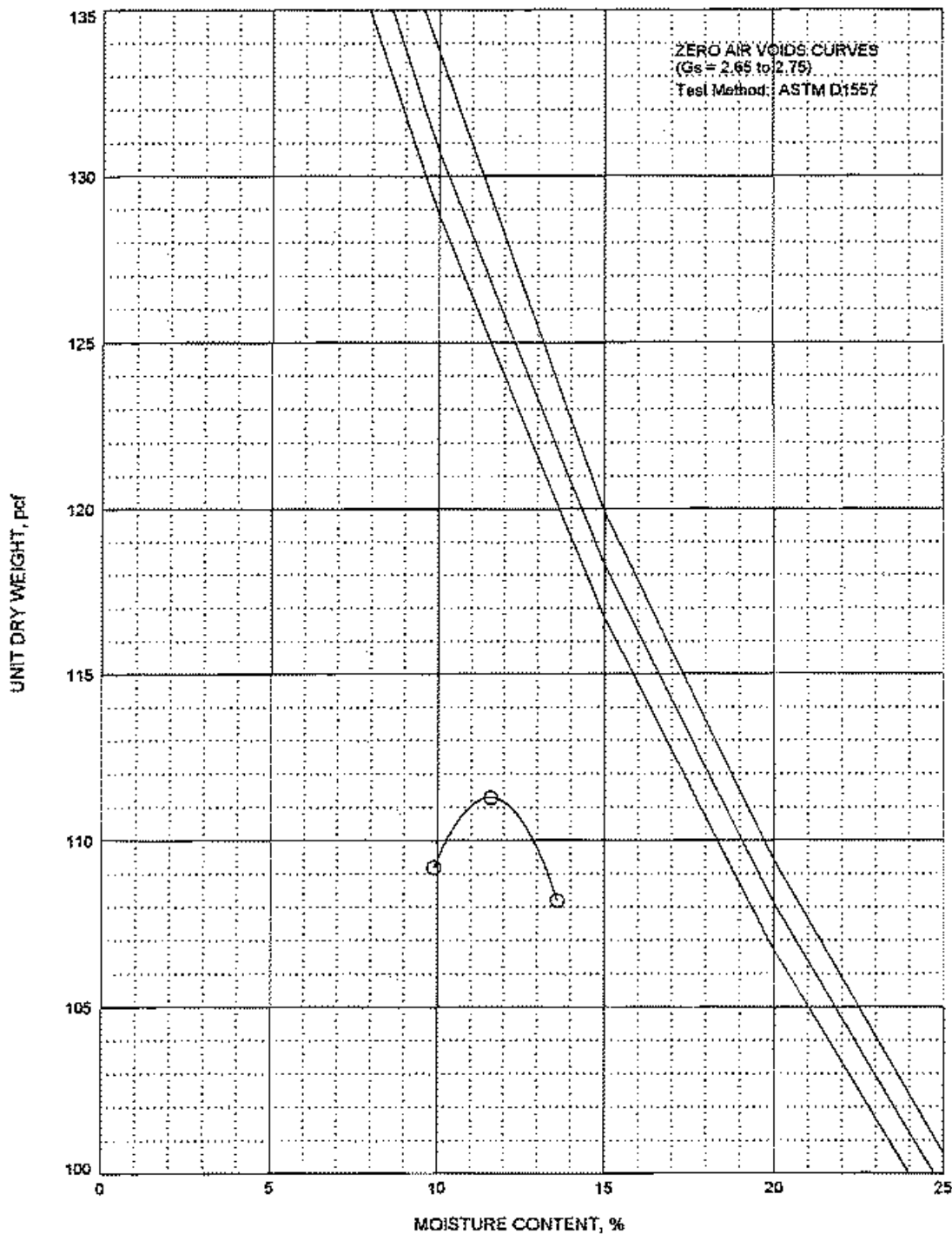

**LEGEND**  
 (location) depth, ft  
 ○ DH-411 4.0

**CLASSIFICATION**  
 Poorly graded SAND (SP)

**MAXIMUM UNIT DRY WEIGHT, pcf**  
 111.5

**OPTIMUM WATER CONTENT, %**  
 11.5

**COMPACTION TEST RESULTS**  
 Los Osos Wastewater Project  
 Los Osos, California

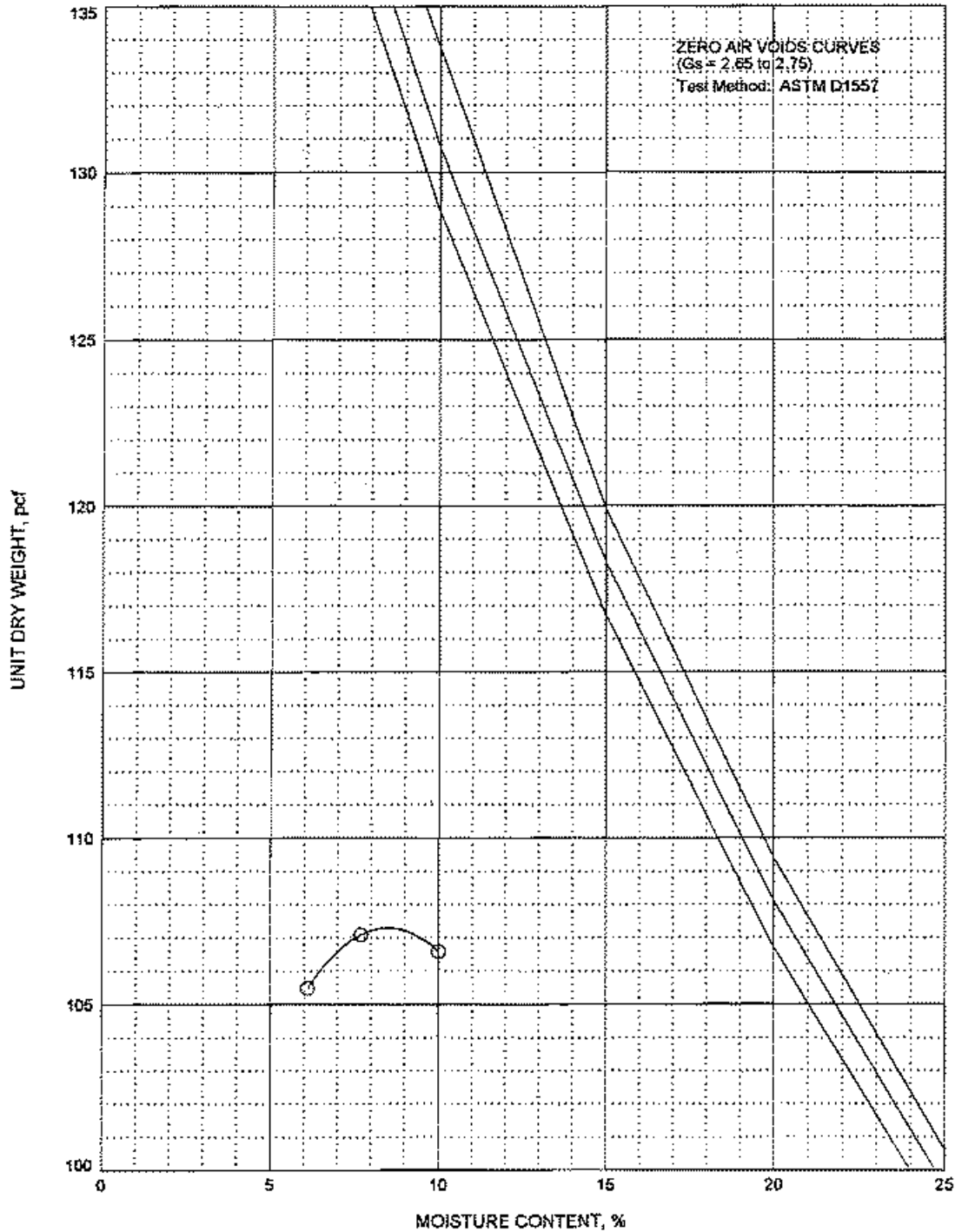

**LEGEND**

(location) depth, ft  
 ○ HA-401 2.0

**CLASSIFICATION**

SAND with silt (SP-SM)

MAXIMUM UNIT  
 DRY WEIGHT, pcf

107.5

OPTIMUM WATER  
 CONTENT, %

8.5

**COMPACTION TEST RESULTS**

Los Osos Wastewater Project  
 Los Osos, California

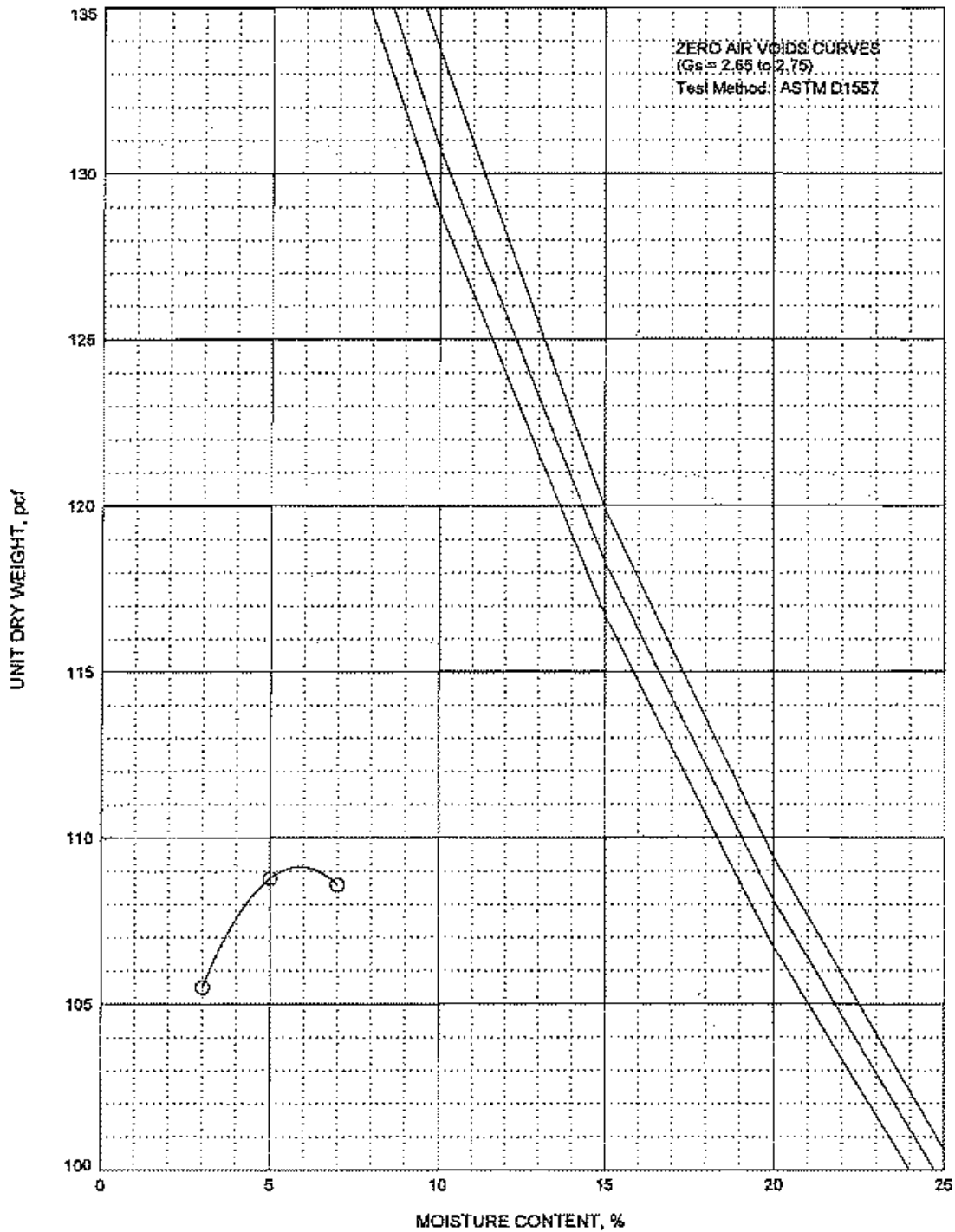

LEGEND	
(location)	depth, ft
○ HA-403	0.5

**CLASSIFICATION**  
 SAND with silt (SP-SM)

**MAXIMUM UNIT DRY WEIGHT, pcf**  
 109.0

**OPTIMUM WATER CONTENT, %**  
 6.0

**COMPACTION TEST RESULTS**  
 Los Osos Wastewater Project  
 Los Osos, California

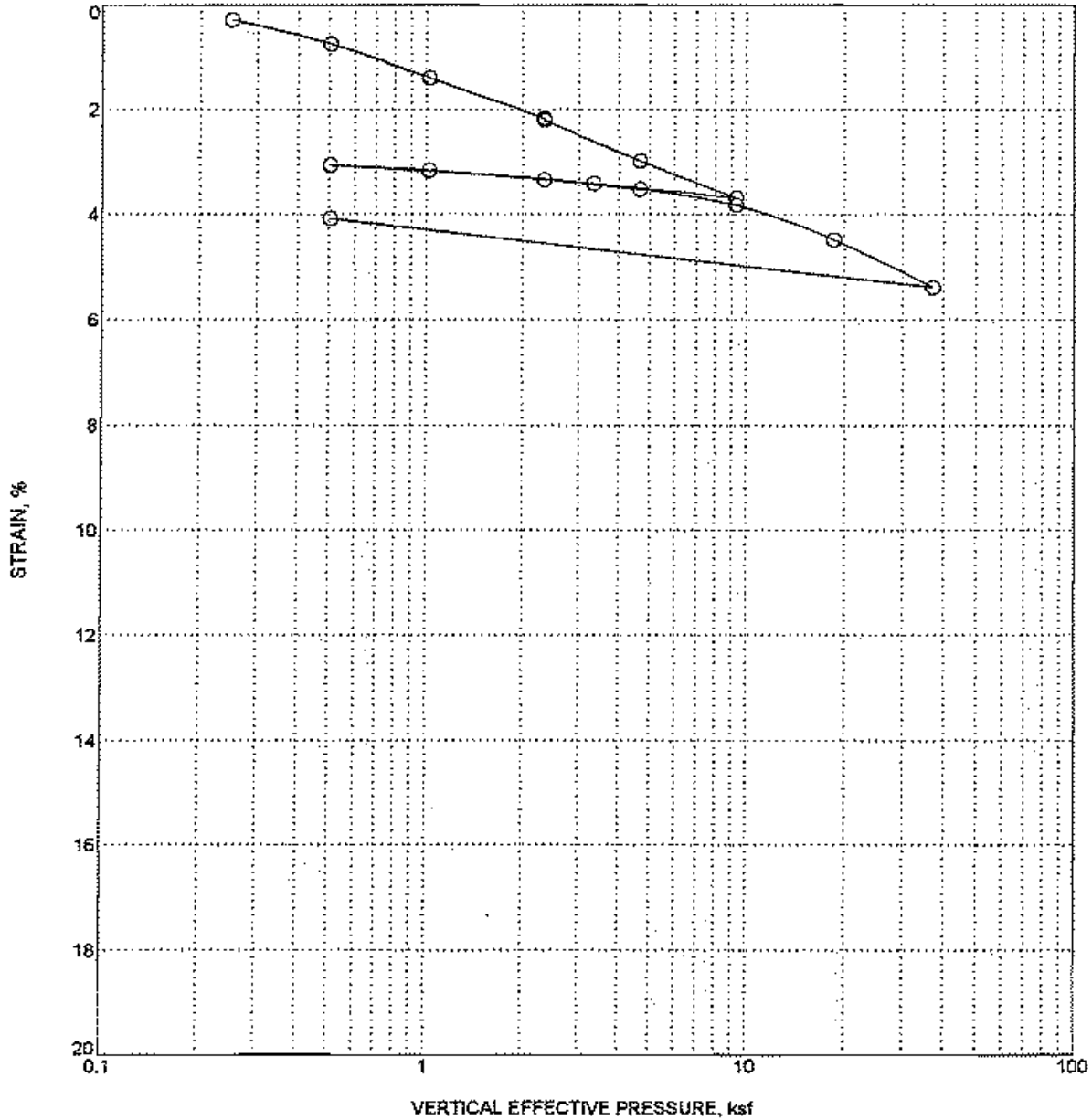

LOCATION	DH-404
DEPTH, ft	1.5
INITIAL MOISTURE CONTENT, %	2
UNIT DRY WEIGHT, pcf	103
MATERIAL DESCRIPTION	Poorly graded SAND with silt (SP-SM)
SAMPLE CONDITION	Driven Ring

**CONSOLIDATION TEST RESULTS**

Los Osos Wastewater Project  
 Los Osos, California

PLATE B-6a





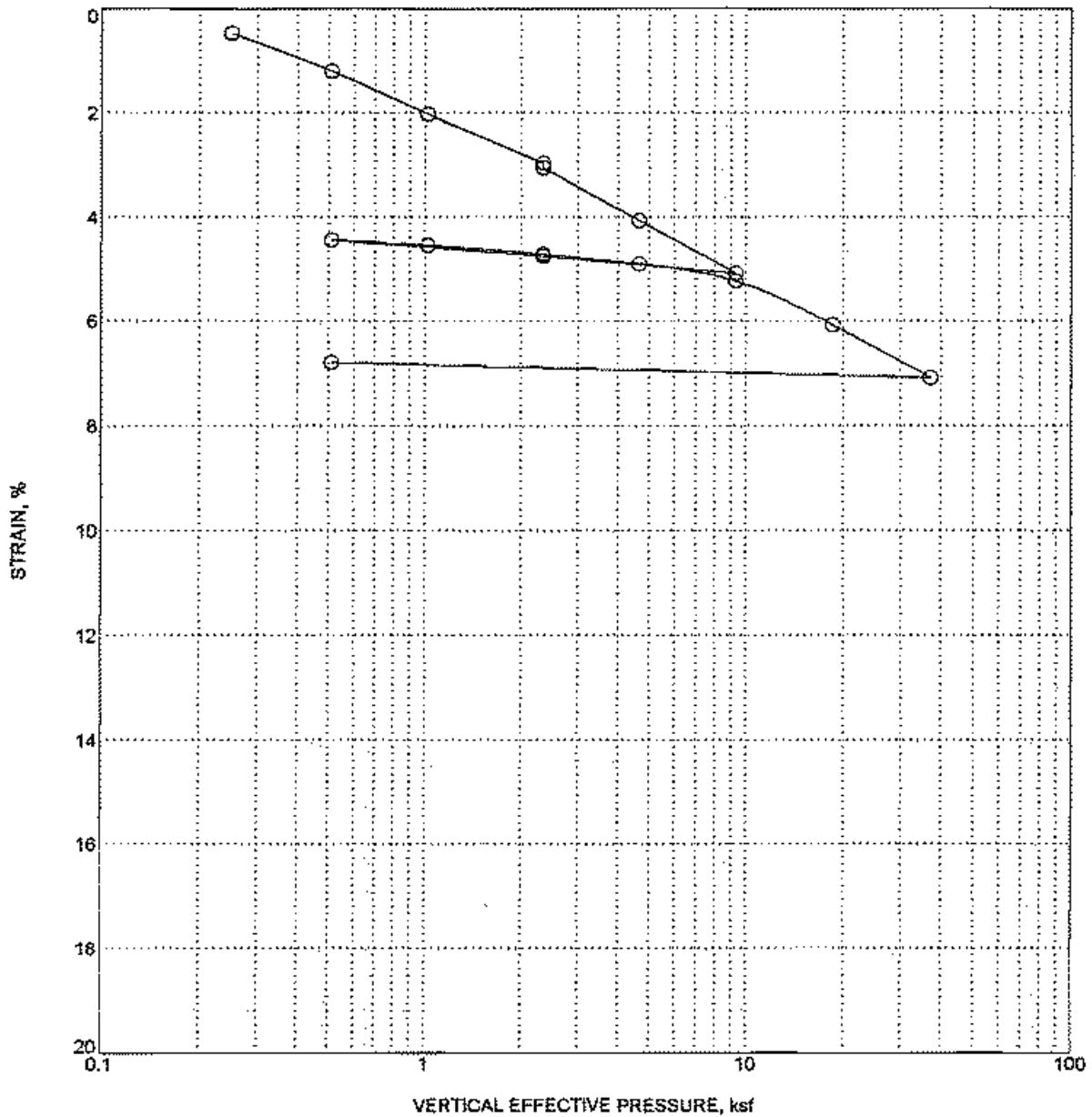

LOCATION	DH-405
DEPTH, ft	2.0
INITIAL MOISTURE CONTENT, %	4
UNIT DRY WEIGHT, pcf	102
MATERIAL DESCRIPTION	Poorly graded SAND (SP)
SAMPLE CONDITION	Driven Ring

**CONSOLIDATION TEST RESULTS**  
 Los Osos Wastewater Project  
 Los Osos, California

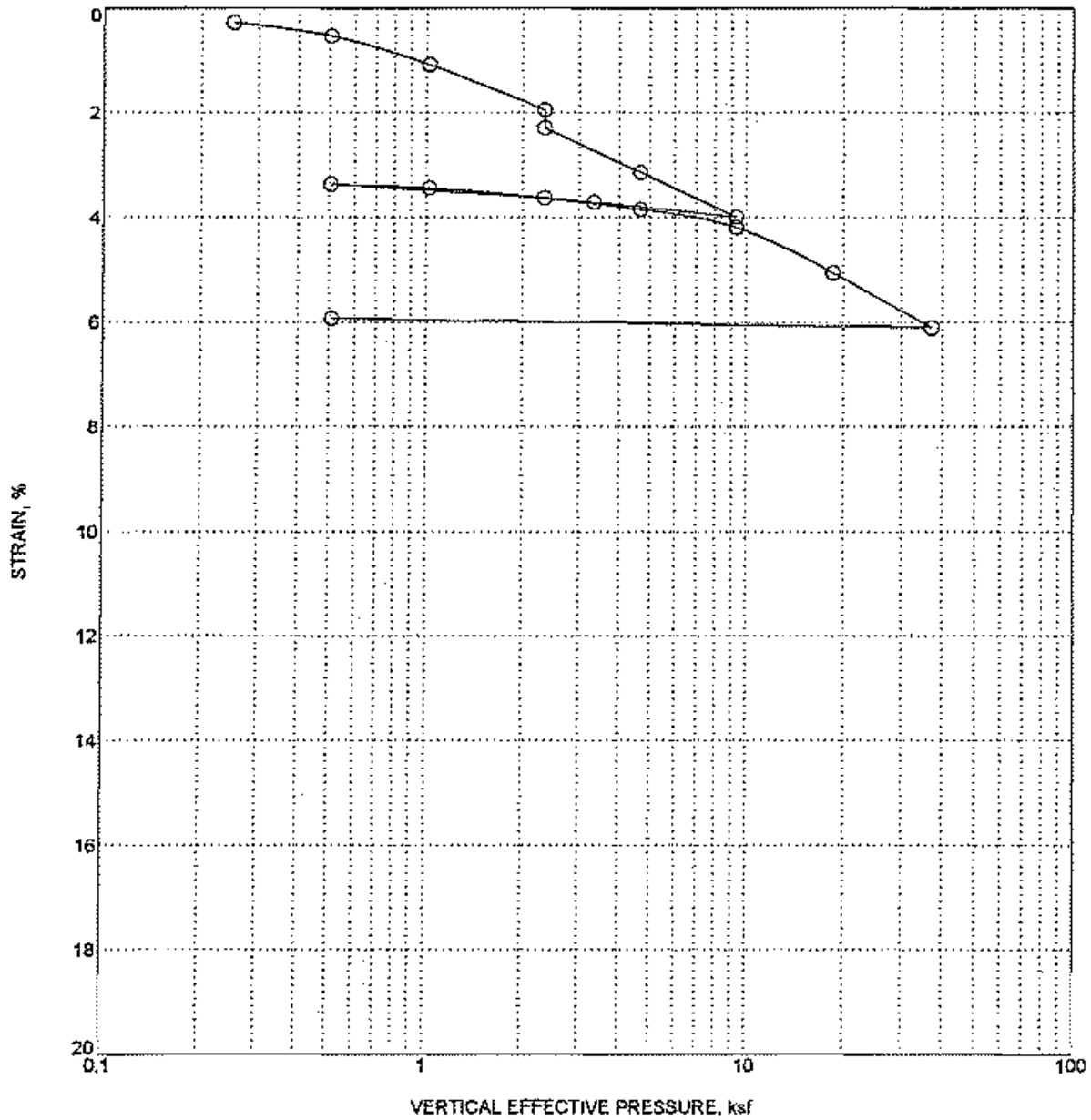

LOCATION	HA-401
DEPTH, ft	3.0
INITIAL MOISTURE CONTENT, %	3
UNIT DRY WEIGHT, pcf	102
MATERIAL DESCRIPTION	SAND with silt (SP-SM)
SAMPLE CONDITION	Driven Ring

**CONSOLIDATION TEST RESULTS**  
 Los Osos Wastewater Project  
 Los Osos, California



**APPENDIX C**

Maximum Cross-Section, SMU Wall Reinforcement Spacing = 4'. LTDS = 5000

D:\LD5030-1\SMUWAL-T\TRIALSA.PL2 Run By: Gregg Fiegel, Fugro West, Inc. 2/13/2004 2:42PM

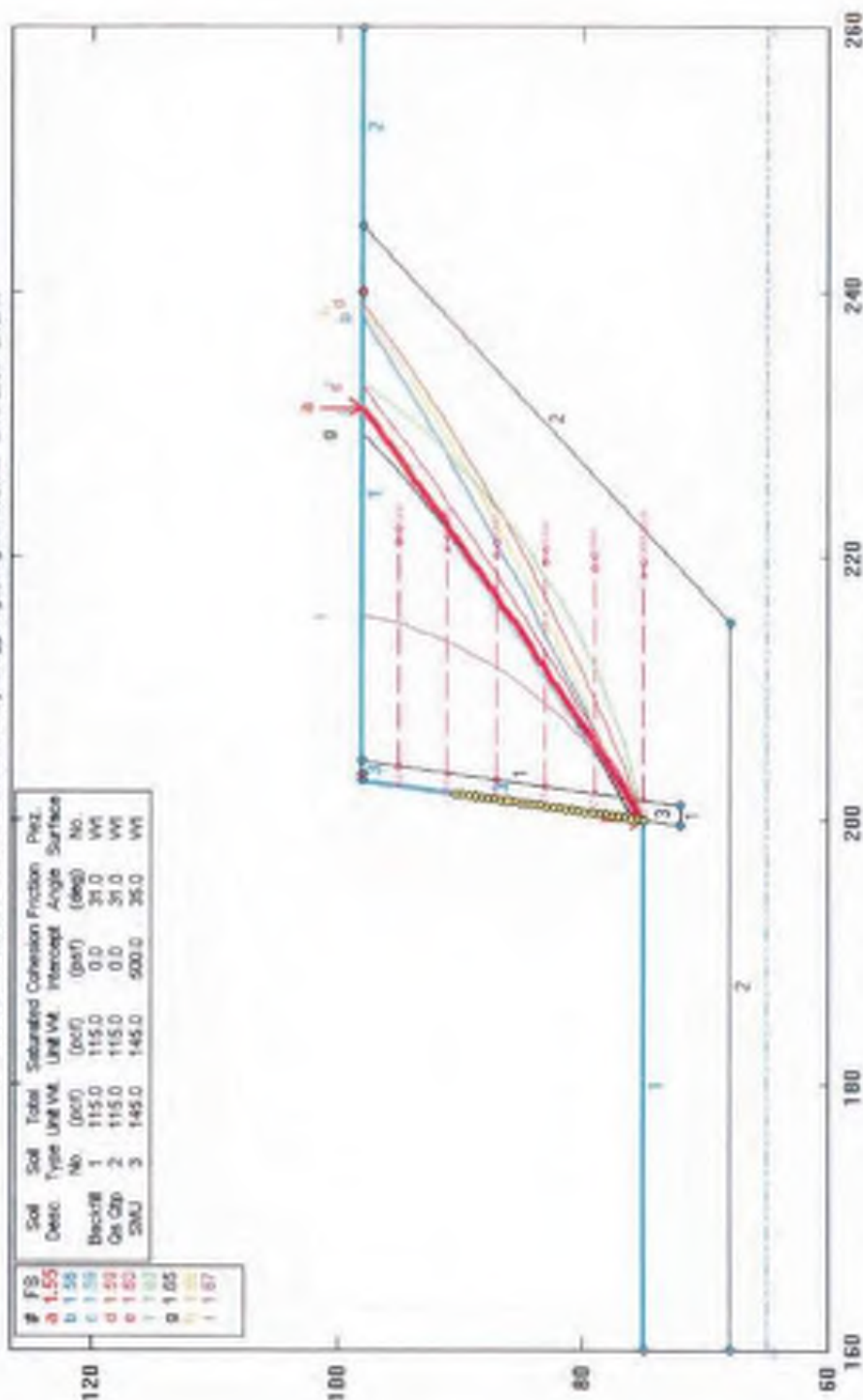

STABL6H FSmIn=1.55  
 Safety Factors Are Calculated By The Modified Bishop Method

**SLOPE STABILITY RESULTS: SMU RETAINING WALL, STATIC CASE**  
 Los Osos Wastewater Project  
 Los Osos, California

Maximum Cross-Section, SMU Wall Reinforcement Spacing = 4', LTDS = 5000

D:\LOSOS\10600\VAL-1\TSM\LA.PL2 Run By: Gregg Fiegel, Fugro West, Inc. 2/13/2004 2:50PM

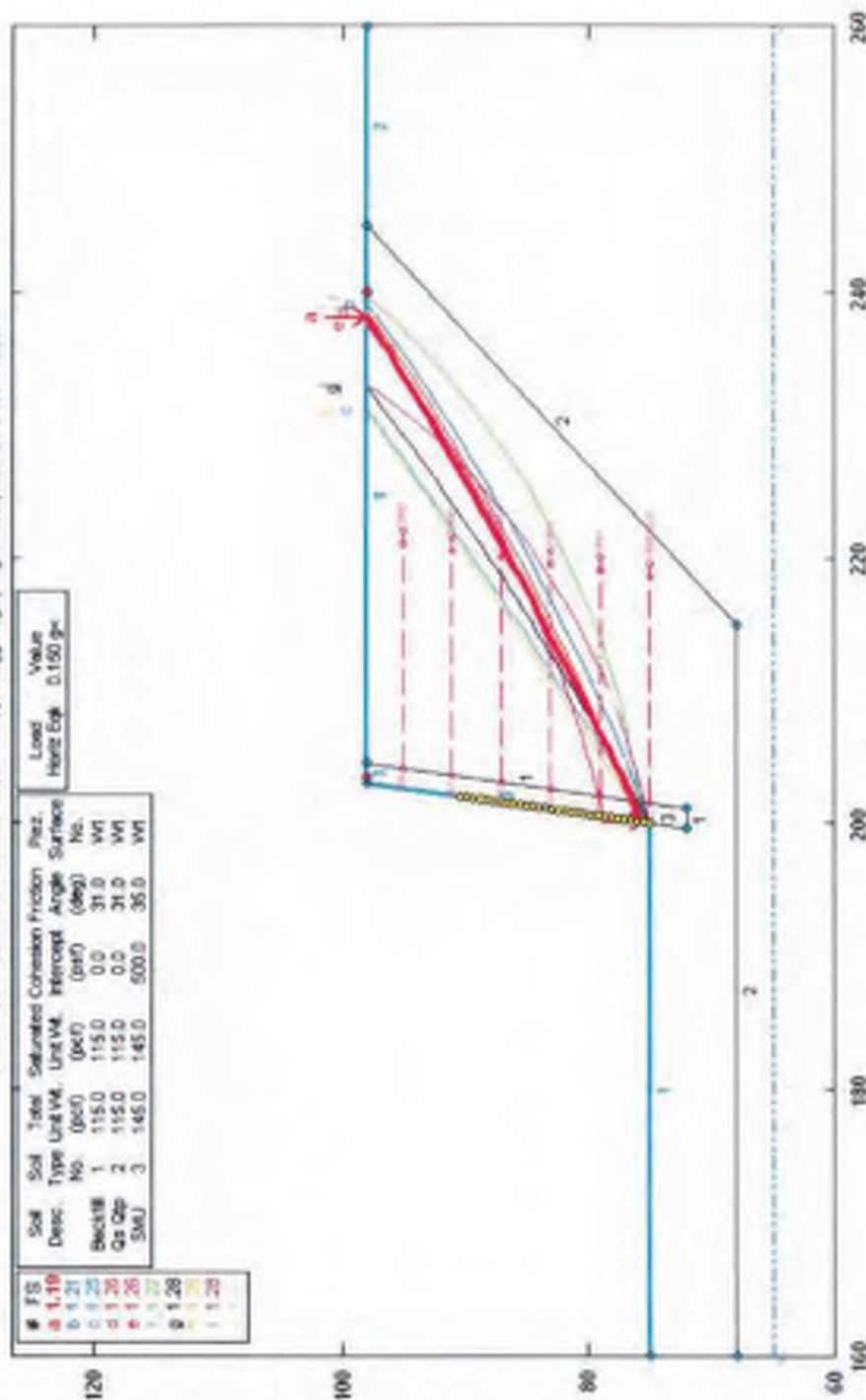

STABL6H FSmin=1.19  
 Safety Factors Are Calculated By The Modified Bishop Method

SLOPE STABILITY RESULTS: SMU RETAINING WALL, PSEUDOSTATIC CASE  
 Los Osos Wastewater Project  
 Los Osos, California



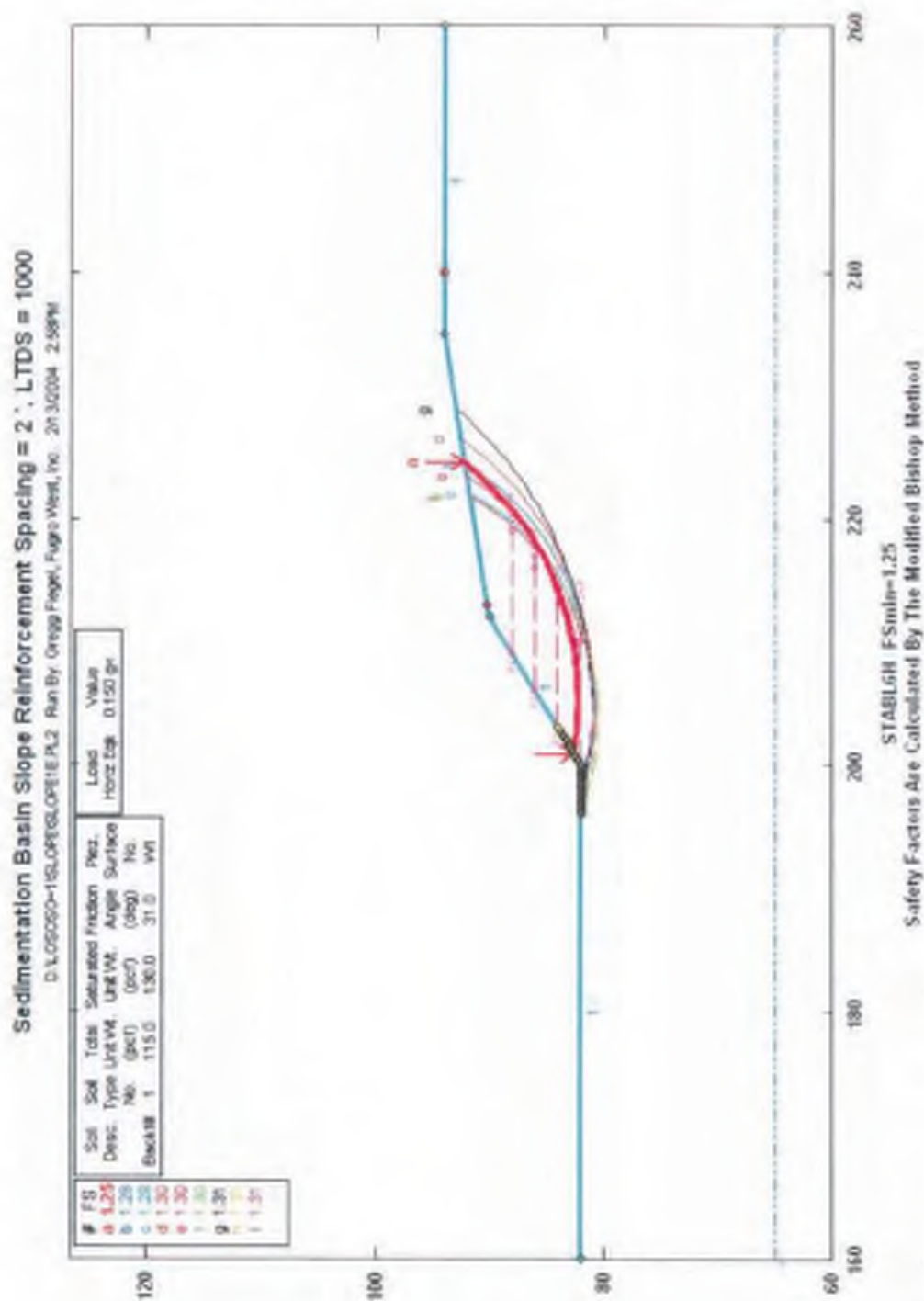

**SLOPE STABILITY RESULTS: SEDIMENTATION BASIN, PSEUDOSTATIC CASE**  
Los Osos Wastewater Project  
Los Osos, California



## APPENDIX D



PROJECT NO	3055.001	COORDINATES	N2511912 E5719107	VEHICLE	
SOUNDING	CPT-401	GROUND ELEVATION	121.8	TEST DATE	12/02/00 AM

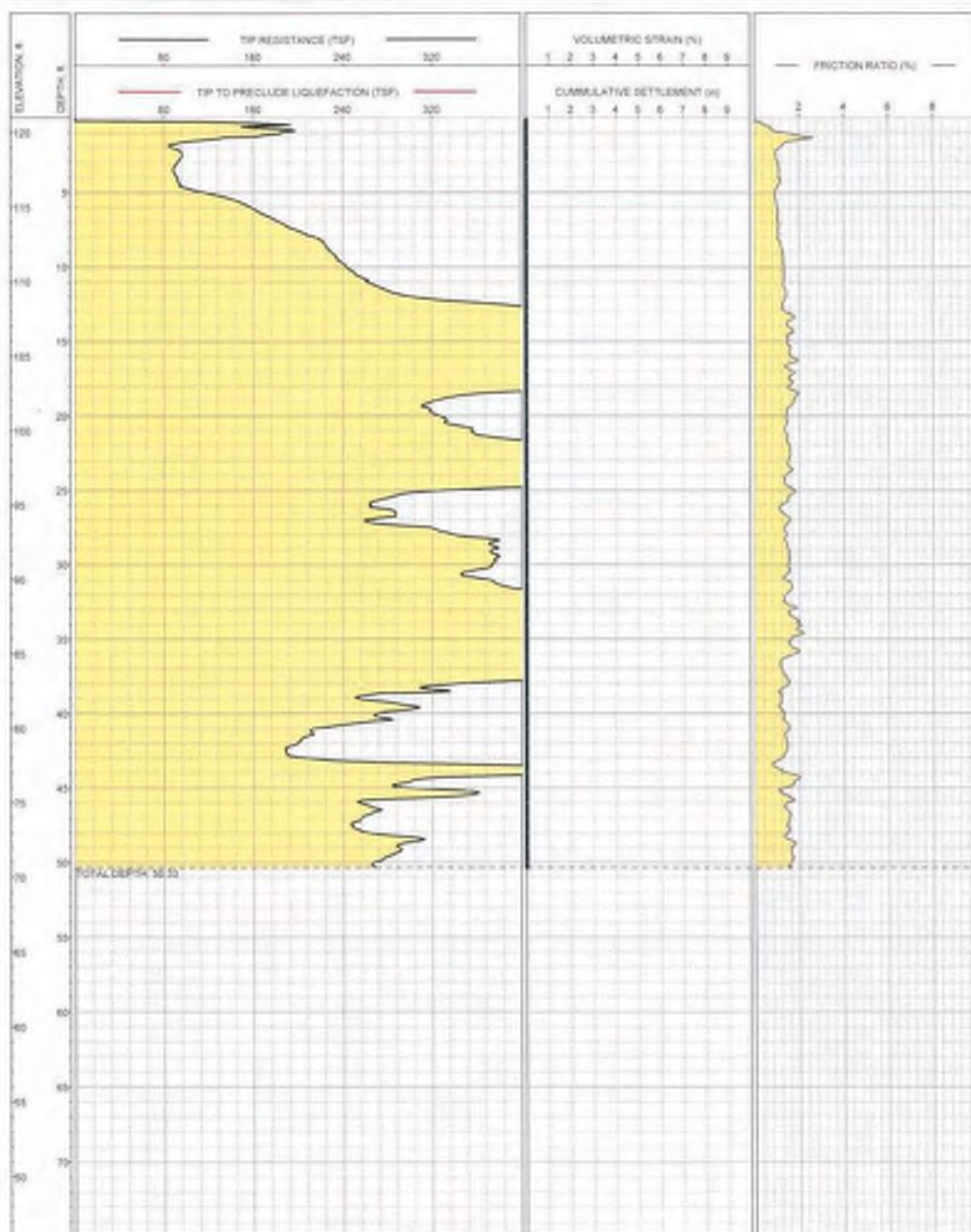

Magnitude 0.8  
 Acceleration 0.4

**LOG OF CPT**  
**SOUNDING CPT-401**  
 Los Osos Wastewater Project  
 San Luis Obispo, California



PROJECT NO	3055.001	COORDINATES	N2517802 EST18848	VEHICLE	
SOUNDING	CPT-402	GROUND ELEVATION	135.4 ft	TEST DATE	12/00/03 AM



Magnitude: 0.8  
 Acceleration: 0.4

**LOG OF CPT  
 SOUNDING CPT-402**  
 Los Osos Wastewater Project  
 San Luis Obispo, California



PROJECT NO	3055.001	COORDINATES	N2317802 E3119649	VEHICLE	
SOUNDING	CPT-403	GROUND ELEVATION	108.8.8	TEST DATE	12.00.00 AM

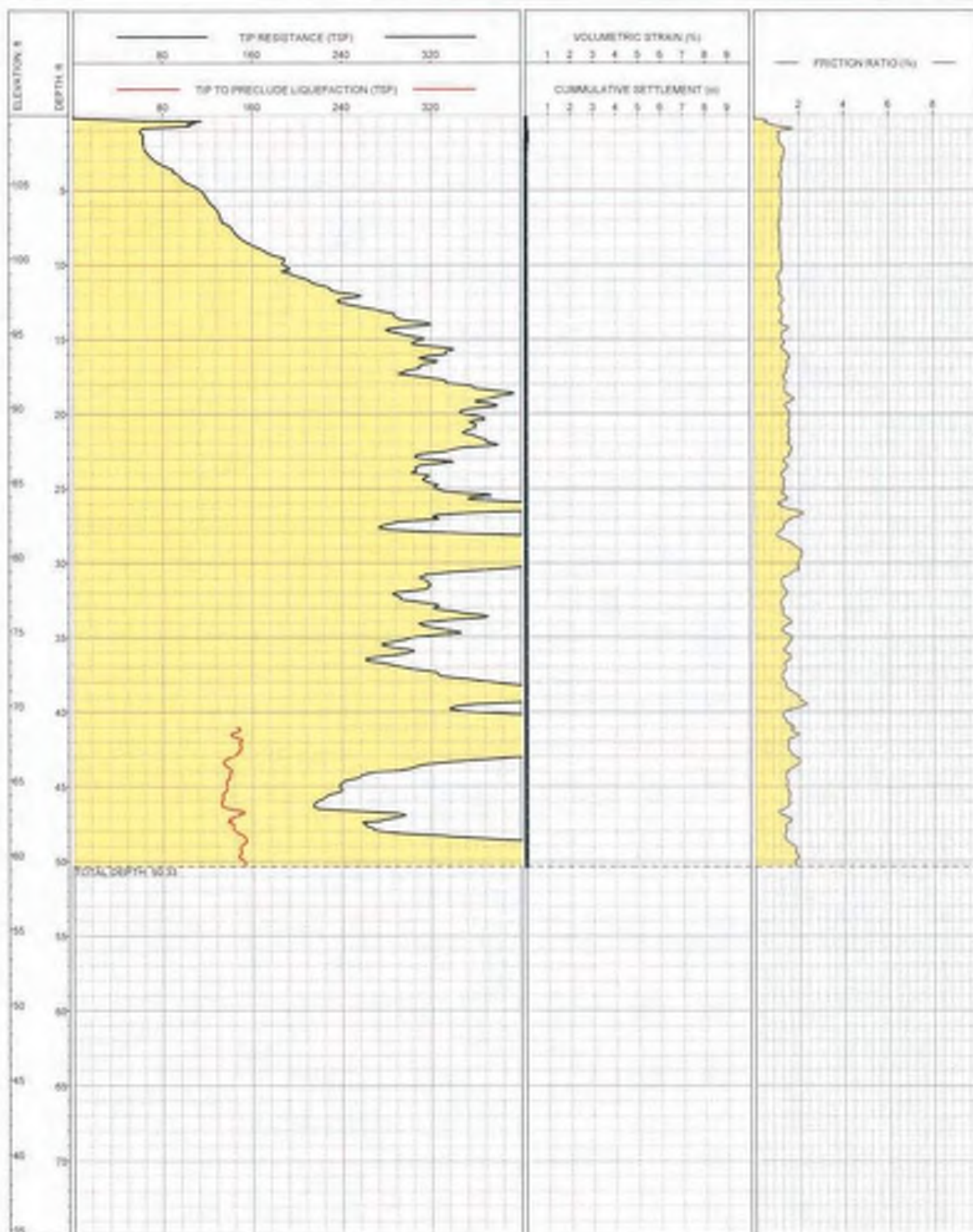

Magnitude 6.3  
 Acceleration 0.4

**LOG OF CPT**  
**SOUNDING CPT-403**  
 Los Osos Wastewater Project  
 San Luis Obispo, California



PROJECT NO	3055.001	COORDINATES	N2145118 E8711875	VEHICLE	
SOUNDING	CPT-404	GROUND ELEVATION	98.1	TEST DATE	12/00/00 AM

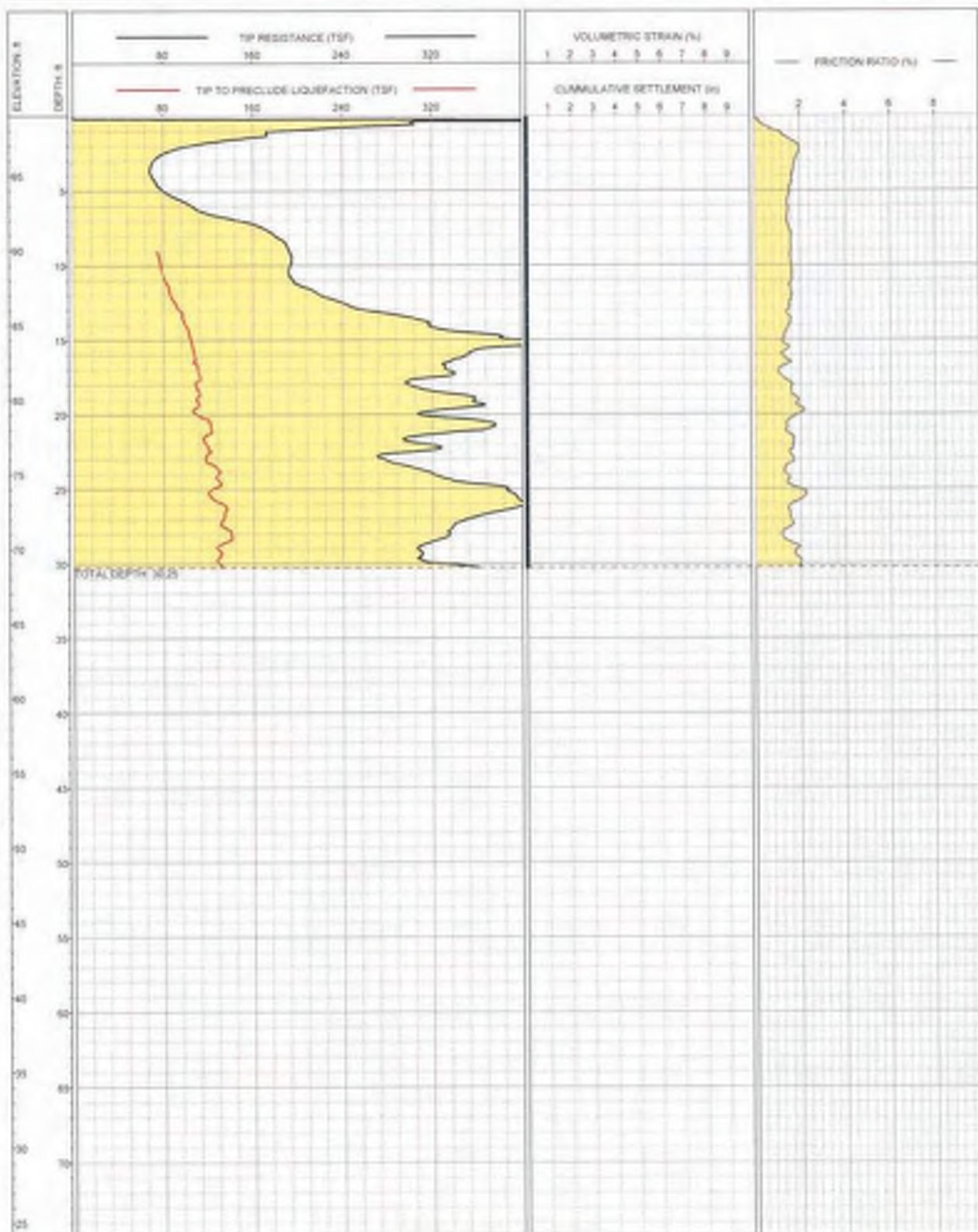

Magnitude 5.8  
 Acceleration 0.4

**LOG OF CPT**  
**SOUNDING CPT-404**  
 Los Osos Wastewater Project  
 San Luis Obispo, California



PROJECT NO	3055.001	COORDINATES	N0118612 ESTIMATED	VEHICLE	
SOUNDING	CPT-405	GROUND ELEVATION	27.81	TESTDATE	12/08/00 AM

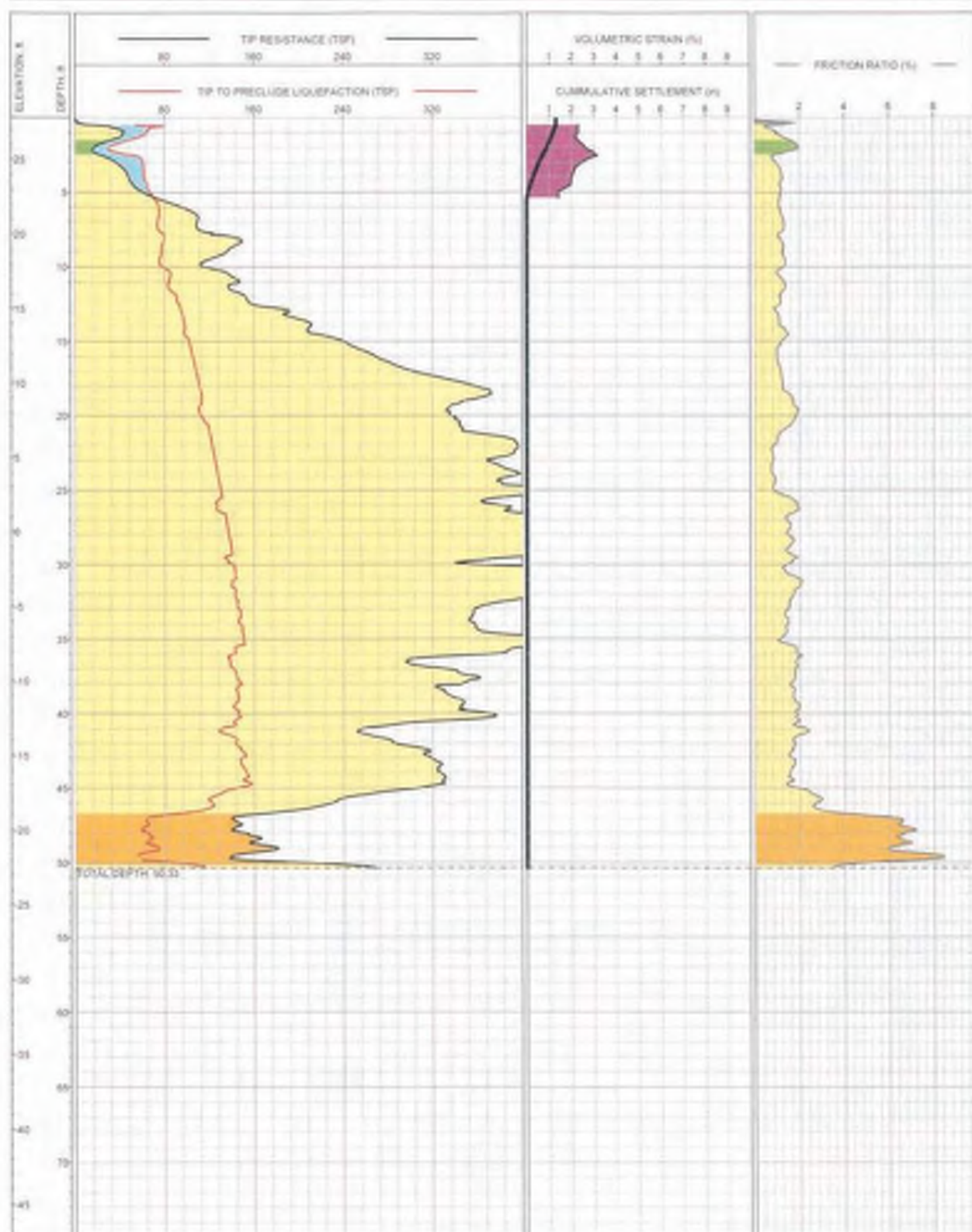

Magitude 9.9  
 Accelerator 0.4

**LOG OF CPT**  
**SOUNDING CPT-405**  
 Los Osos Wastewater Project  
 San Luis Obispo, California



PROJECT NO	3055.001	COORDINATES	N2117317 E3113957	VEHICLE	
SOUNDING	CPT-406	GROUND ELEVATION	5.8	TESTDATE	12/02/04



Magnitude 6.3  
 Acceleration 0.4

**LOG OF CPT**  
**SOUNDING CPT-406**  
 Los Osos Wastewater Project  
 San Luis Obispo, California



PROJECT NO	3055.001	COORDINATES	N2518731 E5714534	VEHICLE	
SOUNDING	CPT-407	GROUND ELEVATION	63.8	TEST DATE	12/00/00 AM

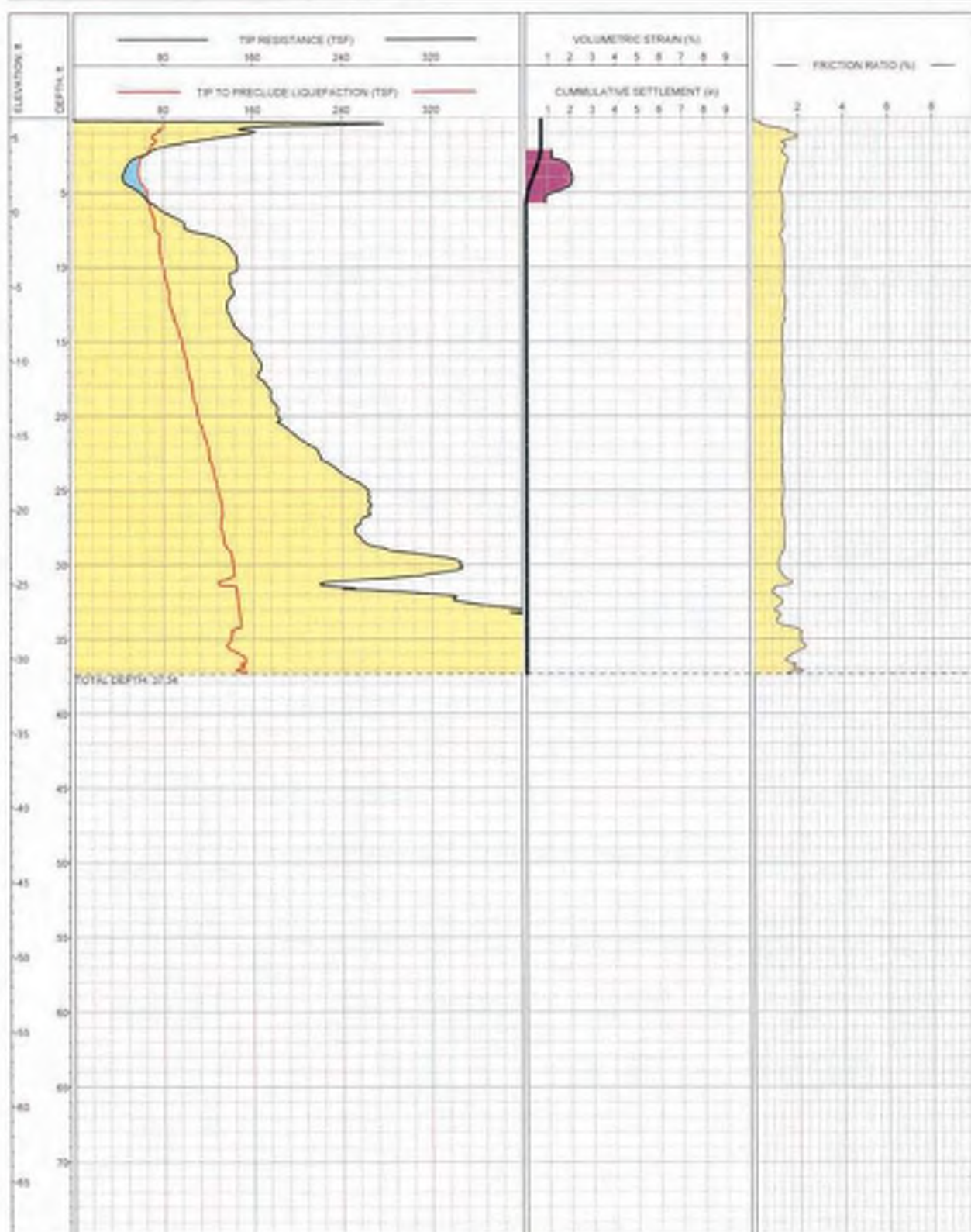

Magnitude 9.8  
 Acceleration 0.4

**LOG OF CPT**  
**SOUNDING CPT-407**  
 Los Osos Wastewater Project  
 San Luis Obispo, California



PROJECT NO	3055.001	COORDINATES	N2519604 E5716624	VEHICLE	
SOUNDING	CPT-408	GROUND ELEVATION	91.8.8	TEST DATE	12 00 00 AM



Magnitude: 0.8  
 Acceleration: 0.4

**LOG OF CPT**  
**SOUNDING CPT-408**  
 Los Osos Wastewater Project  
 San Luis Obispo, California





PROJECT NO	3055.001	COORDINATES	N218691 E571954	VEHICLE	
SOUNDING	CPT-409	GROUND ELEVATION	32.8	TEST DATE	12/02/00 AM

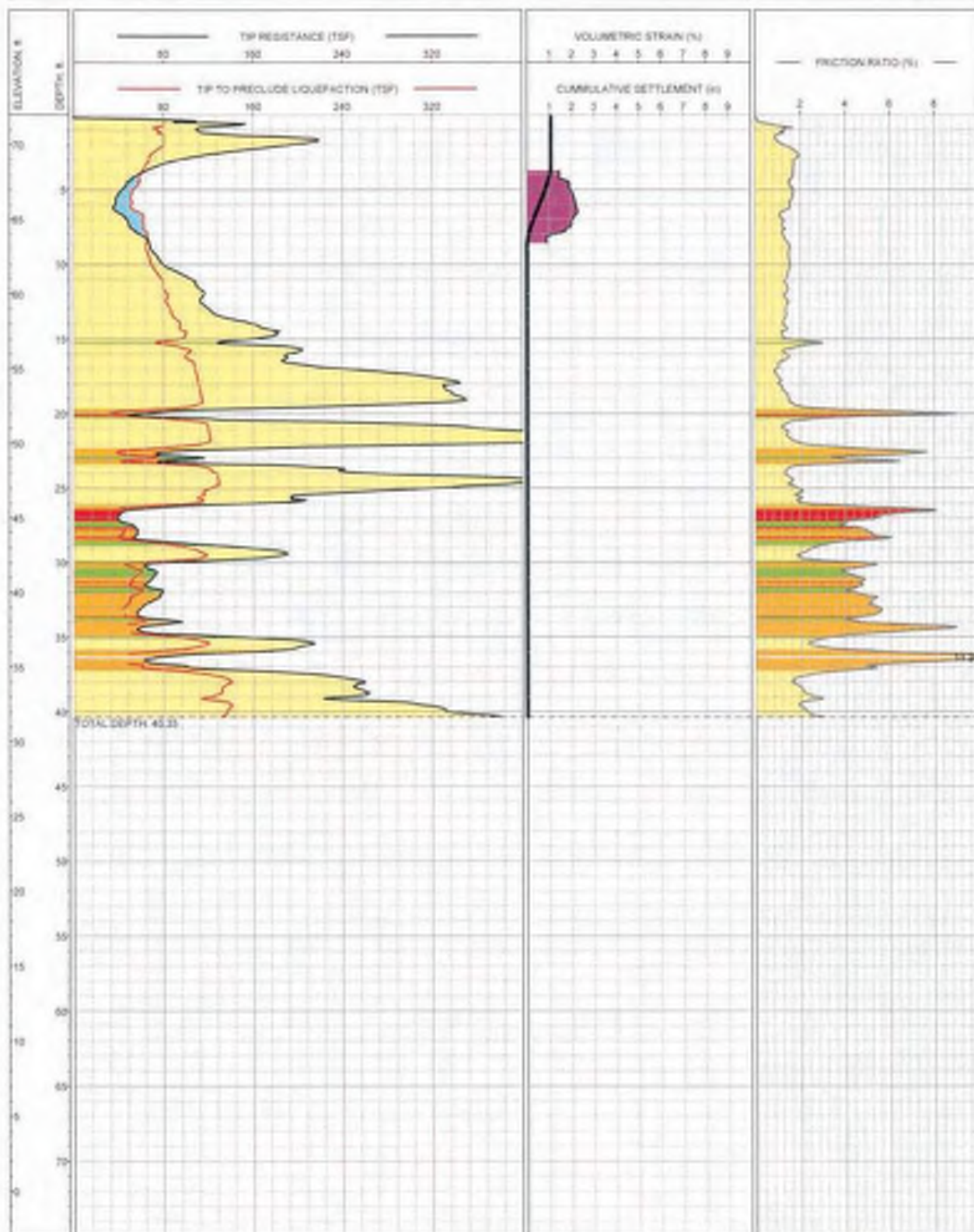

Magnitude: 6.3  
 Acceleration: 0.4

**LOG OF CPT**  
**SOUNDING CPT-409**  
 Los Osos Wastewater Project  
 San Luis Obispo, California



PROJECT NO	3055.001	COORDINATES	N2115502 E3118192	VEHICLE	
SOUNDING	CPT-410	GROUND ELEVATION	111.6 R	TESTDATE	12/20/00 AM

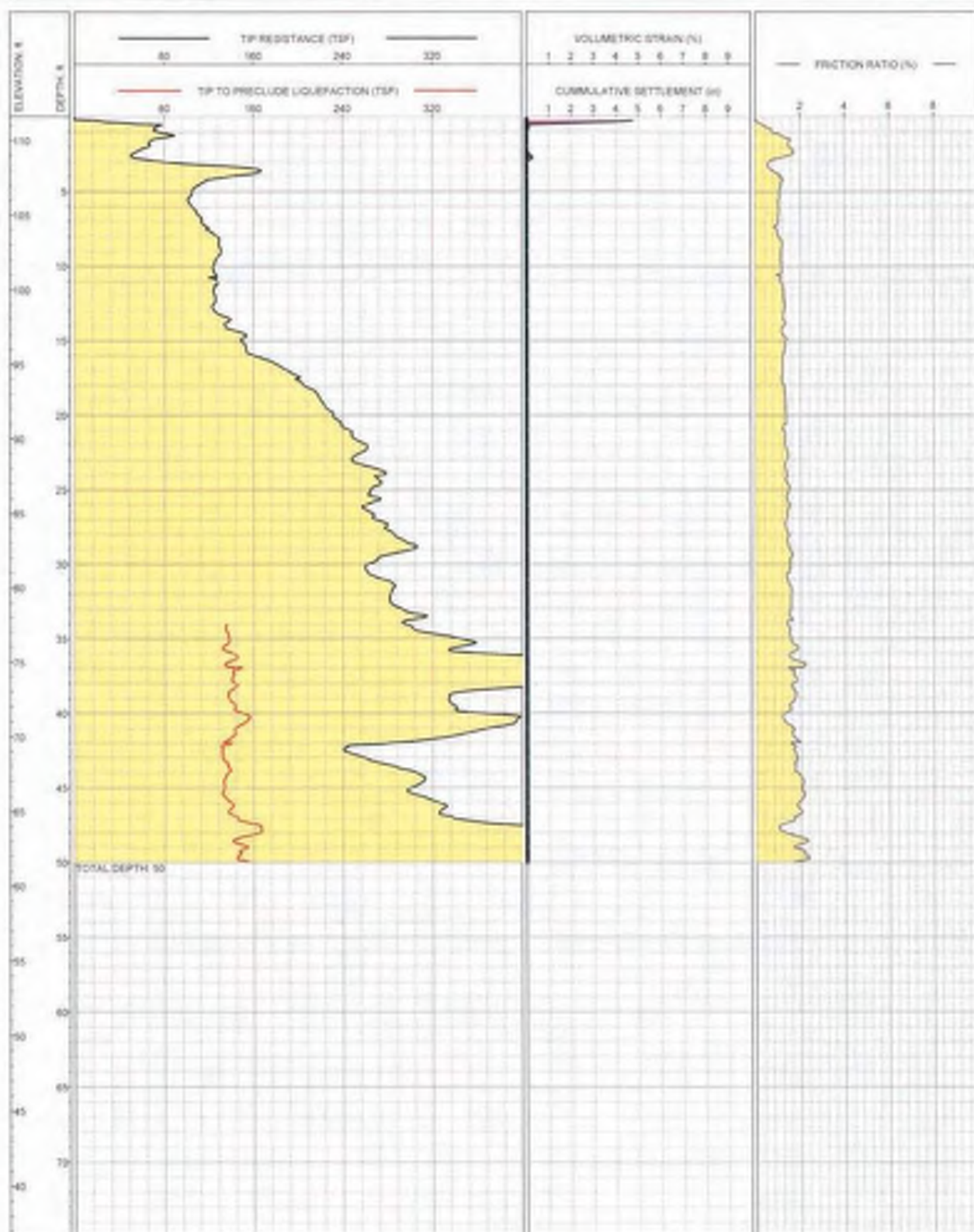

MagikLab 6.5  
 Acceleration 0.4

**LOG OF CPT**  
**SOUNDING CPT-410**  
 Los Osos Wastewater Project  
 San Luis Obispo, California



PROJECT NO	3055.001	COORDINATES	N2115104 E5716006	VEHICLE	
SOUNDING	CPT-411	GROUND ELEVATION	738.6	TEST DATE	12:00:00 AM



Magnitude 0.8  
 Acceleration 0.4

**LOG OF CPT**  
**SOUNDING CPT-411**  
 Los Osos Wastewater Project  
 San Luis Obispo, California



PROJECT NO	3055.001	COORDINATES	N25°42'02" E 11°00'00" W	VEHICLE	
SOUNDING	CPT-412	GROUND ELEVATION	86.5 ft	TEST DATE	12/00/00 AM

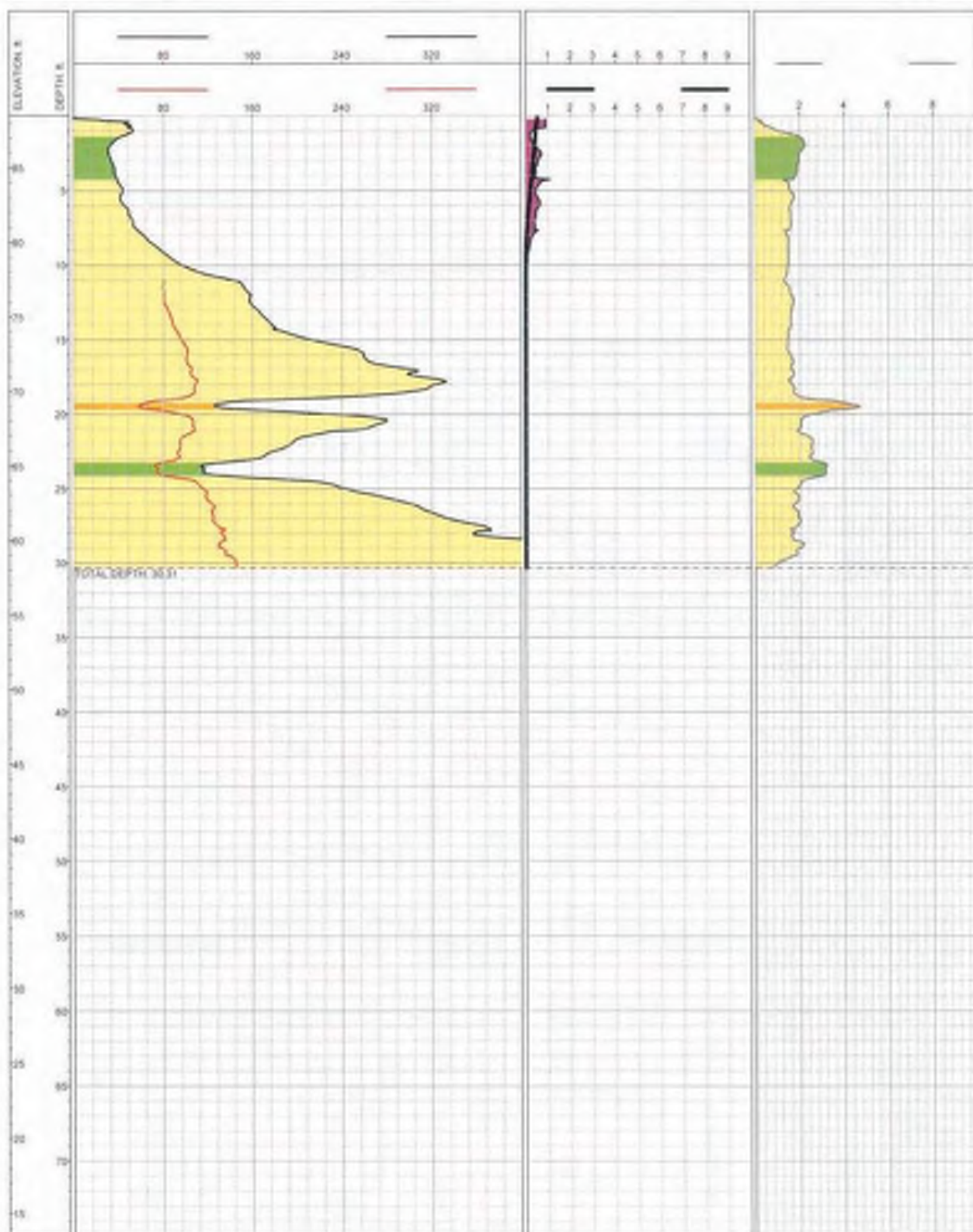

Magnitude 4.5  
 Acceleration 2.4

**LOG OF CPT**  
**SOUNDING CPT-412**  
 Los Osos Wastewater Project  
 San Luis Obispo, California



PROJECT NO	3055.001	COORDINATES	N2914632 E0710407	VEHICLE	
SOUNDING	CPT-413	GROUND ELEVATION	10.8 #	TESTDATE	12 00 00 AM

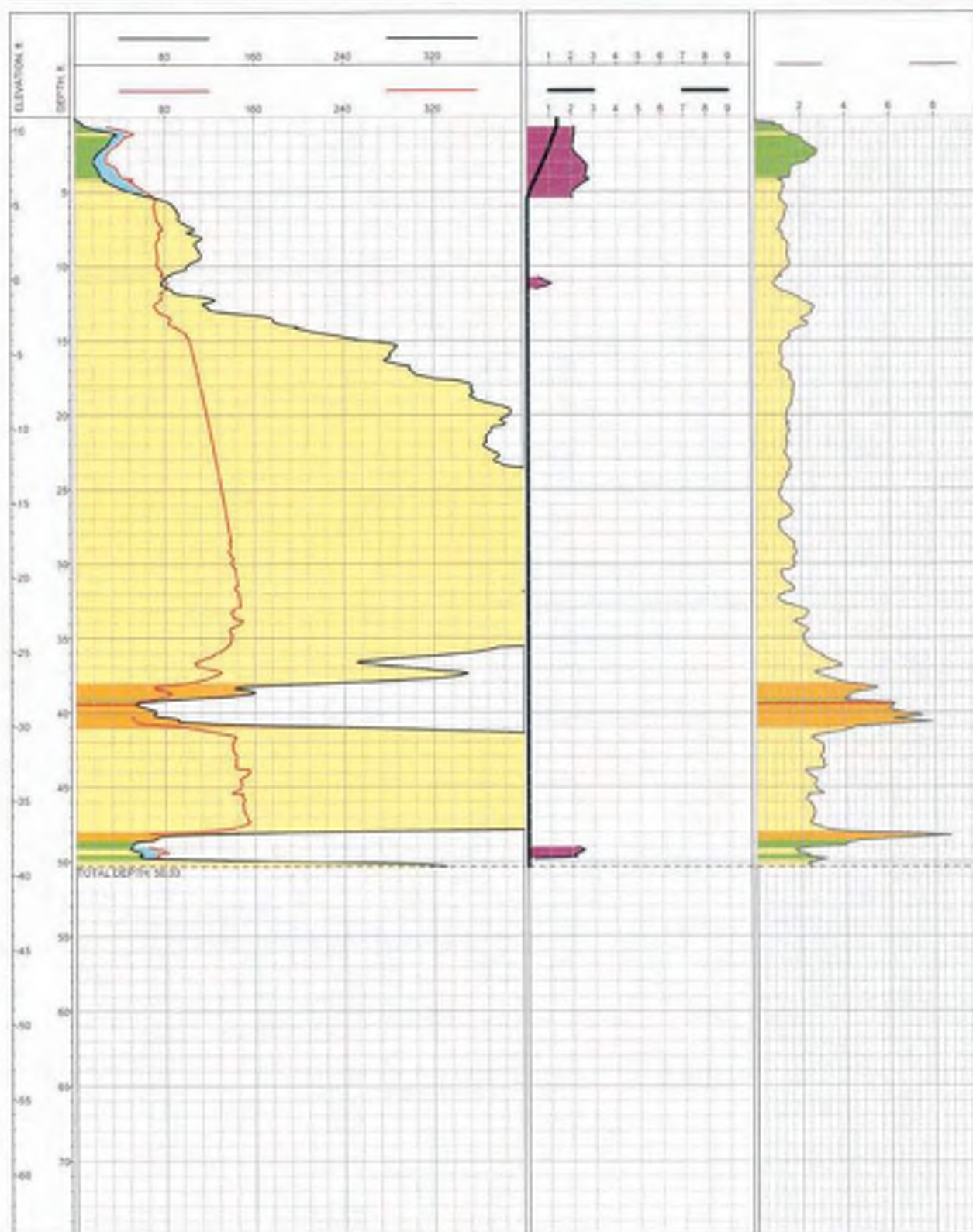

Magnitude 4.8  
 Acceleration 0.4

**LOG OF CPT**  
**SOUNDING CPT-413**  
 Los Osos Wastewater Project  
 San Luis Obispo, California



PROJECT NO. SOUNDING	3055.001 CPT-01	COORDINATES GROUND ELEVATION	N2110312 E8113104 285.7 ft	VEHICLE TEST DATE	12:00:00 AM
-------------------------	--------------------	---------------------------------	-------------------------------	----------------------	-------------

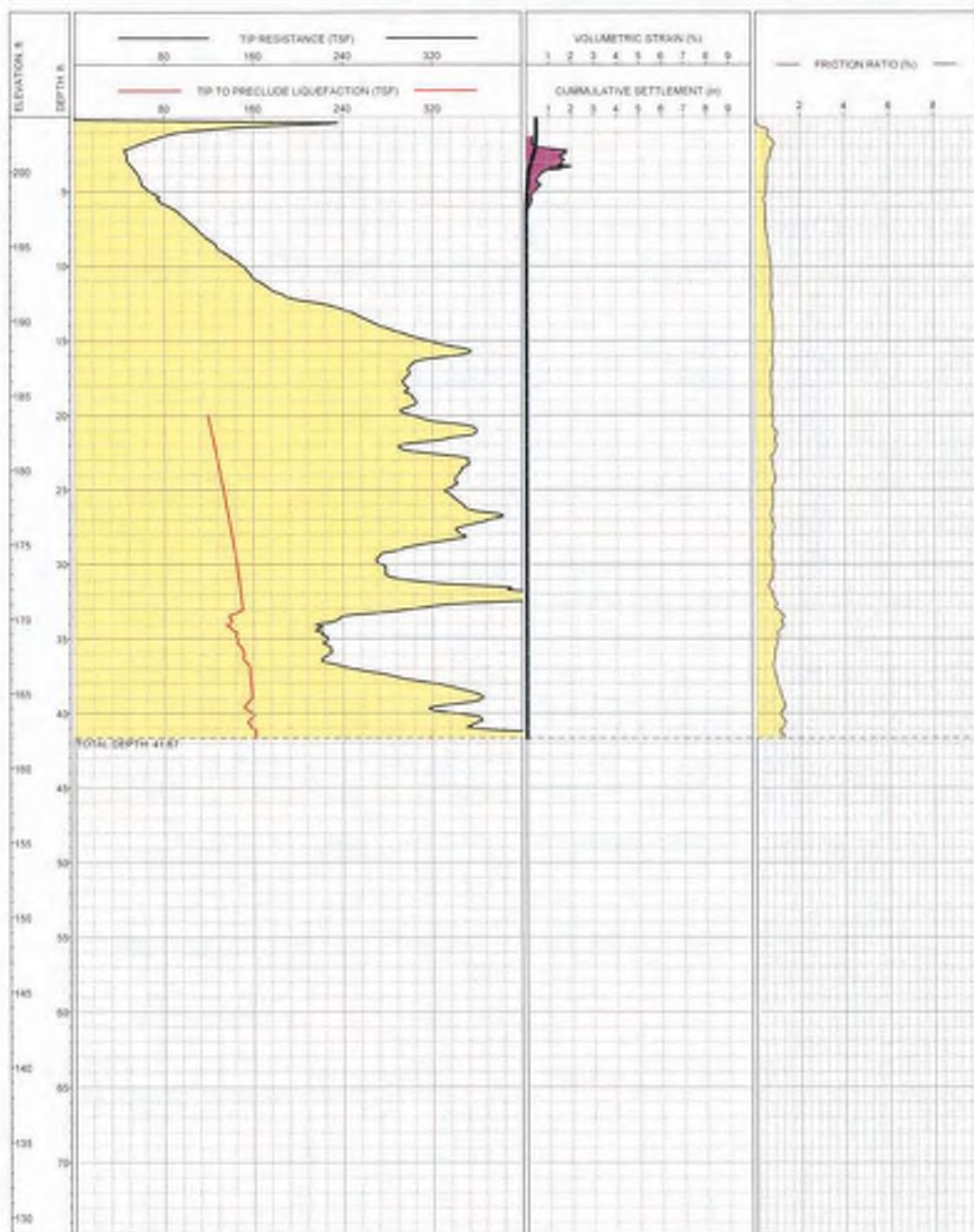

Magnitude 6.8  
 Acceleration 0.4

**LOG OF CPT  
 SOUNDING CPT-01**  
 Los Osos Wastewater Project  
 San Luis Obispo, California



PROJECT NO	3055.001	COORDINATES	N230616 E3711744	VEHICLE	
SOUNDING	CPT-02	GROUND ELEVATION	274.39	TEST DATE	12/02/00 AM



Magnitude 4.8  
 Acceleration 0.4

**LOG OF CPT**  
**SOUNDING CPT-02**  
 Los Osos Wastewater Project  
 San Luis Obispo, California



PROJECT NO	3055.001	COORDINATES	N230W91 E3712969	VEHICLE	
SOUNDING	CPT-03	GROUND ELEVATION	238.3 ft	TEST DATE	12/02/03 AM



Magnitude: 0.8  
 Acceleration: 0.4

**LOG OF CPT**  
**SOUNDING CPT-03**  
 Los Osos Wastewater Project  
 San Luis Obispo, California





PROJECT NO	3055.001	COORDINATES	N217004 E370243	VEHICLE	
SOUNDING	CPT-04	GROUND ELEVATION	227.88	TESTDATE	12:00:00 AM

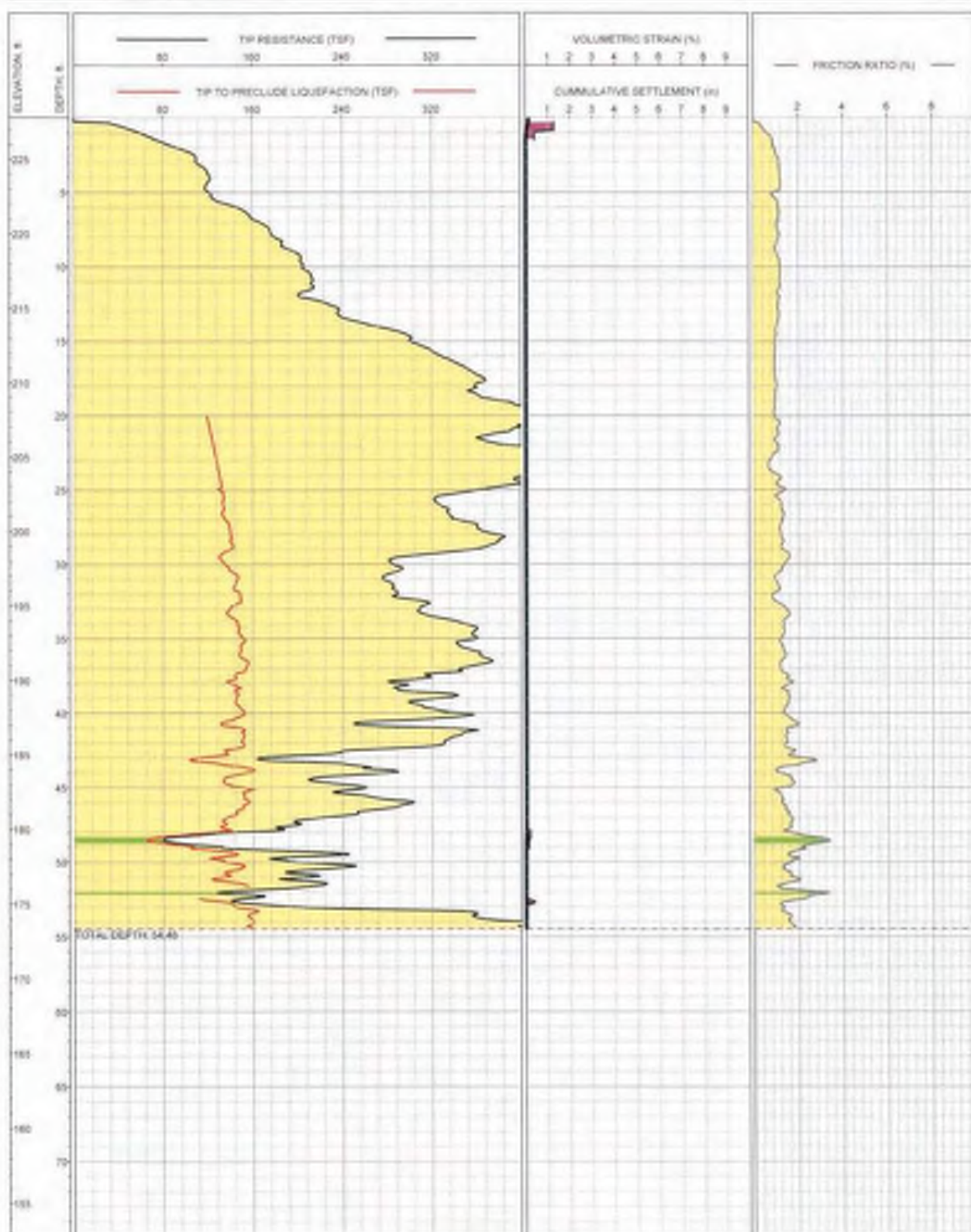

Magnitude: 0.8  
 Acceleration: 0.4

**LOG OF CPT**  
**SOUNDING CPT-04**  
 Los Osos Wastewater Project  
 San Luis Obispo, California



PROJECT NO. SOUNDING	3055-001 CPT-05	COORDINATES GROUND ELEVATION	N2010434 E8111882 185.1	VEHICLE TEST DATE	12:00:00 AM
-------------------------	--------------------	---------------------------------	----------------------------	----------------------	-------------

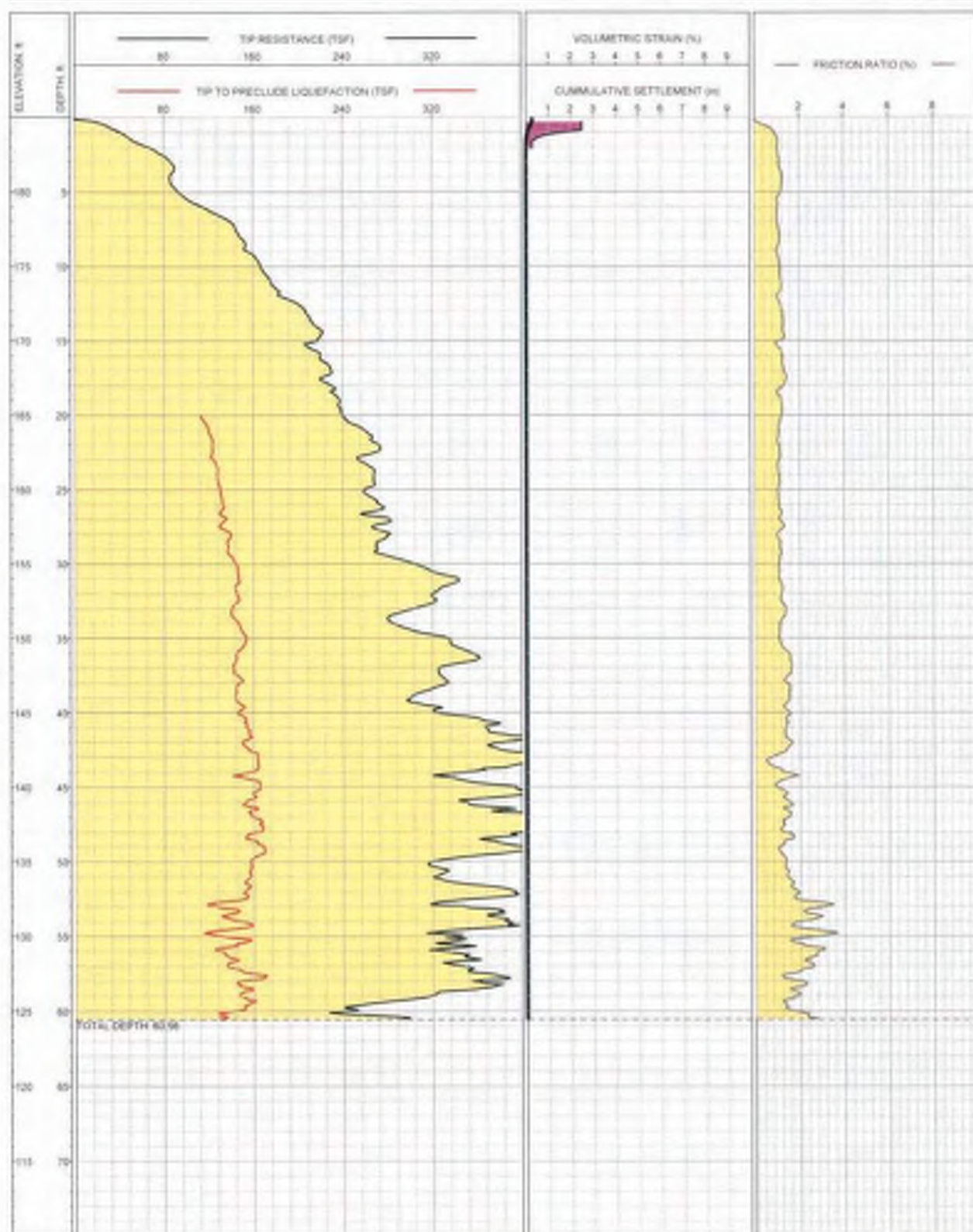

Magnitude: 0.8  
 Acceleration: 0.4

**LOG OF CPT**  
**SOUNDING CPT-05**  
 Los Osos Wastewater Project  
 San Luis Obispo, California



PROJECT NO. SOUNDING	3055.001 CPT-06	COORDINATES GROUND ELEVATION	N230960 E8112106 275.8.8	VEHICLE TEST DATE	12:00:00 AM
-------------------------	--------------------	---------------------------------	-----------------------------	----------------------	-------------



Magnitude: 6.3  
 Acceleration: 2.4

**LOG OF CPT**  
**SOUNDING CPT-06**  
 Los Osos Wastewater Project  
 San Luis Obispo, California



PROJECT NO	3055.001	COORDINATES	N2304142 E3712014	VEHICLE	
SOUNDING	CPT-07	GROUND ELEVATION	268.9 ft	TEST DATE	12:00:00 AM

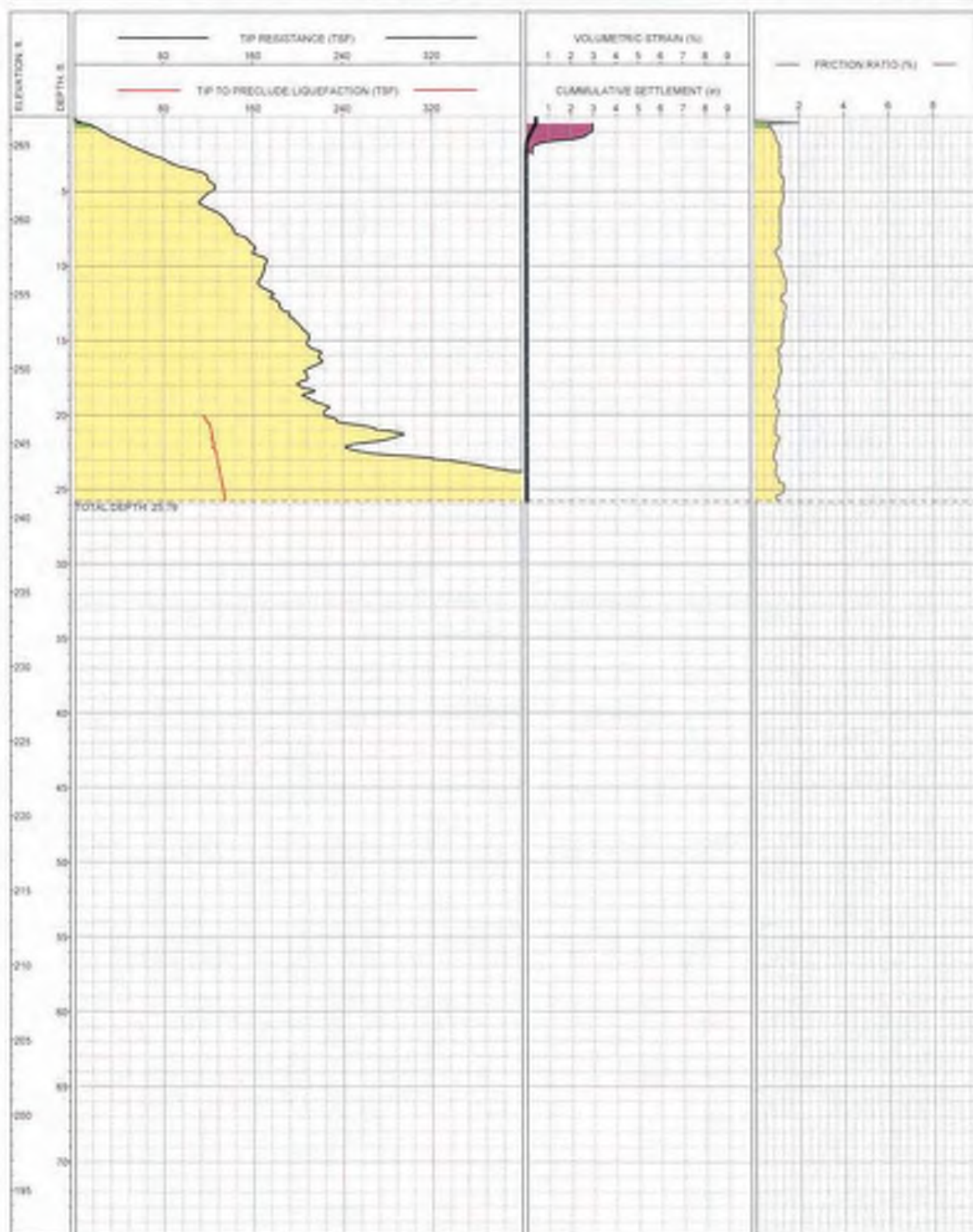

Magnitude: 0.3  
 Acceleration: 0.4

**LOG OF CPT**  
**SOUNDING CPT-07**  
 Los Osos Wastewater Project  
 San Luis Obispo, California



PROJECT NO	3055.001	COORDINATES	N211642 E371266	VEHICLE	
SOUNDING	CPT-08	GROUND ELEVATION	191.18	TEST DATE	12.00.00 AM

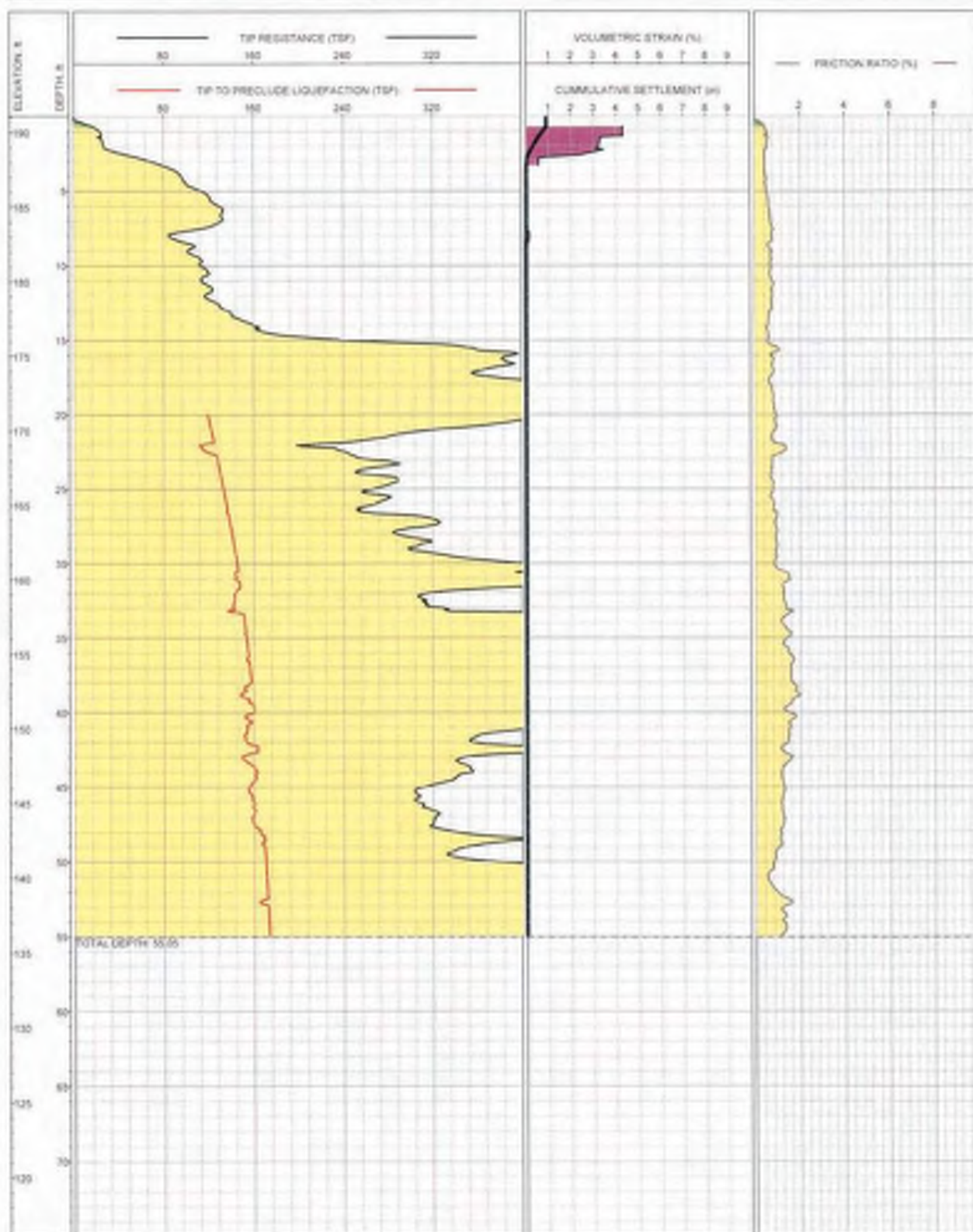

Magnitude 3.3  
 Acceleration 0.4

**LOG OF CPT**  
**SOUNDING CPT-08**  
 Los Osos Wastewater Project  
 San Luis Obispo, California



PROJECT NO	3055-001	COORDINATES	N271341 E3711562	VEHICLE	
SOUNDING	CPT-09	GROUND ELEVATION	43.18	TEST DATE	12-08-03 AM

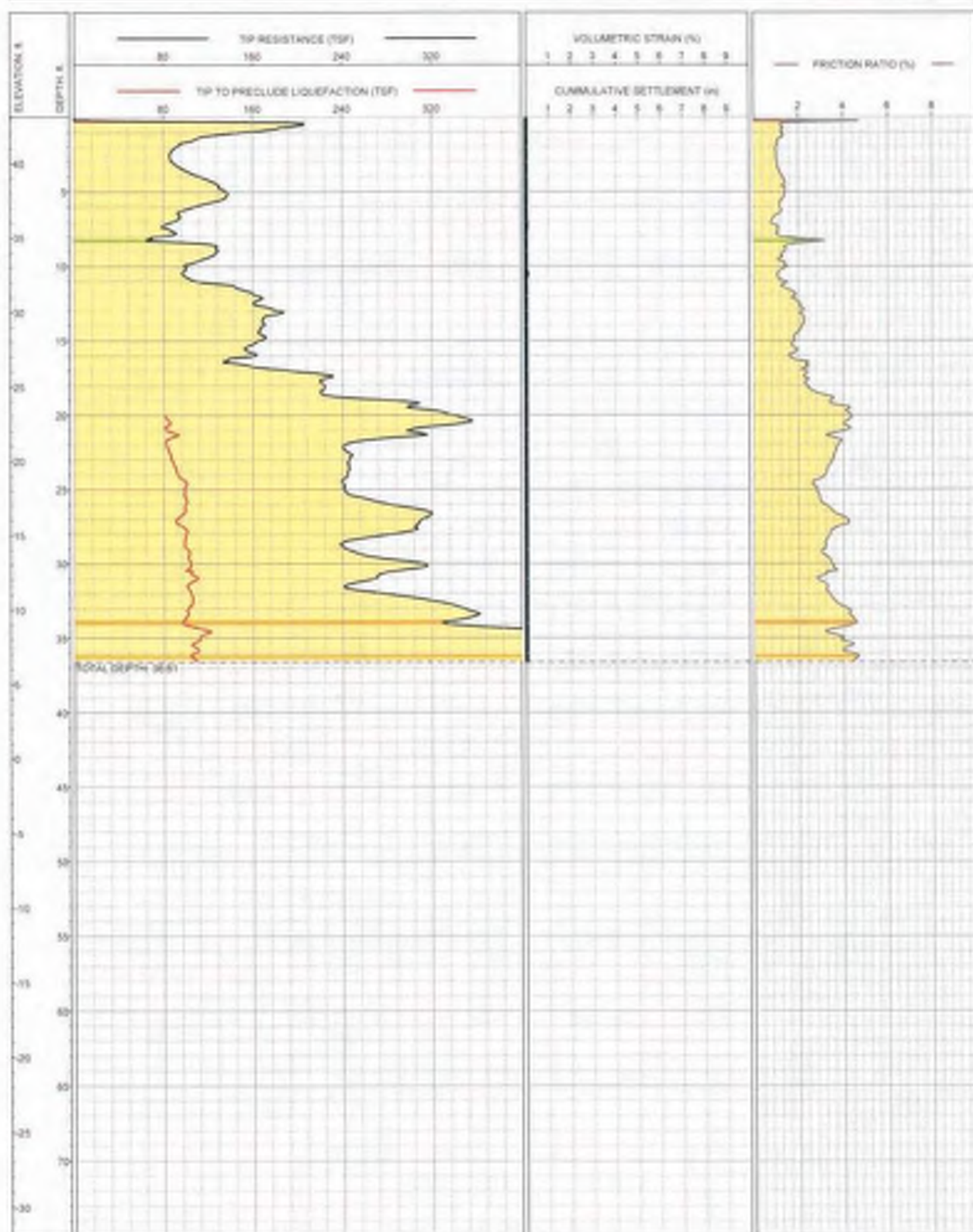

Magnitude 6.8  
 Acceleration 0.4

**LOG OF CPT**  
**SOUNDING CPT-09**  
 Los Osos Wastewater Project  
 San Luis Obispo, California



PROJECT NO	3055.001	COORDINATES	N2310720 E5711154	VEHICLE	
SOUNDING	CPT-10	GROUND ELEVATION	156.8	TEST DATE	12/02/03 AM

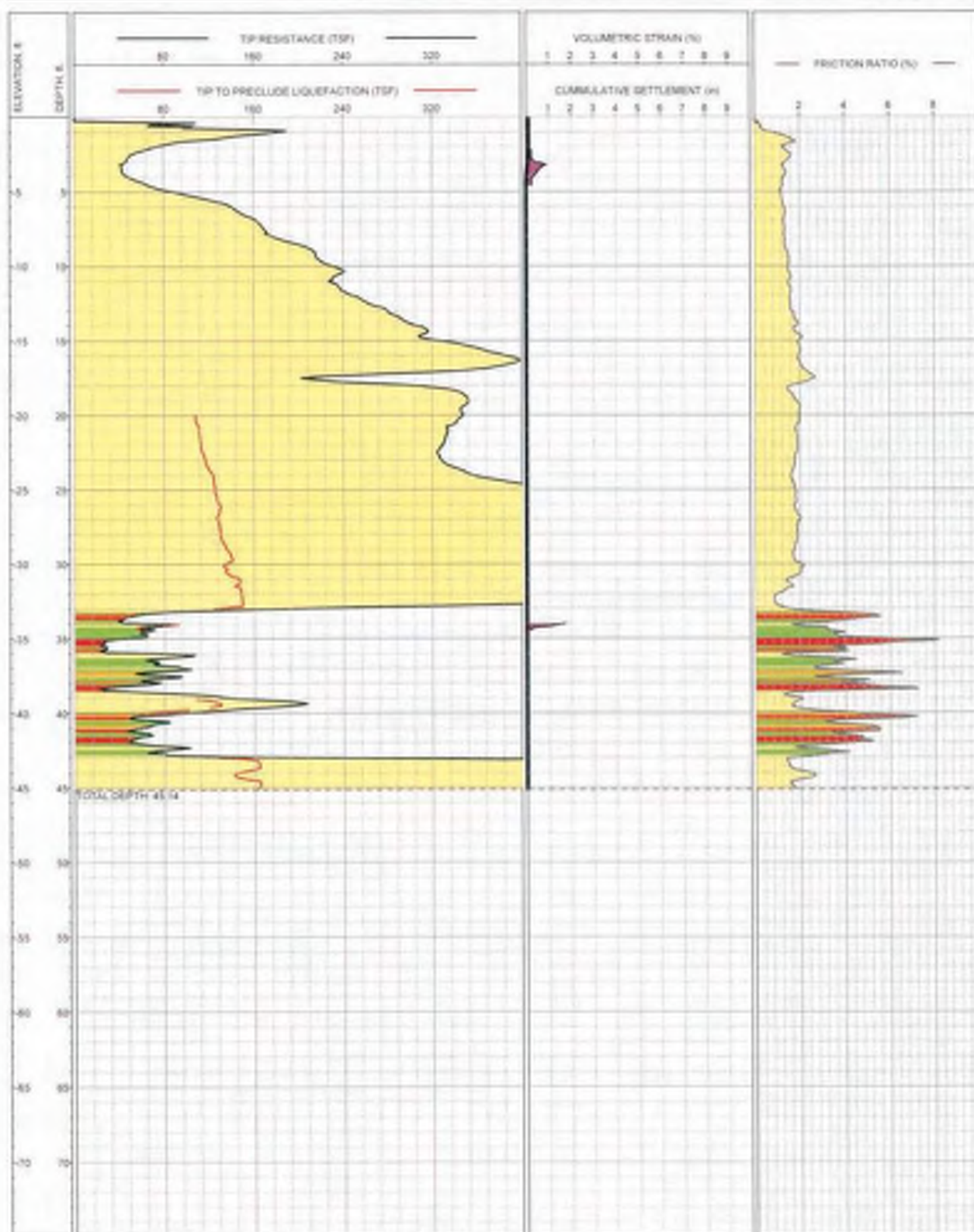

Magnitude 4.8  
 Acceleration 2.4

**LOG OF CPT**  
**SOUNDING CPT-10**  
 Los Osos Wastewater Project  
 San Luis Obispo, California



PROJECT NO	3055.001	COORDINATES	N2510631 E3714670	VEHICLE	
SOUNDING	CPT-11	GROUND ELEVATION	175.4.9	TEST DATE	12.00.00 AM

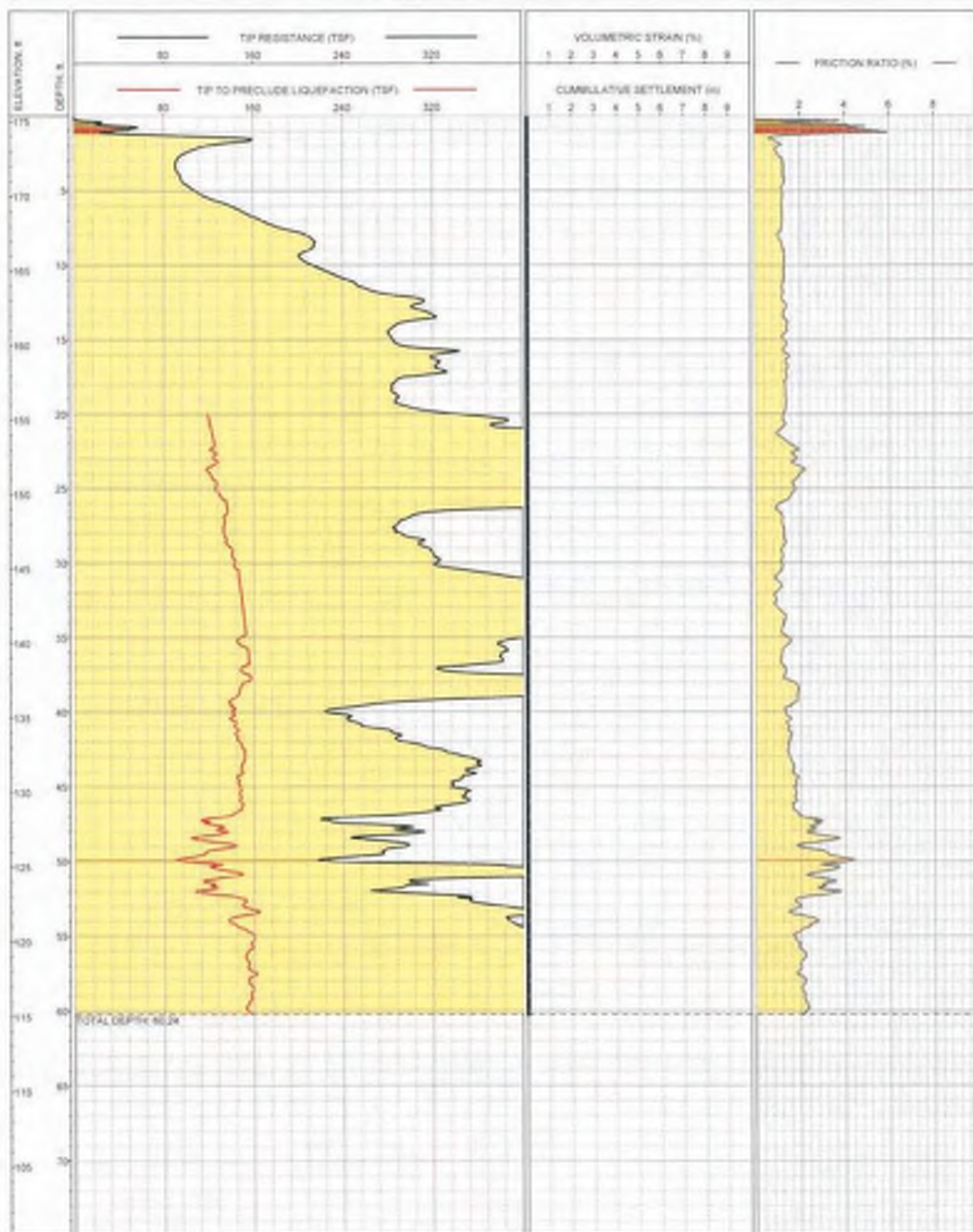

Magnitude: 8.8  
 Acceleration: 0.4

**LOG OF CPT**  
**SOUNDING CPT-11**  
 Los Osos Wastewater Project  
 San Luis Obispo, California





PROJECT NO	3055.001	COORDINATES	N2372239 E37111964	VEHICLE	
SOUNDING	CPT-13	GROUND ELEVATION	828.8	TEST DATE	12:00:00 AM

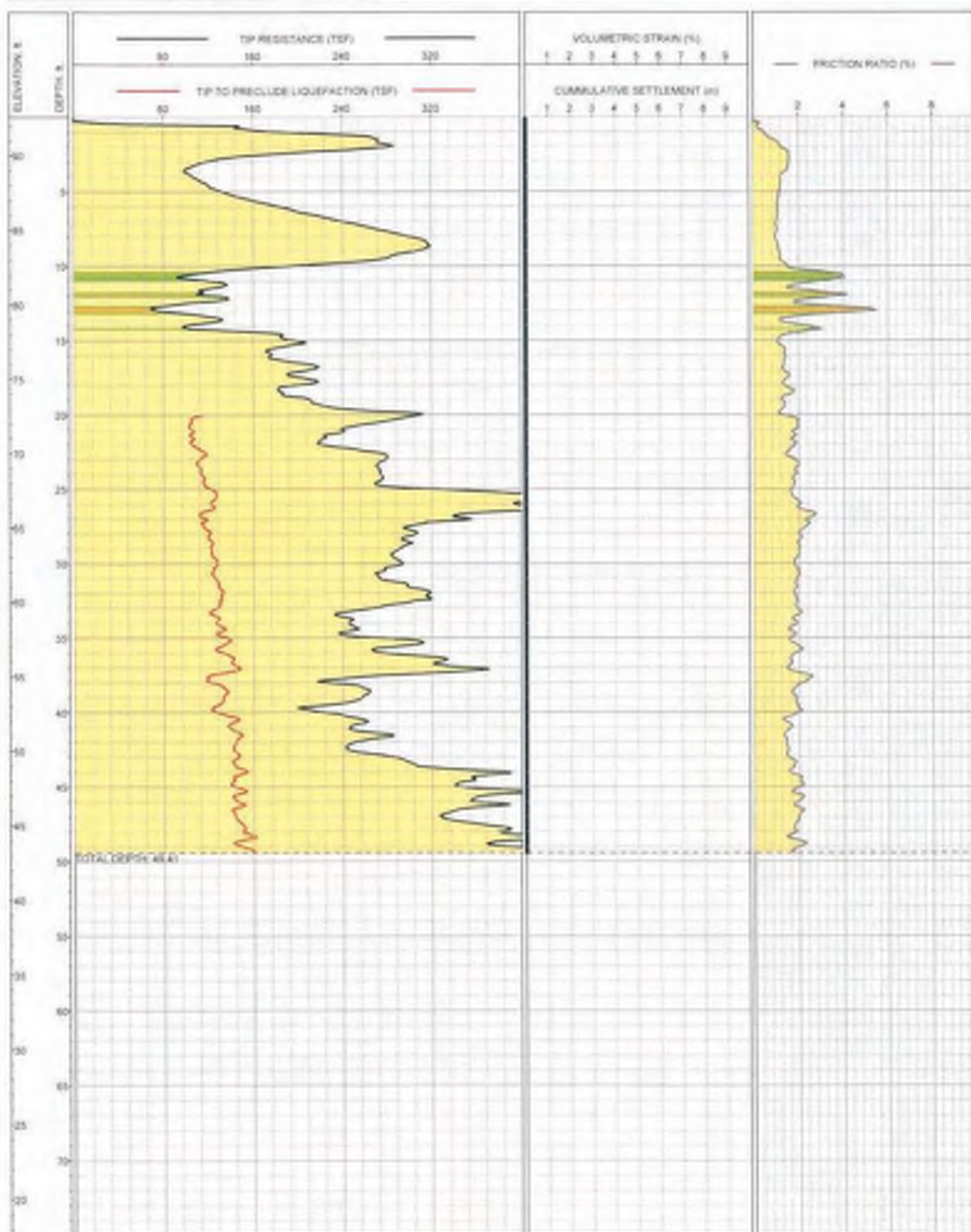

Magnitude 3.8  
 Acceleration 0.4

**LOG OF CPT  
 SOUNDING CPT-13**  
 Los Osos Wastewater Project  
 San Luis Obispo, California



PROJECT NO	3055.001	COORDINATES	N2913573 E3719608	VEHICLE	
SOUNDING	CPT-14	GROUND ELEVATION	538.8	TEST DATE	12/02/03 AM

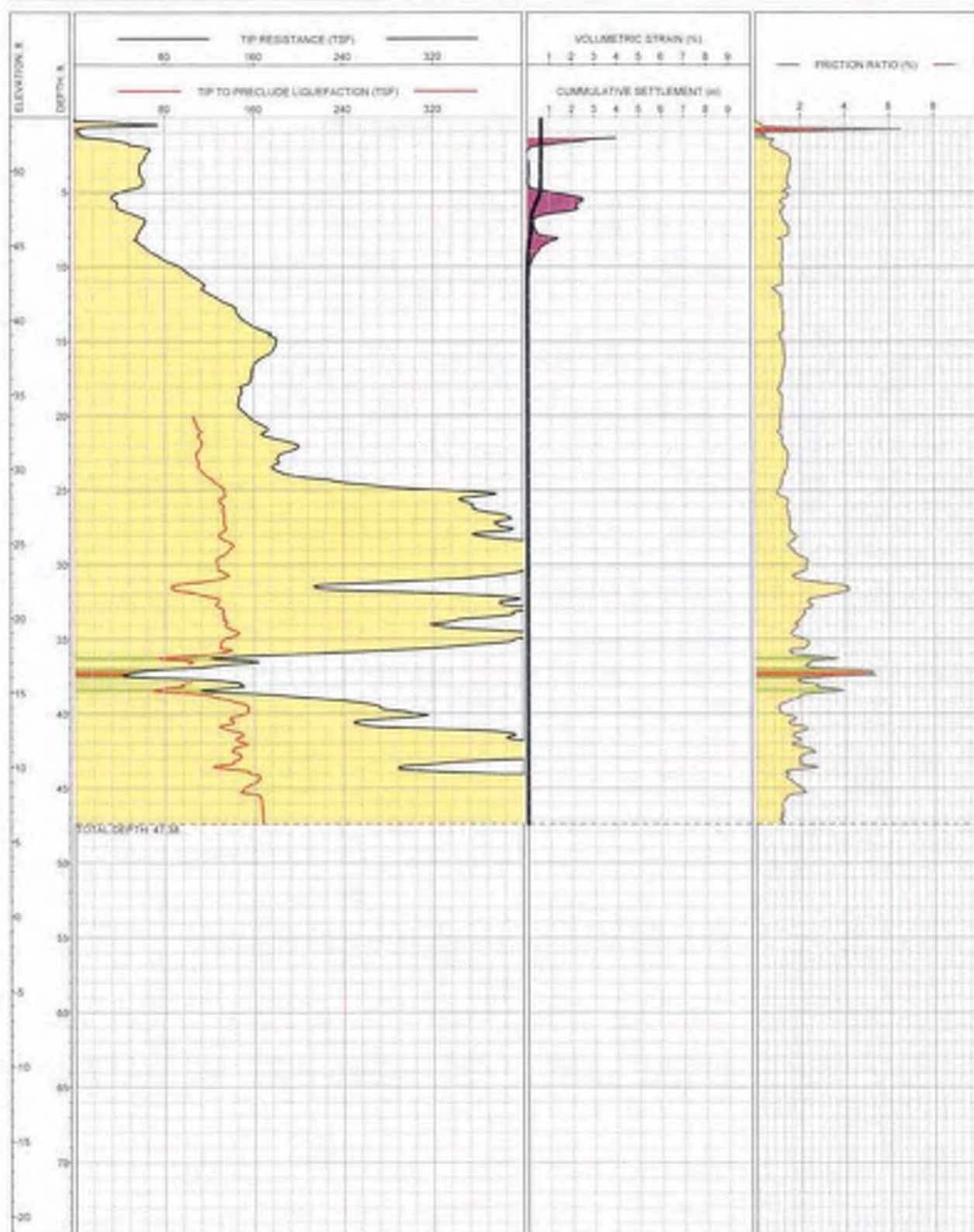

Magnitude: 8.3  
 Acceleration: 0.4

**LOG OF CPT**  
**SOUNDING CPT-14**  
 Los Osos Wastewater Project  
 San Luis Obispo, California



PROJECT NO	3055.001	COORDINATES	N2112P18 E5171864	VEHICLE	
SOUNDING	CPT-15	GROUND ELEVATION	28.98'	TEST DATE	12.00.00 AM

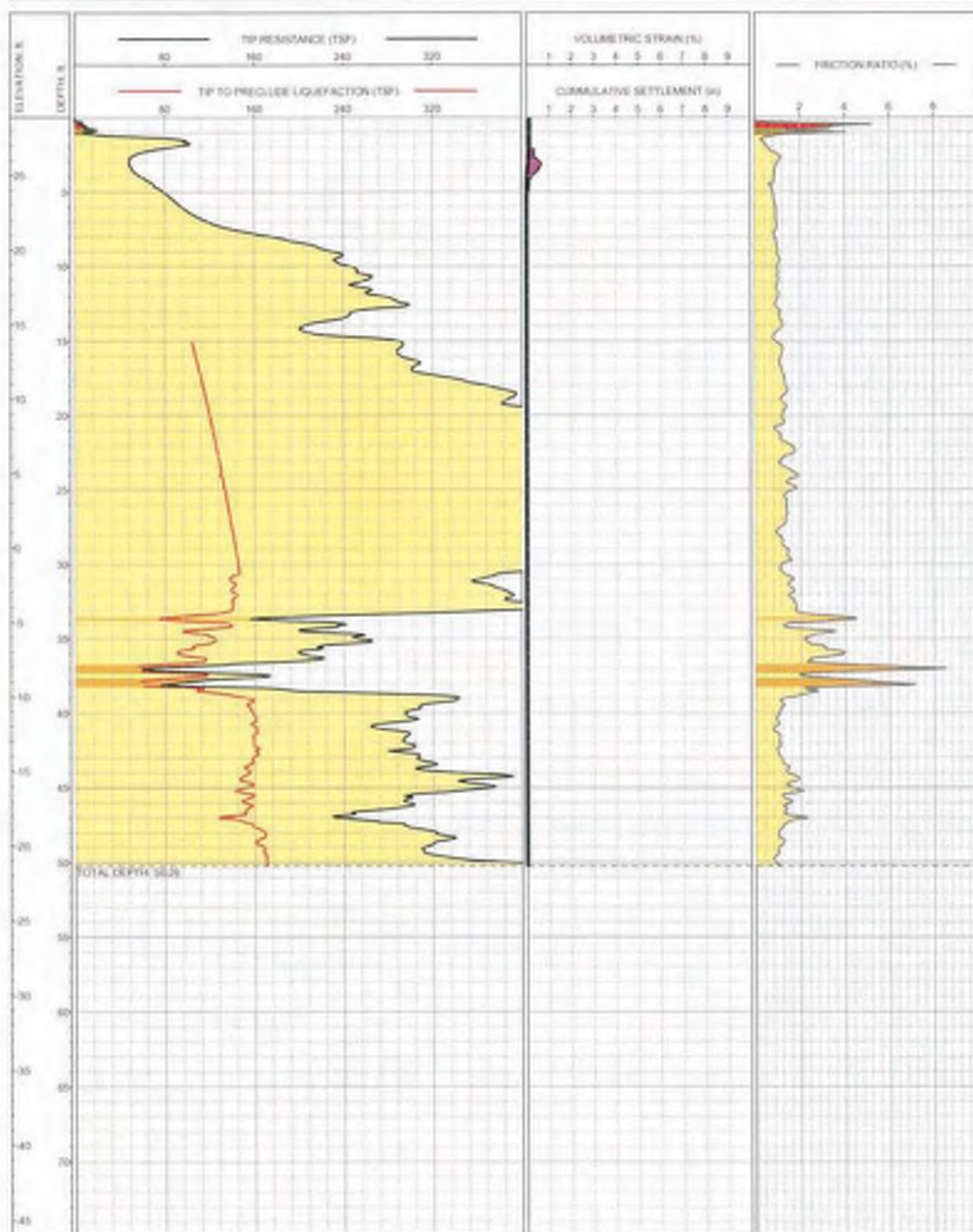

Magnitude: 1.0  
 Acceleration: 0.1

**LOG OF CPT**  
**SOUNDING CPT-15**  
 Los Osos Wastewater Project  
 San Luis Obispo, California



PROJECT NO.	3055.001	COORDINATES	N2514291 E0712264	VEHICLE	
SOUNDING	CPT-16	GROUND ELEVATION	12.2 ft	TEST DATE	12.00.00 AM

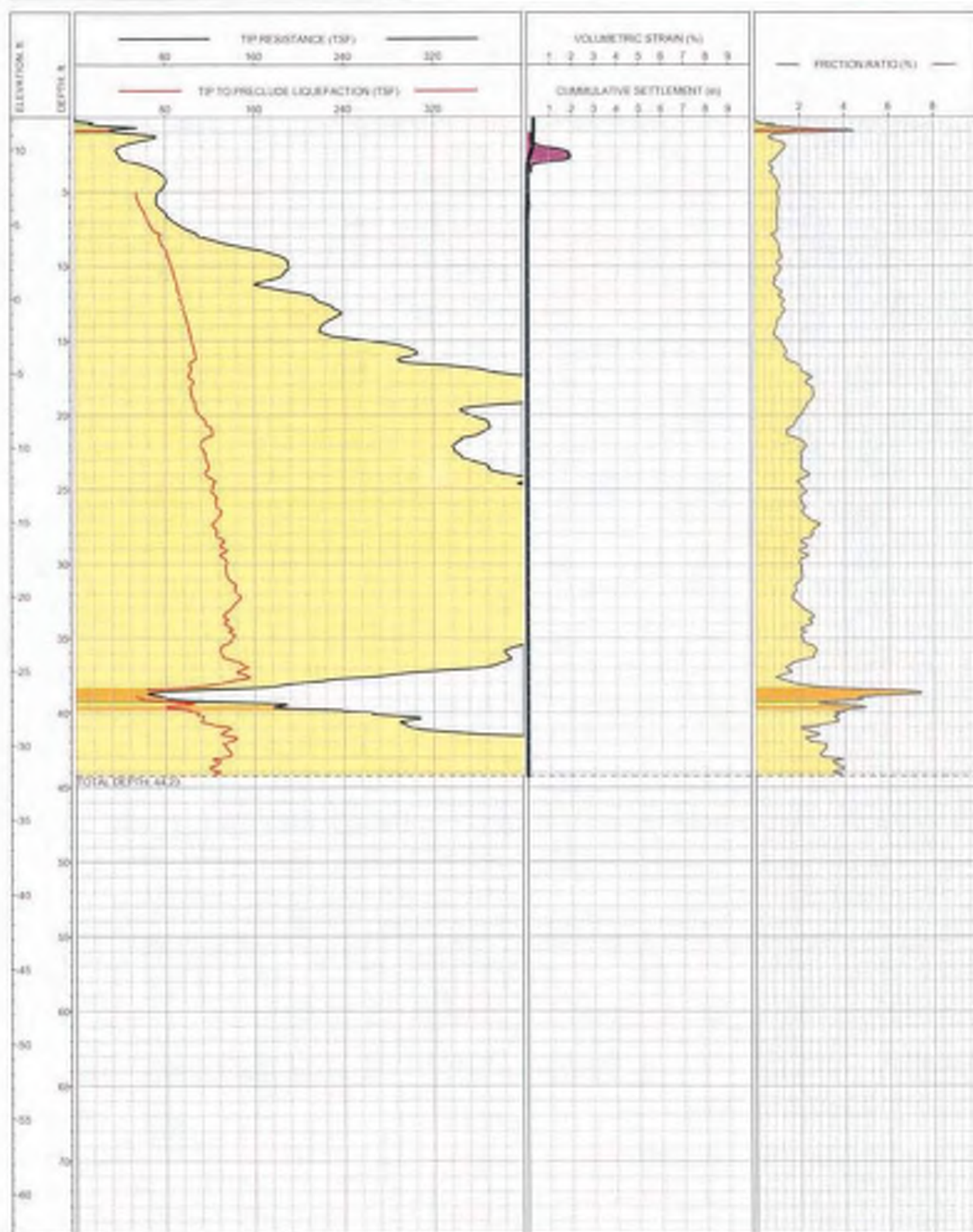

Magnitude 0.3  
 Acceleration 0.4

**LOG OF CPT**  
**SOUNDING CPT-16**  
 Los Osos Wastewater Project  
 San Luis Obispo, California



PROJECT NO	3055-001	COORDINATES	N231146 E371962	VEHICLE	
SOUNDING	CP1-17	GROUND ELEVATION	01	TEST DATE	12/01/00 AM

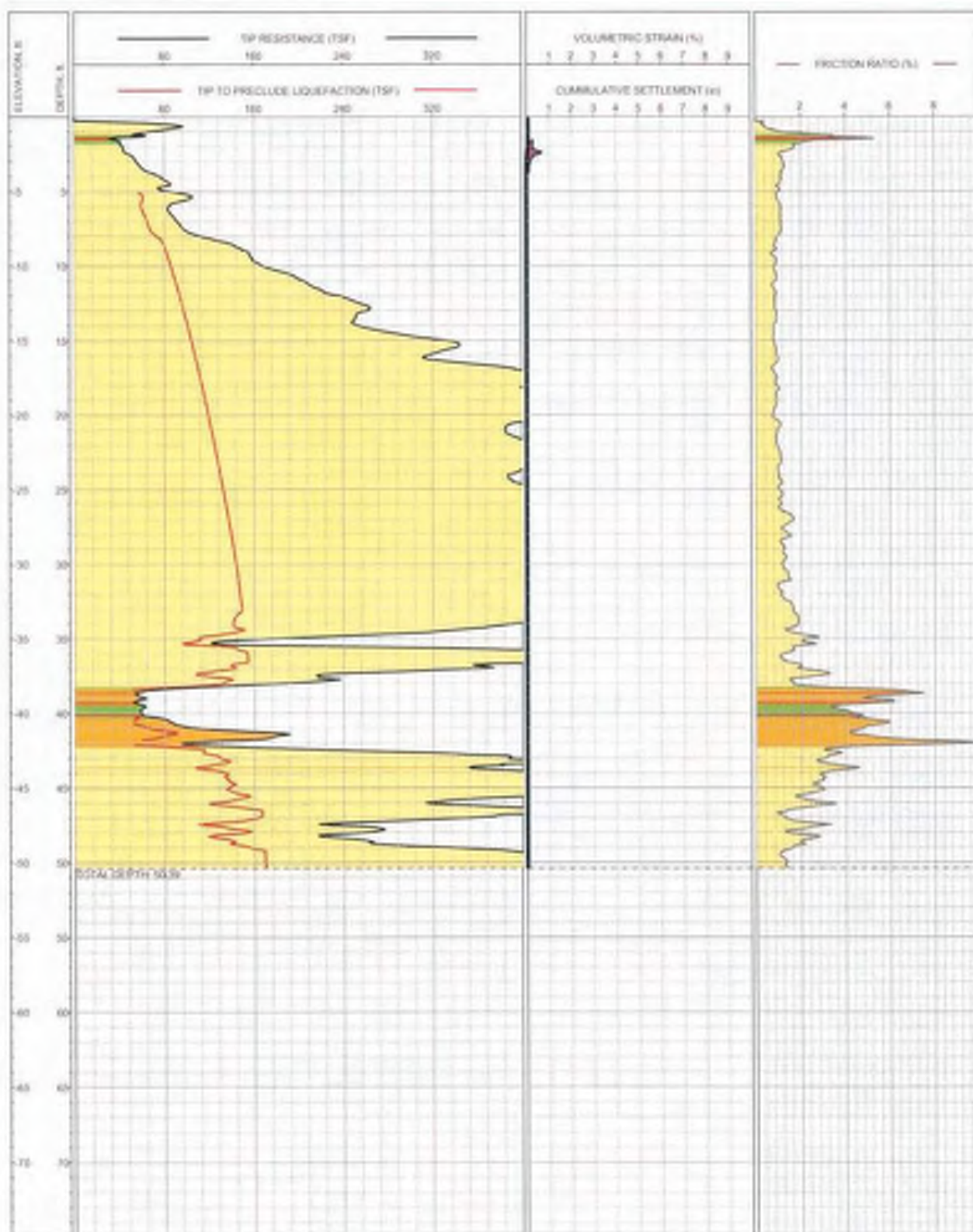

Magprobe 0.8  
 Acceleration 0.4

**LOG OF CPT  
 SOUNDING CPT-17**  
 Los Osos Wastewater Project  
 San Luis Obispo, California



PROJECT NO	3055.001	COORDINATES	N2112210 E3115264	VEHICLE	
SOUNDING	GCPT-02	GROUND ELEVATION	92.7 ft	TEST DATE	12-08-03 AM

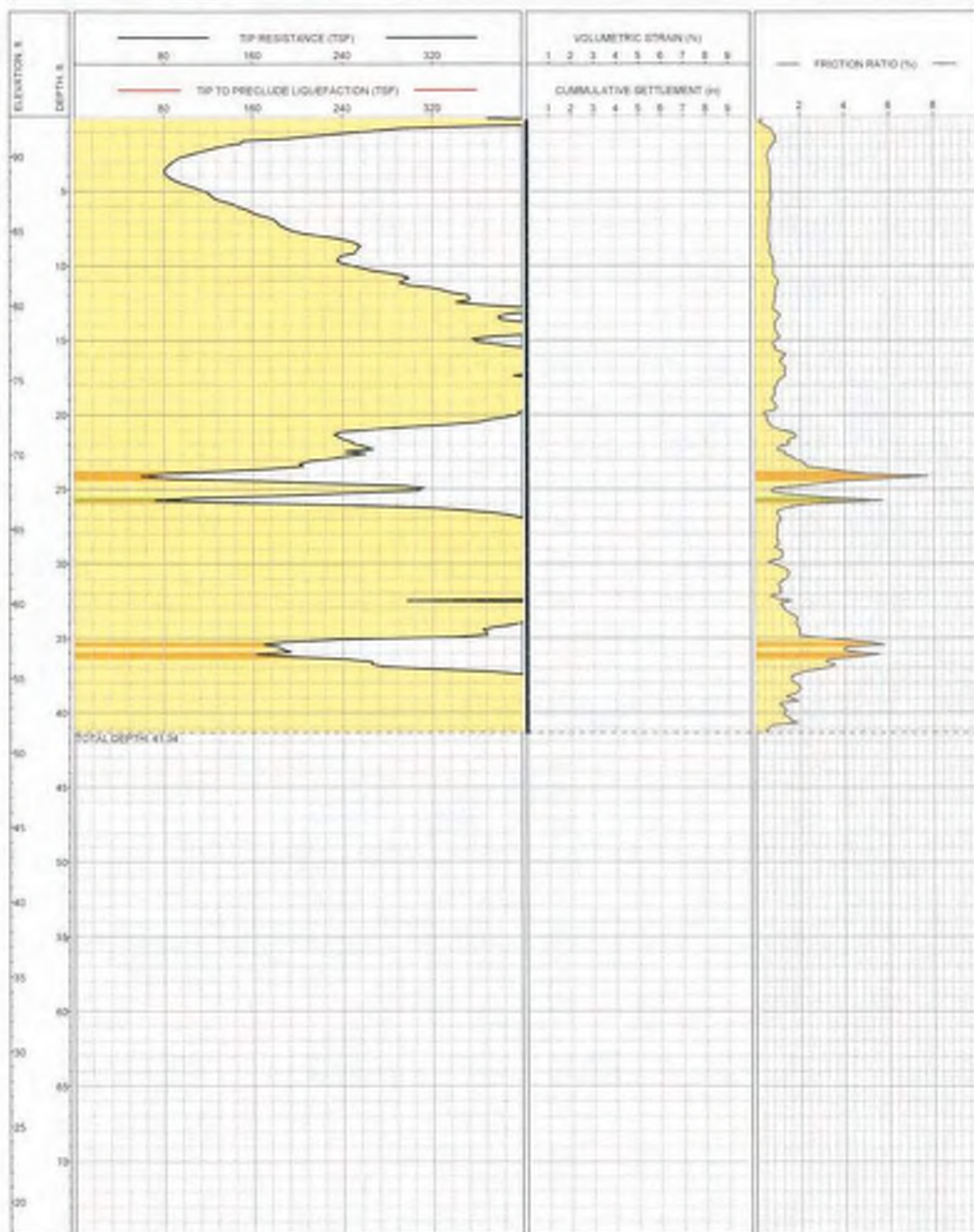

Magnitude 4.3  
 Acceleration 0.4

**LOG OF CPT**  
**SOUNDING GCPT-02**  
 Los Osos Wastewater Project  
 San Luis Obispo, California



PROJECT NO	3055.001	COORDINATES	N251182W E371557E	VEHICLE	
SOUNDING	GCPT-03	GROUND ELEVATION	101.8.8	TEST DATE	12.00.00 AM

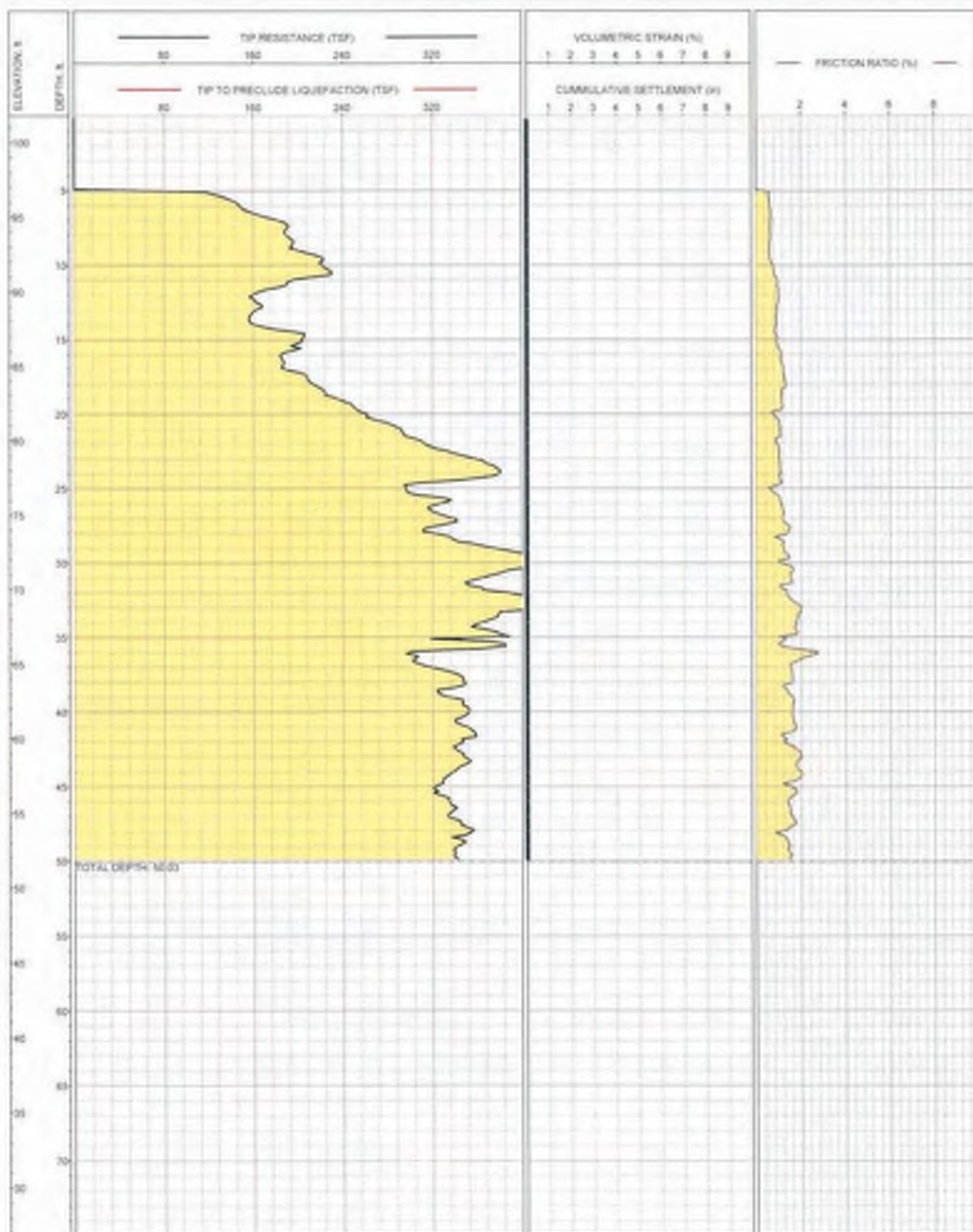

Magnitude 9.8  
 Acceleration 0.4

**LOG OF CPT**  
**SOUNDING GCPT-03**  
 Los Osos Wastewater Project  
 San Luis Obispo, California



PROJECT NO	3055.001	COORDINATES	N2311325 E3714811	VEHICLE	
SOUNDING	GCPT-04	GROUND ELEVATION	99.3.1	TEST DATE	12/05/00 AM

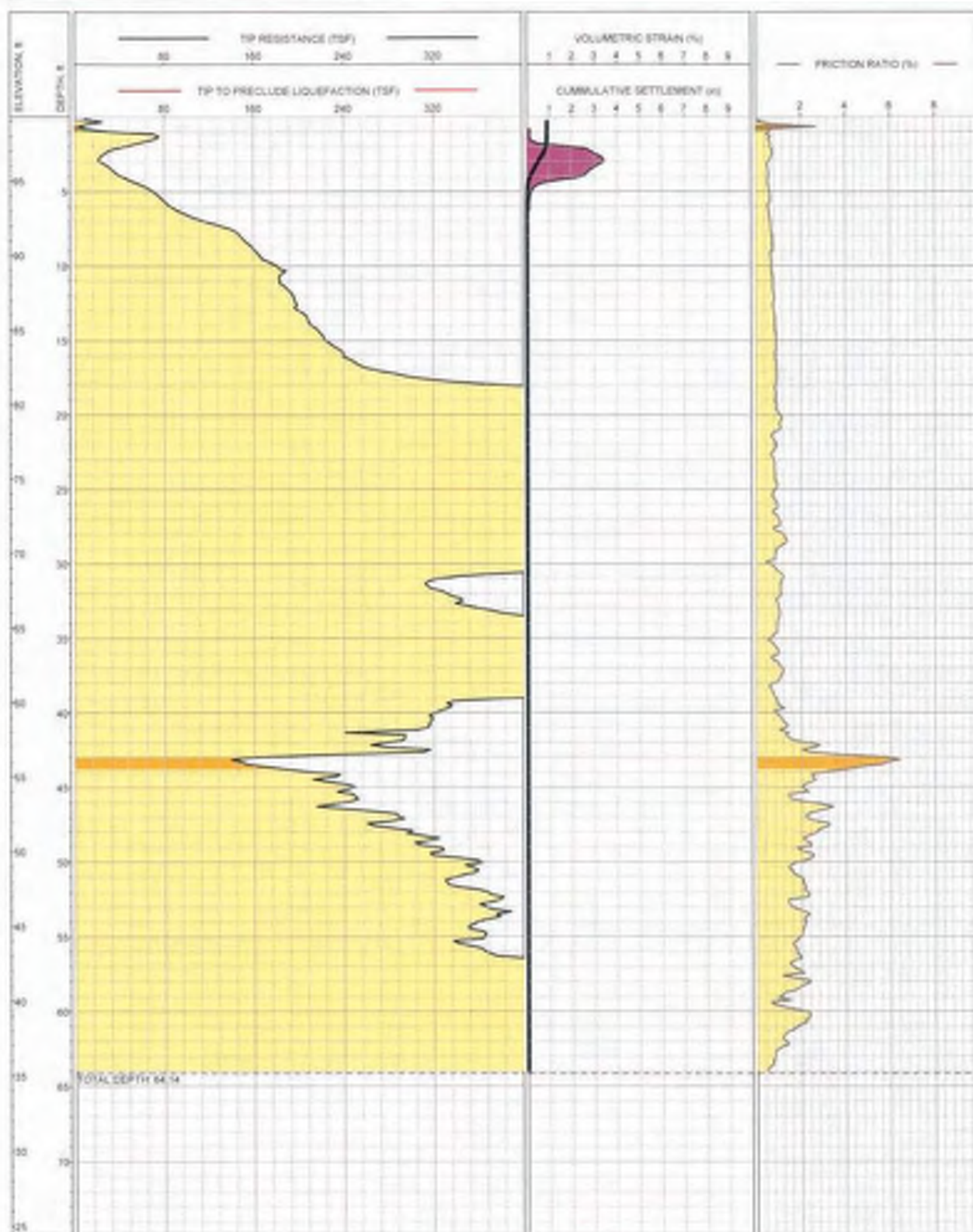

Magnitude: 8.8  
 Acceleration: 0.4

**LOG OF CPT**  
**SOUNDING GCPT-04**  
 Los Osos Wastewater Project  
 San Luis Obispo, California





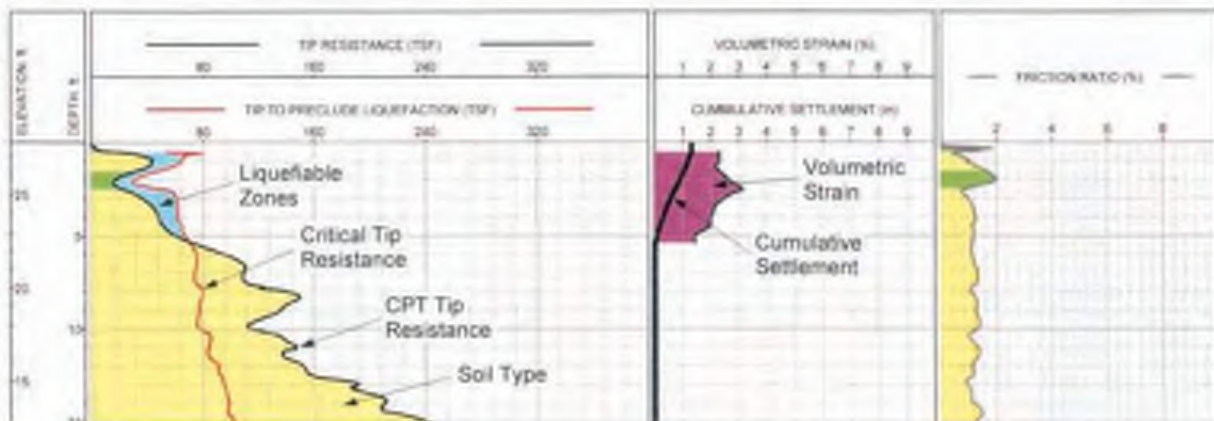

**COLOR LEGEND FOR FRICTION RATIO TRACES**

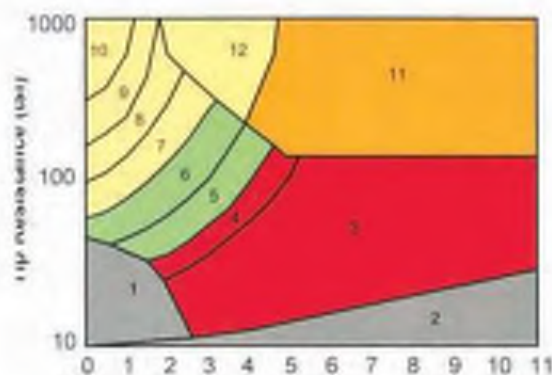

Zone	Soil Behavior Type	U.S.C.S.
1	Sensitive Fine-grained	OL-CH
2	Organic Material	OL-OH
3	Clay	CH
4	Silty Clay to Clay	CL-CH
5	Clayey Silt to Silty Clay	MH-CL
6	Sandy Silt to Clayey Silt	ML-MH
7	Silty Sand to Sandy Silt	SM-ML
8	Sand to Silty Sand	SM-SP
9	Sand	SW-SP
10	Gravelly Sand to Sand	SW-GW
11	Very Stiff Fine-grained *	CH-CL
12	Sand to Clayey Sand *	SC-SM

\*overconsolidated or cemented

**CPT CORRELATION CHART**  
(Robertson and Campanella, 1984)

**KEY TO CPT LOGS**  
**Los Osos Wastewater Project**  
San Luis Obispo, California