

# *County of San Luis Obispo*



## *2014 Bridge Maintenance Program*



*Department of Public Works  
Transportation Division*

**County of San Luis Obispo  
Department of Public Works  
Transportation Division**

July 6, 2014

Prepared by  
**Department of Public Works**

Paavo Ogren, Director  
Dave Flynn, Deputy Director Administration  
Glenn Marshall, Transportation Division Manager  
Don Spagnolo, Transportation Programs Manager  
Frank Cunningham, Bridge Maintenance Engineer

*Cover photo: Moonstone Beach Drive Bridge*

# Table of Contents

	Page
I. Introduction.....	1
II. Bridge Inventory .....	3
III. Bridge Inspections .....	6
IV. Load & Height Restricted Bridges.....	8
V. Replacement and Rehabilitation.....	9
VI. Bridge Preventive Maintenance.....	13
VII. Routine Bridge Maintenance .....	17
VIII. Funding Sources.....	17
IX. Bridge Construction/Accomplishments 2007-2013 .....	20
X. Glossary of Bridge Terminology.....	21
Basic Bridge Elements .....	22
Appendix A: Inventory of All San Luis Obispo County Maintained Bridges .....	23
Appendix B: Caltrans Structure Maintenance and Investigations List (NBI) .....	30
Appendix C: Total Bridges per County.....	38
Appendix D: Average Age of Bridge Populations by County in California .....	40
Appendix E: Bridge Replacement Program.....	42
Appendix F: List of Weight-Restricted Bridges and Strategy .....	44
Appendix G: Sample State Bridge Inspection Report (BIR) .....	46
Appendix H: Sample SLO County Bridge Inspection Form .....	52
Appendix I: Post-Earthquake Bridge Inspections Memorandum .....	56
Appendix J: List of Stream Crossing Locations and Potential Fish Barriers.....	65

# I. Introduction

In amongst California's extensive roadway network lies 12,287 bridges. Of those, 375 bridges 20 feet or longer are located in San Luis Obispo County. The County maintains almost 200 of these bridges, with the remainder maintained by the cities. The oldest County bridge still in operation today is the Santa Rosa Creek Road Bridge No. 3, a 10 ft. long concrete arch over the Santa Rosa Creek outside Cambria.



*Perfumo Canyon Road over the Perfumo Canyon Creek*

Many bridges were built during the Great Depression, with help from the Work Projects Administration (WPA). Twelve bridges were built in 1940 alone. More recently, however, fifteen vehicle bridges and two pedestrian bridges have been constructed since 2000. The Las Pilitas Pedestrian Bridge over the Salinas River has been designated as historic, while the River Grove Drive bridge over the Estrella River is eligible for such classification. The newest bridge is under construction on Main Street in Cambria over the Santa Rosa Creek, and is scheduled to be completed in 2014.

The Bridge Maintenance Program is an integrated and comprehensive strategy to effectively and efficiently maintain and preserve the County's bridge infrastructure.

The three main Bridge Maintenance Program goals are to:

1. Provide a general understanding of County bridge maintenance and replacement utilizing federal funding programs and local roads funding.
2. Preserve bridge infrastructure by maximizing its useful life through active maintenance, retrofitting, and rehabilitation.
3. Provide a prioritized list of bridge projects to assist the County in developing a maintenance program.



*Las Pilitas Rd. Pedestrian/Bike Bridge over the Salinas River*

Emphasis will be placed on preserving the existing bridge infrastructure and optimizing the use of any available federal funding for preventive bridge maintenance from the Highway Bridge Program (HBP). However, when a bridge needs to be replaced, it is equally important to also optimize the use of available federal replacement funding from the HBP.

Bridge maintenance that utilizes federal funding generally includes a number of repair programs and bridge rehabilitation programs to ensure that the useful life of the current bridge inventory is maximized. When repair or rehabilitation is not feasible, replacement, load restrictions or bridge closures may be required.

A key component to the bridge maintenance program is a well-structured bridge inspection program. Bridges that exceed 20 feet in length and listed on the National Bridge Inventory (NBI) (137 bridges) are inspected by Caltrans Structures Maintenance and Investigations (SM&I) engineers. These NBI bridges are routinely inspected every 2-years, or if new, then every 4-years. The bridge inspection reports (BIR's) are usually submitted to the County approximately 6-months after the field inspection. County staff, in many cases, does a follow-up inspection to take pictures and field notes.



*Chimney Rock Road over the Las Tablas Creek*

The County further widens the definition of bridges to include structures less than 20 feet in length, but longer than 10 feet. This includes concrete structures such as box culverts. Bridges that are not on the NBI and 20 feet or less (49 bridges total) are inspected by County staff every five years using a SLO County - Bridge Inspection Form. See Appendix H.

Together these inspections enable County staff to determine the most appropriate bridge maintenance strategies and better target funding opportunities.

Routine bridge maintenance is defined as regularly preserving bridge components in their present or intended condition. This generally includes minor work that is normally done by in-house bridge maintenance crews, including replacing damaged bridge transition and approach guardrails, graffiti removal, maintaining warning signs and object markers at approaches, clearing brush and overgrowth at bridge ends, minor concrete repairs, cleaning and flushing deck drains, and cleaning/clearing debris from decks, sidewalks, waterways, and deck joints.



*Dana Foothill Road over the Deleissigues Creek*

Routine maintenance is primarily accomplished with County forces utilizing the County SAP "Notification" and "Work Order" system. Maintenance of the bridges

and bridge assets is the responsibility of the Public Works Department - Transportation Division. The Road Crews are a part of the Transportation Division, and since 2014 have been divided into various working groups:

- Transportation engineering and management – 9 people
- Sign and Striping crew – 6 people
- Bridge and Tree Maintenance crew – 11 people
- South and Coastal County road crew – 22 people
- North and Eastern County road crew – 20 people

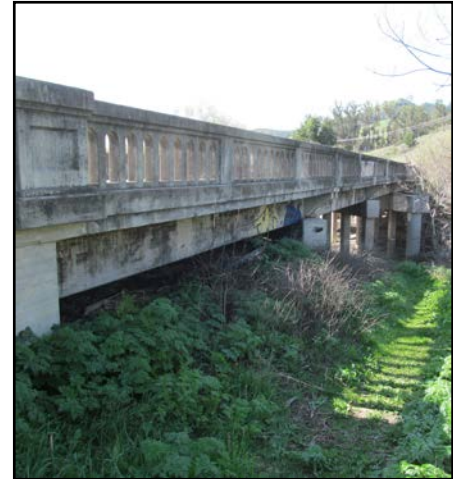

*South Higuera Street over the San Luis Obispo Creek*

Based on field inspections and maintenance crew field observations, a list of routine bridge maintenance projects are developed and maintained each year for County forces to program, schedule, and repair. Maintaining bridge structures made of various materials while managing the allocated resources is part of the County's bridge management and maintenance practices.

## **II. Bridge Inventory**

The bridge inventory includes a total of 186 bridges owned and maintained by the County in the following categories: The County currently has 137 bridges listed in the Nation Bridge Inventory that meet or exceed 20ft in length and are routinely inspected by the Structures Maintenance and Investigation Division of Caltrans. There are 50 bridges between 10ft and 20ft in length that are inspected by staff and maintained by the County bridge crew using road funds.



*North River Road over the Huero Huero Creek*

The existing 187 County bridges consist of:

- 35 Timber bridges
- 19 Steel Beam/ Truss Bridges
- 3 Combination Wood/Steel/Concrete Bridges
- 130 Concrete bridges

There are 12 bridges or 8.76% of the NBI listed bridges and 6.42% of all County bridges that are listed as structurally deficient (SD) by Federal Highway Administration (FHWA) standards. Of these there are currently 7 bridges programmed in

the Federal Transportation Improvement Program (FTIP) for replacement using federal funding.

There are 18 bridges, mostly wood, that are posted for weight restrictions, 3 of which are currently programmed for replacement using federal HBP funding. There are also 7 bridges that could potentially be removed from the system since they are no longer needed or on "dead end" roads including:

- Huasna Road over the Huasna River
- Huasna Townsite Road
- Old Creamery Road
- Negranti Road
- Green Valley Road
- Toro Creek Road off Route 41
- Morretti Canyon Road

Low water crossings are public road crossings other than bridges where construction improvements have been made in the creek or river bed to provide a firm surface for vehicles to travel across the water course. The crossings are designed and constructed to be passable to traffic most of the year during periods of ordinary creek flow but are impassable to traffic during periods of high water. The following low water crossings could be considered for replacement with a bridge structure:

- Cecchetti Road
- Airport Road
- O'Donovan
- River Road (south of Estrella)
- Penmen Springs
- San Marcos Road (2)
- San Juan Road
- Shell Creek Road
- Upper Lopez Canyon Road (several)
- Soda Lake Road

**Figure 1: Number of Bridges Statewide That Are Maintained by Local Agencies, Distributed by Age of Bridges**

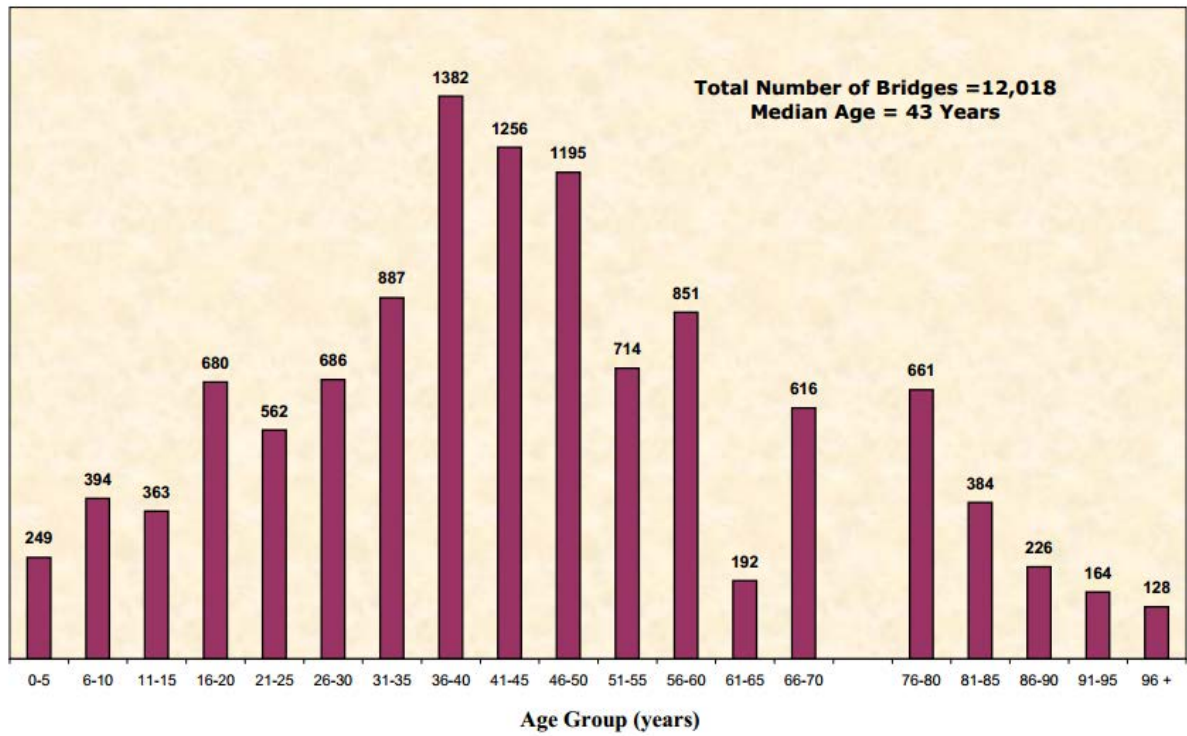

The bridge on River Grove Drive over Estrella River has recently been classified as eligible for historic significance making it the second bridge in the County with that distinction. The Las Pilitas Road Bridge, a pedestrian bridge is the other.

NBI bridges are typically identified by the bridge name followed by the bridge number, e.g., Adobe Way, 49C456. Some older bridges that are less than 20 feet also have a 49C designation, but are not listed on NBI and will lose that number upon replacement. A complete bridge inventory spreadsheet is provided in Appendix A. The map on the following page illustrates the distribution of maintained bridges throughout the County.



# Locations of County-Maintained Bridges - 2014

County of San Luis Obispo, CA



## Legend

- Bridge Over 20' in Length
- ◆ Bridge 10'-20' in Length
- Pedestrian Bridge
- Incorporated City Limits

### III. Bridge Inspections

The National Bridge Inspection Standards (NBIS) mandates that public agencies inspect and report on all bridges at least once every two years. Under these standards, the county is required to document and report the current condition of each bridge, determine the degree of wear or deterioration, and recommend repairs or needed services. Bridges deficient in their conditions, such as load restricted bridges, may require more frequent inspections.

During the bridge inspections, Caltrans and the County Bridge Engineer make an in-depth evaluation of the condition of the bridge structure and document any observable deficiencies on a State Bridge Inspection Report (BIR) (See sample - Appendix G). County staff uses a similar form (See Appendix H). These noted deficiencies are classified into bridge replacement, major rehabilitation, preventive repair work, or routine repairs. These classification groups are explained in more detail later in this report. Any urgent structural or safety concerns of inspected bridges are addressed promptly.

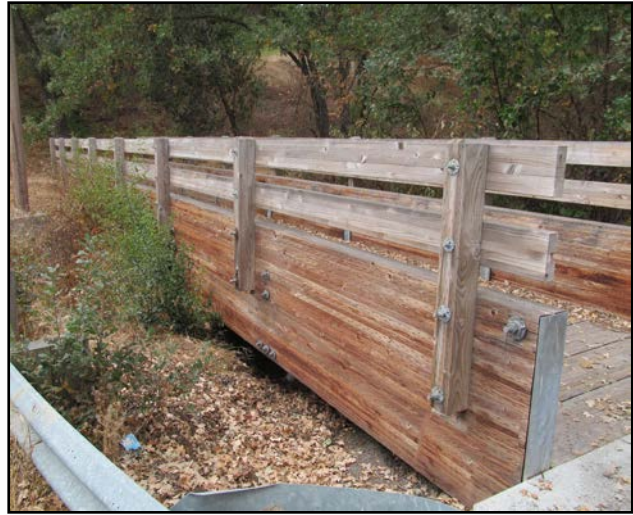

*Florence Street Pedestrian Bridge over the Templeton Creek*

One measure that provides an overview of the condition of the bridge inventory is known as the Sufficiency Rating (SR). The SR is a bridge's relative ability to serve its intended purpose. The sufficiency rating is the summation of four calculated values: Structural Adequacy, Safety, Serviceability, and Functional Obsolescence.

The SR is calculated for each bridge using the ratings the inspector assigns to individual features of the bridge. Geometric layout, traffic volume, and the length of the detour route is also used in calculating the SR. The SR ranges from zero (a bridge that is closed and cannot carry traffic loads) to 100 (a new bridge with no deficiencies).

The average SR of the entire inventory provides a comparative look at the health of the inventory from one year to the next. Appendix B contains a list of all Caltrans-inspected bridges in the County and their respective SRs.

**Figure 2: Average Annual Sufficiency Rating (SR) of San Luis Obispo County Bridges**

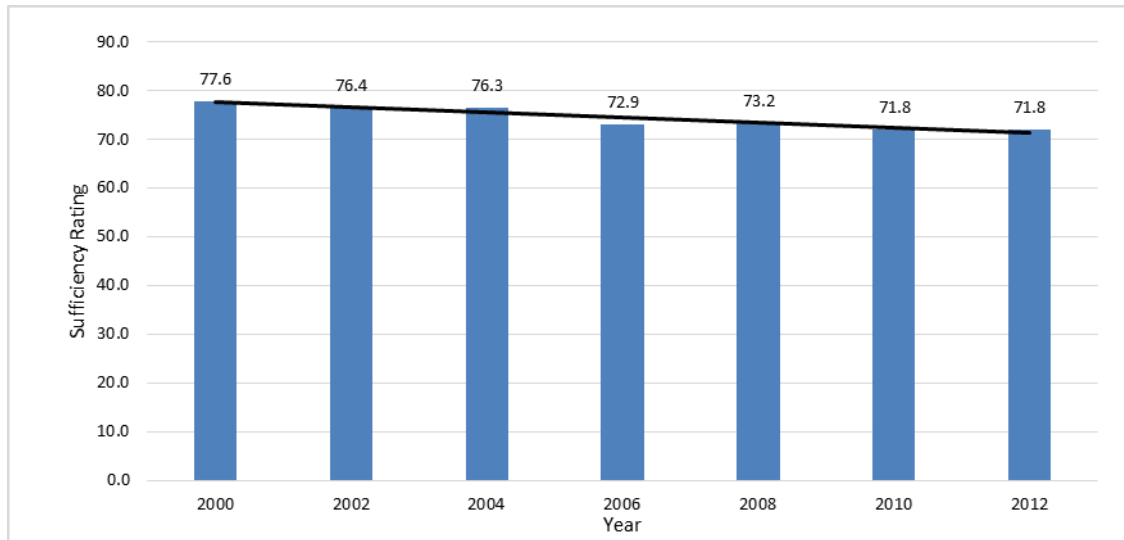

Overall, the SR for the County bridge inventory has varied little over the past years. This is due to the large number of bridges in the inventory, which prevents the benefit of each year’s new bridges and new repairs from significantly increasing or decreasing the SR average. Considering the inventory continues to age, maintaining the current average SR is a significant accomplishment, which represents the County’s investment in replacing the most deficient bridges while the remainder of the inventory is kept in a state of good repair. In addition to using the SR as a measure of the condition of a bridge, the NBI defines two types of deficient bridges – structurally deficient (SD) and functionally obsolete (FO).

A **structurally deficient bridge (SD)** as defined by the Federal Highway Administration (FHWA), is one whose condition or design has impacted its ability to carry its intended traffic loads. Examples include bridges that have significant load carry elements that are found to be in poor condition due to deterioration or damage and/or the inadequacy of waterway opening provided by the bridge, which can cause flooding over the bridge deck or adjacent roadway having the potential to cause significant traffic interruptions. The fact that a bridge is “structurally deficient” does not mean or imply that the bridge is unsafe or is likely to collapse. It does however indicate that when left open to traffic, it typically requires significant maintenance and repair to remain in service and ultimately will require replacement or major rehabilitation to address the deficiencies.



*River Grove Drive over the Estrella River*

A **functionally obsolete bridge (FO)** is one in which the deck geometry, load carrying capacity, clearance, or approach roadway alignment has reduced its ability to adequately meet the traffic needs, and is below accepted design standards. While structural deficiencies are generally the result of deterioration of bridge components, functional obsolescence typically results from older bridge designs that are subject to increased traffic demands and are substandard structures as defined by the current bridge design codes. Examples include narrow lane/shoulder widths, weight restrictions, and height restrictions of less than 14 feet (See Appendix B).

#### Post Earthquake Bridge Inspections

Bridge inspections are also performed after earthquakes in accordance with Procedural Memorandum M-40. See Appendix I.



*Air Park Road Bridge over the Oceano Lagoon*

## **IV. Load & Height Restricted Bridges**

When a bridge deficiency is severe and repairs cannot restore full load capability, the bridge is designated as load restricted and advanced warning signs are erected at each end of the bridge restricting heavy loads. Each bridge is required to have a “Load Rating” calculation. The Load Rating establishes how much weight the bridge can carry for several standard configurations of vehicle axle loads. As of 2014, the County has 6 bridges 20-feet and longer and 10 bridges less than 20-feet long that have posted load restrictions. There are four of these bridges programmed for replacement or rehabilitation using federal funding. See Appendix A for the load restricted bridges. The County has also developed a “List of Weight Restricted Bridges.” See Appendix F.

Bridges that have traffic portals (heights) of 15.5-feet or less are required to be posted with warning signs that state the allowable height restriction. There is only one height restricted bridge in the County’s jurisdiction. It is located on River Grove Drive over the Estrella River

and is currently programmed for rehabilitation work. Because this bridge is deemed to have historical significance, it has not been determined if the rehabilitation work can mitigate the height restriction.

## V. Replacement and Rehabilitation

The County presently has 10 bridges over 20 feet with an SR below 50. These bridges are listed in the bridge replacement program spreadsheet in Appendix E. They are scheduled for replacement over the next seven years. Priority for replacement is given to bridges with higher traffic volume when sufficiency ratings the same. Future bridge projects will be selected for replacement when their SR falls below 50.

The replacement and rehabilitation program is scheduled to complete one or two replacements each year. The program also includes replacement of low water crossings and seismic retrofits that could be damaged in the event of an earthquake.

There are two financial components of bridge replacement/rehabilitations. Some bridges (typically if 20-feet long) are eligible for federal “Highway Bridge Program” (HBP) funding.



*N. River Road over the Salinas River*

Other bridges, (typically if less than 20-feet long) are not eligible for federal funding and local funding is required, as outlined below. Bridges should also be evaluated to determine if it spans a creek that serves as a fish passage as identified in the San Luis Obispo County Stream Crossing Inventory and Fish Passage Evaluation report published in March 2005. The report identifies fish passages in the County that pose a potential barrier for steelhead trout, see Appendix J. Bridges on the list which will be replaced may be eligible for funds from the Department of Fish and Wildlife as mitigation for fish barriers.

In order for a bridge to qualify for federal bridge replacement or rehabilitation funding (HBP) it must meet specific criteria established by the Local Assistance Procedures Manual and Program Guidelines. This typical federal program is usually funded at 88.53% federal funds and 11.47% from the local agency. There are other possible funding programs such as Toll Credits and STP funds, however these funding programs are currently changing and may not be consistently available in the near future.

The basic qualifications for federal bridge funding include:

For Bridge Replacements:

1. Bridge is listed on the National Bridge List (NBI)

2. Bridge Inspection Reports from SM&I have to indicate an SR < 50.
3. Being rated Structurally Deficient (SD) or Functionally Obsolete (FO) on the BIR may also be a secondary tool by which to prioritize projects.
4. Bridge rehabilitation is not a cost-effective option.
5. As a general rule, typically local agencies can program two (2) bridges per fiscal year for replacement.



*San Simeon Creel Road over the San Simeon Creek*

For Bridge Rehabilitations:

1. Bridge is listed on the National Bridge List (NBI)
2. Bridge Inspection Reports (BIR) from SM&I have to indicate an SR < 80.
3. The bridge must be on the Eligible Bridge List (EBL) by being rated Structurally Deficient (SD) or Functionally Obsolete (FO) on the BIR.

Generally speaking, bridges with a SR greater than 50 have a fair amount of useful life remaining. Bridges with a SR less than 50 require more attention and may need major repairs or complete replacement.

Table 1 on the next page lists bridges that are currently programmed for replacement or rehabilitation using HBP funding. A complete list of bridges to be replaced and their funding requirements is shown in Appendix E.



*Trout Farm Road Bridge over Arroyo Grande Creek*

**Table 1: Upcoming HBP Funded Bridge Work**

Bridge Name	Bridge Number	Type of Work	Anticipated Year to Begin Work
Main Street Bridge at Santa Rosa Creek	49C0337	Replacement	2013
Branch Mill Road Bridge at Tar Springs Creek	49C0143	Replacement	2014/15
River Grove Drive Bridge at Estrella River - Historically Significant	49C0307	Rehabilitation	2015/16
El Camino Real Road Bridge at Santa Margarita Creek	49C0310	Replacement	2018/19
Air Park Drive Bridge at Ocean Creek	49C0125	Replacement	2018/19
Cypress Mountain Road at Klau Creek	49C0033	Replacement	2015/16
Geneseo Road Low Water Crossing at Huer Huero Creek	N/A	New Bridge	2016/17
Huasna Road Bridge at Huasna River	49C0274	Replacement	2020/Beyond
Avila Beach Drive over San Luis Obispo Creek	49C0327	Seismic Retrofit	2017/18
South Bay Boulevard Bridge over Los Osos Creek	49C0351	Seismic Retrofit	2019/20
Lopez Drive Bridge over Lopez Lake	49C0354	Seismic Retrofit	2017/18
Jack Creek Road Bridge	49C0342	Replacement	2018/19
Toro Creek Road Bridge	49C0384	Replacement	2018/19
Dover Canyon Road Bridge	49C0037	Replacement	2017/18
Huasna Road Bridge at Arroyo Grande Creek	49C0124	Rehabilitation	2020/Beyond

The map on the following page shows the location of programmed bridges that are expected to be replaced or rehabilitated within the next few years.

Local County Road Funds are used to replace County bridges that are less than 20-feet long and do not qualify for federal bridge funding. San Luis Obispo County currently has 49 such bridges.



*AG Huasna Road over the Huasna River*





This routine work which does not qualify for federal funding is documented in a spreadsheet and noted in the County’s SAP system via a “Notification” and when the bridge crews are ready they will issue a SAP “Work Order” to track the repair costs.

**Table 2: Weight Restricted Bridge Mitigation Plan**

Priority	Bridge Name	Replacement Strategy	Cost
1	Morretti Cyn Rd - B1	Replaced with HDPE Pipe	\$20,000
	Morretti Cyn Rd - B2	Replaced with HDPE Pipe	\$20,000
	Morretti Cyn Rd - S1 (not posted)	Replaced with HDPE Pipe	\$15,000
2	Suey Creek Rd	Replace with PC/PS Conc Slab	\$200,000
3	Morretti Cyn Rd - B3	Replace with PC/PS Conc Slab	\$100,000
	Morretti Cyn Rd - B4	Replace with PC/PS Conc Slab	\$100,000
4	Upper Los Berros Road - B5	Replace with PC/PS Conc Slab	\$150,000
	Upper Los Berros Road - B6	Replace with PC/PS Conc Slab	\$150,000
5	Upper Los Berros Road - B7	Replace with PC/PS Conc Slab	\$150,000
	Upper Los Berros Road - B8	Replace with PC/PS Conc Slab	\$150,000

Note: Dover Cyn Rd, Huasna Townsite Rd, Monte Rd, Trout Farm Rd, Air Park Rd, and River Grove Dr bridges are all currently soon-to-be programmed in FTIP for replacement or major rehabilitation. Trout Farm Rd and Dana Foothill Rd bridges are currently being re-evaluated due to recent repair/rehabilitation work. Projects will be processed based on priority and available funding.

## VI. Bridge Preventive Maintenance

Bridge repairs that have been identified either through routine inspections or SAP work orders may be combined and submitted as part of the HBP program. These projects typically include structural concrete repairs, wood lagging replacement, scour repairs and concrete deck sealing.

Similar to the bridge replacement and rehabilitation section, there are two clear financial components of bridge preventive maintenance projects. Some bridges (typically if 20 feet or longer) are eligible for



*North Ocean Avenue over the Cayucos Creek*

federal HBP Bridge Preventive Maintenance Program (BPMP) funding. Other County bridges, (typically if less than 20 feet long) are not eligible for federal funding and local road funding is required.



*Pecho Road over the Islay Creek*

In order for a bridge to qualify for BPMP funding it must meet specific criteria established by the Local Assistance Procedures Manual and Program Guidelines. This federal program is typically funded at 88.53% federal funds and 11.47% from the local agency. Under BPMP, local agencies can receive federal funding to perform certain pre-approved preventive maintenance (PM) activities to extend the life of their bridges. Generally, all bridges with spans 20-feet and over are eligible. The goal of this program is to extend the life of eligible bridges by correcting minor structural defects early, rather than allowing deficiencies to worsen over time.

As bridges begin to age, certain bridge components require repair. The County's preventive maintenance program is designed to repair and replace worn or broken bridge components. This work is intended to extend the life of the bridge inventory and corrects any immediate safety deficiencies. The secondary goal of the repairs is to also remove hazards and provide for preservation of infrastructure in a cost-efficient manner.

Common repairs include replacing cracked concrete bridge decks or treating them with a methacrylate coating, replace rotted timbers, bridge painting, repair corroded steel, replace deck joint seals, or repair/replace otherwise deteriorated structural components of the bridges.



*Pozo Road over the Salinas River*

The following are typically not eligible:

- Bridges with spans less than 20' long and therefore not on the EBL or NBI lists.
- Bridge rail replacement to upgrade to crash tested standards.
- Routine maintenance (regularly scheduled activities to preserve bridge components in their present or intended condition, including rail repair due to accidents, clearing brush, shoring bridges with load carrying problems).
- New scour countermeasures.

Types of BPMP repairs that are eligible include:

- Methacrylate deck treatment or polyester concrete overlay.
- Replacement of expansion joint seals and assembly.
- Deck AC replacement.
- Repairing, restoring, or strengthening of major structural elements.
- Repairing, replacing, or supplementing timber structural elements, timber railings, timber deck runners (excluding a full deck replacement).
- Retrofit repairs to fatigue prone details of steel girders.
- Replacement of deteriorated bridge railing. Environmental damage is considered preventive maintenance, but damage from car strikes or upgrades to crash test standards are not.
- Repair of existing scour countermeasures, however new scour countermeasures are not funded under the BPMP.
- Painting.



*El Camino Real over the Santa Margarita Creek*

Painting a bridge is a significant endeavor. The amount of surface area coated is small, but the work to create a containment system and scaffolding for access to the underside of the bridge would require significant effort. A containment system supported by the bridge would be put in place as the sandblasting was performed and paint was applied.



*New Main Street Bridger over the Santa Rosa Creek, Cambria*

Considering all the listed requirements and eligible work items of the BPMP, a current list of County bridge preventive work candidates is shown in Table 3 on the next page.

The list of eligible bridges for preventative work is in constant change. The most urgent repairs get programmed each year, or as needed to efficiently utilize federal funds for eligible work.

**Table 3: Bridge Preventative Maintenance Program**

Description	County Bridge No.	Sufficiency Rating	SD/FO Status	Work Description	Participating Cost	Federal Share	Local Share
Develop Next Year's BPMP				Develop Annual Bridge Preventive Maintenance Program	\$25,000	\$22,133	\$2,868
Preliminary Engineering and Env. Phase - 14/15				Perform Preliminary Engineering and Environmental	\$140,000	\$123,942	\$16,058
ROW and Utility Phase - 15/16				Perform ROW and Utility Needs & Certification	\$40,000	\$35,412	\$4,588
Construction Management Phase - 15/16				Perform Construction Management Services	\$85,000	\$75,251	\$9,750
Toro Creek Road Bridge	4001-B1	65.5		Remove and replace abutment/WW wood lagging (2)	\$120,000	\$106,236	\$13,764
Pippin Lane Bridge	2086-B1	65.8	FO	Remove and replace abutment/WW wood lagging (2)	\$120,000	\$106,236	\$13,764
Villa Creek Road Bridge	4292-B2	82		Remove and replace abutment/WW wood lagging (1)	\$75,000	\$66,398	\$8,603
Picachio Road Bridge	4296-B2	68	FO	Remove and replace abutment/WW wood lagging (2)	\$100,000	\$88,530	\$11,470
Lopez Drive Bridge (Spillway)	2019-B1	91.4		Remove and Replace Deck Joint Seals	\$35,000	\$30,986	\$4,015
North Ocean Blvd Bridge	4256-B1	81.3		Repair bridge soffit concrete and rusted rebar	\$45,000	\$39,839	\$5,162
Nacimiento Lake Drive Bridge	5277-B1	83		Scour mitigation along downstream side	\$30,000	\$26,559	\$3,441
North River Road Bridge	5252-B1	78.1		Remove and replace abutment/WW wood lagging (1)	\$85,000	\$75,251	\$9,750
<b>Totals</b>					<b>\$900,000</b>	<b>\$796,770</b>	<b>\$103,230</b>

The project funding will be administered by Caltrans and is scheduled for preliminary engineering in FY 2014/15, right of way acquisition in FY 2015/16, and construction in FY 2016/17.

Most of these bridge deficiencies are typically noted on the bridge inspection reports (BIR's) and recommended repair work. These repairs are detailed by the inspecting engineers and tracked on the biennial BIRs until work is either done with County forces (not eligible for federal funding) or by contract (eligible if programmed in accordance with Local Assistance Procedures Manual and Program Guidelines). County staff also reviews the BIR's and performs field inspections to assist in project descriptions, scope, and cost prioritization based on available funding options. While major repair, rehabilitation, and replacements are typically programmed for federal funding, prevention work has to be further evaluated based on scope (does it qualify for federal funding?), urgency of repairs (programming takes 4-7 years), and cost effectiveness (is the recommended work just simpler and easier to do in-house?).

If the recommended work does not qualify for federal funds, cannot wait for years, or is just simpler to be done by County forces, the work is noted in the County's SAP system via a "Notification" and when the bridge crews are ready they will issue a SAP "Work Order" to charge and track costs associated with the repairs.

## VII. Routine Bridge Maintenance

Bridge deficiencies, including routine work, are typically noted on the bridge inspecting reports (BIR's) and also on the County bridge inspection forms for the bridges less than 20-feet long. These minor repairs are also detailed by the inspecting engineers and tracked on the biennial BIRs or County spreadsheet until work is done with County forces.

Work Order repairs range in size and complexity and can include work such as:

- Vegetation removal
- Wood deck nail replacement
- Vehicle damage repairs
- P-marker replacement
- Deck repairs
- Minor concrete repairs



*South Bay Boulevard over the Los Osos Creek*

## VIII. Funding Sources

The Federal Highway Administration estimates that to eliminate the bridge backlog by 2028, the nation would need to invest \$20.5 billion annually; however, at this time only \$12.8 billion is being spent annually on the nation's bridges. There are 137 County bridges listed on the National Bridge Inventory (NBI) which are eligible for Federal funding and 49 bridges less than 20 feet in length that are not eligible for federal funding. Bridges not eligible are funded from the Road Fund.

### Replacement and Rehabilitation Program:

The total amount for bridges scheduled for replacement through 2019 is \$69.1 million from the Highway Bridge Program (HBP), of which \$7.3 million is local County funds. The costs are split with 88.53% funded through the HBP, and a local match from the County of 11.47%. The County budget includes approximately \$578,000 annually that is used as the local match for capital improvements under TEA 21. Highway Users Tax Account (HUTA) funds are used as reimbursement that go into the Road Fund.

Bridge replacement projects may also be eligible for toll credits which can be used as County matching funds. Toll credits are earned when the state, a toll authority, or a private entity funds a capital transportation investment with toll revenues earned on existing toll facilities (excluding revenues needed for debt service, returns to investors, or the operation and maintenance of toll facilities). By using toll credits to substitute for the County matching funds on a new Federal-aid project, the Federal share can effectively be increased to 100 percent.

Bridge Preventative Maintenance Program (BPMP):

Projects in the BPMP are funded as part of the HBP. The costs are split with 88.53% funded through the HBP, and a local match from the County of 11.47%. Toll credits are not available for these projects, so the local match is funded from the Road Fund and reimbursed from HUTA.



*San Luis Bay Drive over the San Luis Obispo Creek*

Routine Bridge Maintenance Program:

These projects are typically performed by the County Bridge Crew, and do not qualify for HBP funds. Funding for these projects are from the Road Funds.

**Table 4: Bridge Maintenance Program Expenditures**

Maintenance Program	FY 13/14	FY 14/15	FY 15/16	FY 16/17	FY 17/18
HBP Replacement and Rehabilitation	\$ 76,300	\$ 112,000	\$ 140,638	\$ 394,632	\$ 676,196
County Funded Replacement of Weight Restricted Bridges	\$ -	\$ 55,000	\$ 200,000	\$ 200,000	\$ -
Preventative Maintenance	\$ 103,230	\$ -	\$ -	\$ 100,000	\$ -
Routine Maintenance	\$ 75,000	\$ 75,000	\$ 75,000	\$ 55,000	\$ 70,000
<b>Total</b>	<b>\$ 254,530</b>	<b>\$ 242,000</b>	<b>\$ 415,638</b>	<b>\$ 749,632</b>	<b>\$ 746,196</b>

Note: Estimated Annual Funding \$750,000. HBP Funding includes Local Match and Indirect Costs. County funded projects will be processed based on available funds.

The recently-passed surface transportation legislation from Congress, Moving Ahead for Progress in the 21st Century (MAP-21), may eliminate the Highway Bridge Program, and may instead roll it into the National Highway Performance Program (NHPP). However, the off-system bridges are not included in the NHPP, but have been placed in the Surface Transportation Program. With the nation's bridges divided between two programs without guaranteed set-asides for repair, bridges may need to compete with other transportation programs for funding, which could have a negative impact on conditions. Bridge replacement funding may also be available from the Department of Fish and Wildlife if the project addresses mitigation of a fish barrier.



*Jespersion Road Bridge over the E. Branch of San Luis Obispo Creek*

## IX. Bridge Construction/Accomplishments 2007-2013

Bridge construction over the last six years has seen the completion of the bridges in the following table. This table does not include SAP "Notifications/Work Orders" which averages about 75 per year.

**Table 5: Bride Construction / Accomplishments over the Last Six Years**

Bridge Name	Bridge Number	Action or Repair	Approximate Project Cost	Year Completed
<b>I - Bridge Replacements/New</b>				
Tefft Street Bridge at Burton Street	49C0457	Replace	\$2,491,000	2007
Tefft Street Bridge at Avacado Ave	49C0461	Replace		2008
Picachio Road Bridge B-1	49C0443	Replace	\$1,754,000	2007
San Luis Bay Drive B-3	49C0438	Replace	\$6,800,000	2009
Turri Road Bridge B-1	49C0441	Replace	\$1,320,000	2007
Moonstone Beach Drive Bridge B-1	49C0448	Replace	\$5,030,000	2011
Ferrasci Road Bridge B-1	49C0455	New-LWC	\$1,365,000	2011
San Simeon Creek Road Bridge B-1	49C0437	Replace	\$3,756,000	2011
San Simeon Creek Road Bridge B-2	49C0436	Replace		2011
Willow Road Bridge B-1	49C0454	New	N/A	2012
Main Street Bridge-Cambria B-1	49C0458	Replace	Est. \$5,384,000	2013
<b>II - Bridge Rehabilitations</b>				
Price Canyon Road B-2 (Overhead)	49C0329	Widen-Rehab	\$2,907,000	2012
Price Canyon Road B-3	49C0330	Widen-Rehab	\$2,418,000	2012
<b>III - Bridge Preventive Work</b>				
Bridge Deck Seals	Misc	Methacrylate	\$213,500	2007
Bridge Deck Seals	Misc	Methacrylate	\$138,900	2009
Bridge Deck Seals	Misc	Methacrylate	\$266,500	2012
Mehlschau Road Bridge	49C0132 - 40084563	Scour Mitigation	\$47,000	2012
Dana-Foothill Road Bridge	49C0134 - 40081409 - 40081875	Replace wood deck/stringers	\$24,770	2012
El Camino Real Road Bridge	49C0310 - 40088634	Scour Mitigation	\$95,150	2012
AG-Huasna Road Bridge	49C0274	Wood deck repairs	\$14,100	2012
Villa Creek Road Bridge	49C0094 - 40087762	Replace wood lagging	\$34,200	2012
N.River Road Bridge B-1	49C0052	Replace wood lagging	\$7,000	2012
N.River Road Bridge B-2	49C00346	Replace wood lagging	\$82,000	2012
SLO-San Simeon Road Bridge	49C0254	Replace MBGR approach rail	\$5,000	2013
Cecchetti Road - LWC	LWC	Repair LWC structure	\$37,000	2013
Foothill Road Bridge	49C0222	Replace bridge & approach rail	Est. \$30,000	2013
North Green Valley Road Bridge	49C00291	Scour Mitigation	Est. \$10,000	2013
Cottontail Creek Road Bridge	49C0246	Scour Mitigation	Est. \$10,000	2013
Morretti Canyon Rd Bridge BS-1	Cattle X-ing	Replace wood decking	\$10,100	2013
			Total (5-year)	\$28,874,541



## X. Glossary of Bridge Terminology

**Abutment:** A substructure supporting the end of a single span, or the extreme end of a multi-span superstructure and, in general, retaining or supporting the approach fill.

**Bent:** A supporting unit of the beams of a span made up of one or more column or column-like members connected at their top-most ends by a cap, strut, or other horizontal member.

**Bracing:** A system of tension or compression members or a combination of these, connected to the parts to be supported or strengthened by a truss or frame. It transfers wind, dynamic, impact, and vibratory stresses to the substructure and gives rigidity throughout the complete assemblage. Bracing can also refer to diagonal members that tie two or more columns of a bent together.

**Bridge Railing (Traffic Barrier):** Bridge railings serve both safety and aesthetic functions in bridge projects. They are designed to safely redirect vehicles to minimize injury and damage in the case of accidents, as well as to retain pedestrians and bicyclists.

**Cap:** The horizontally-oriented, top-most piece or member of a bent serving to distribute the beam loads upon the columns and to hold the beams in their proper relative positions

**Deck:** The portion of a bridge that provides direct support for vehicular and pedestrian traffic.

**Fracture Critical Member:** A member in tension or with a tension element whose failure would probably cause a portion of or the entire bridge to collapse.

**Pier:** A structure comprised of stone, concrete, brick, steel, or wood that supports the ends of the spans of a multi-span superstructure at an intermediate location between abutments. A pier is usually a solid structure as opposed to a bent, which is usually made up of columns.

**Pile:** A rod or shaft-like linear member of timber, steel, concrete, or composite materials driven into the earth to carry structure loads into the soil.

**Scour:** Erosive action of removing streambed material and bearing capacity around bridge substructure due to water flow. Scour is of particular concern during high-water events.

**Short Span:** The characteristics of these bridges are a span less than 20 feet and typically supported by timber piles or shallow concrete footings.

**Soffit:** The underside of the bridge deck or sidewalk.

**Spall:** A concrete deficiency wherein a portion of the concrete surface is popped off from the main structure due to the expansive forces of corroding steel rebar underneath. This is especially common on older concrete bridges.

**Stringer:** A longitudinal beam supporting the bridge deck, and in large bridges, framed into or upon the floor beams.

**Sufficiency Rating:** The sufficiency rating is a numeric value from 100 (a bridge in new condition) to 0 (a bridge incapable of carrying traffic). The sufficiency rating is the summation of five calculated values: Structural Adequacy, Safety, Serviceability and Functional Obsolescence, Essentiality for Public Use, and Special Reductions.

**Sub-Structure:** The abutment, piers, grillage, or other structure built to support the span or spans of a bridge superstructure and includes abutments, piers, bents, and bearings.

**Super-Structure:** The entire portion of a bridge structure which primarily receives and supports traffic loads and in turn transfers the reactions to the bridge substructure; usually consists of the deck and beams or, in the case of a truss bridge, the entire truss.

**Trestle:** A bridge structure consisting of beam spans supported upon bents. Trestles are usually made of timber or steel and have numerous diagonal braces, both within each bent and from bent to bent.

**Wheel rail:** A timber curb fastened directly to the deck, most commonly found on all-timber bridges.

**Wing wall:** Walls that slant outward from the corners of the overall bridge that support roadway fill of the approach.

## Basic Bridge Elements

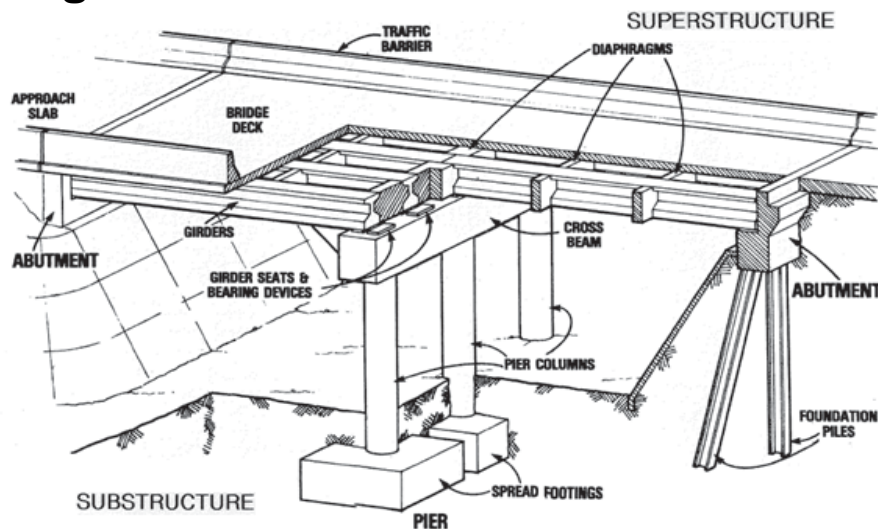

**Appendix A: Inventory of All San Luis Obispo  
County Maintained Bridges**

Object	Description	Bridge Length (ft)	Bridge Width (ft)	State Bridge Number	Road Class	Federal Aid System	Bridge Center Mile Post	Latitude at Center of Bridge	Longitude at Center of Bridge	Bridge Construction Type	Bridge Deck Covering	Load Limit Posted	Headwall/Abutment Construction	Structure Construction	Pier Construction	Piles	Number of Spans	Span Length (ft)	Year Constructed R-Rebuilt	Last Inspection Date
RD-3122-BR1	Adobe Way, Bridge 1	25	32	49C0456	M	Off	0.256	35° 21' 20.96	120° 47' 10.34	CONC BOX CULVERT	REINF CONCRETE		REINF CONC		REINF CONC		2	12	1957	S-11/10/2012
RD-1097-BR1	Air Park Dr., Bridge 1	78.7	20	49C125	M	On	0.267	35° 6' 18.21	120° 37' 33.26	WOOD	WOOD	Yes	WOOD	WOOD		WOOD	7	19	1940	S-10/19/2012
RD-2029-BR1	Alisos Rd., Bridge 1	20	20	49C0336	M	Off	0.212	35° 8' 17.49	120° 30' 51.61	WOOD	WOOD		ROCK	WOOD			1	19		C-6/14/2012
RD-2301-BR1	Arroyo Grande-Huasna Road, Bridge 1	192	16	49C0274	M	Off	2.550	35° 08' 13.00	120° 21' 32.00	Wood	Wood (TDF)	YES	WOOD	WOOD	WOOD	WOOD	8	19	1940	S-7/31/2013
RD-4283-BR1	Ash Avenue, Bridge 1	67	47	49C0320	M	Off	0.070	35° 26' 58.228	120° 53' 10.924	REINF CONCRETE	REINFORCED CONCRETE		REINF CONC	REINF CONC	REINF CONC	STEEL	3	26.0	1990	S-3/21/2000
RD-4061-BR1	Asuncion Rd., Bridge 1	26.5	32	49C0169	M	Off	0.220	35° 25' 50.713	120° 36' 12.961	Bridge Structure	REINFORCED CONCRETE		REINF CONC		REINF CONC		2	12	1969	S-7/8/2010
RD-2070-BR1	Avila Beach Drive, Bridge 1	478.9	37.7	49C0327	A	On	1.138	35° 10' 46.08	120° 44' 15.91	REINF CONCRETE	REINFORCED CONCRETE		REINF CONC	REINF CONC	REINF CONC		8	59	1967	S-12/9/2008
RD-2020-BR1	Branch Mill Rd., Bridge 1	12	22	N/A	C	Off	0.200			WOOD BEAMS	REINF. CONC.		REINF CONC	REINF CONC			1	10.5		C-11/06/2012
RD-2020-BR2	Branch Mill Rd., Bridge 2	88	24	49C0143	C	Off	1.110	35° 7' 55.01	120° 32' 34.19	STEEL TRUSS	REINFORCED CONCRETE		REINF CONC	S.Truss	REINF CONC	REINF CONC	3	37.5	1949	S-7/31/2013
RD-2089-BR2	Buckley Rd., Bridge 2	83	28	49C0106	A	On	1.600	35° 14' 9.08	120° 39' 29.21	CONCRETE	REINFORCED CONCRETE		REINF CONC	STEEL		REINF CONC	3	39.5	1956	S-7/9/2007
RD-2089-BR1	Buckley Rd., Bridge 1	26	29	49C0105	A	Off	0.730	35° 14' 8.57	120° 40' 29.42	CONCRETE	REINFORCED CONCRETE		REINF CONC	REINF CONC			1	22	1915	S-4/26/2013
RD-2089-BR3	Buckley Road, Bridge 3	33	28	49C0379	A	Off	1.638	35° 14' 9.15	120° 39' 27.67	REINF CONCRETE	REINFORCED CONCRETE		REINF CONC				1	30	1978	S-7/31/2013
RD-5092-BR1	Burton Drive, Bridge 1	123	35.4	49C0097	M	Off	0.169	35° 33' 53.64	121° 04' 54.913	CONCRETE	REINFORCED CONCRETE		REINF CONC	REINF CONC	REINF CONC		3	48	1968	S-5/5/2012
RD-3123-BR2	Canet Road, Bridge 1	25.6	16	49C0429	M	On	0.300	35° 21' 11.53"	120° 47' 19.63"	DBL. BOX CULVERT	REINF CONCRETE		REINF CONC	REINF CONC	REINF CONC		2			S-11/10/2012
RD-4288-BR1	Cayucos Creek Rd., Bridge 1	21.7	20	49C0247	M	Off	2.555	35° 27' 10.847	120° 54' 23.660	CONCRETE	REINFORCED CONCRETE		REINF CONC	REINF CONC			1	20	1928	S-9/29/2008
RD-1394-BR1	Century Lane, Bridge 1	76	27	49C0425	M	Off	0.030	35° 6' 10.68	120° 34' 42.68	REINF CONC.	AC over Concrete						6	9.84	1996	S-2/22/2011
RD-5264-BR1	Chimney Rock Rd., Bridge 1	213	24	49C0319	C	On	2.384	35° 40' 52.243	120° 56' 24.258	CONCRETE	REINFORCED CONCRETE		REINF CONC	STEEL		STEEL	5	60.1	1959	S-5/5/2012
RD-5285-BR1	Cholame Valley Rd., Bridge 1	78.7	20	49C0070	C	Off	1.310	35° 45' 04.621	120° 17' 46.518	CONCRETE	REINFORCED CONCRETE		REINF CONC	REINF CONC		WOOD	4	19	1948	S-7/6/2009
RD-2067-BR1	Cloverridge Lane, Bridge 1	14		49C0080	M	Off	0.159			CONC BOX CULVERT	REINFORCED CONC		REINF CONC				1	12	1947	C-3/4/2013
RD-2014-BR2	Corbett Canyon Rd., Bridge 2	23	25.6	49C0155	C	On	6.831	35° 11' 11.94	120° 34' 44.10	WOOD	AC over WOOD		ROCK	WOOD	REINF CONC	REINF CONC	2	11.15	1938	S-7/31/2013
RD-4205-BR1	Cottontail Creek Road, Bridge 1	32.8	18	49C0246	M	Off	2.662	35° 29' 16.838	120° 53' 06.531	WOOD	WOOD		WOOD	WOOD		WOOD	2	15.7	1940	S-5/6/2012
RD-4067-BR1	Creston Road, Bridge 1	21	24	49C0062	C	On	6.436	35° 34' 23.311	120° 36' 25.111	CONCRETE	REINFORCED CONCRETE		REINF CONC	WOOD			1	19	1940	C-7/05/2012
RD-4067-BR2	Creston Road, Bridge 2	182.6	30	49C0063	C	On	2.901	35° 34' 15.231	120° 32' 41.517	CONCRETE	REINFORCED CONCRETE		REINF CONC			REINF CONC	6	30	1960	S-7/8/2010
RD-5265-BR1	Cypress Mountain Dr., Bridge 1	57	17	49C0017	C	Off	6.986	35° 37' 41.092	120° 53' 55.918	Concrete/Wood	REINFORCED CONCRETE		REINF CONC	WD 45-6X16X20'		WOOD	3	18	1950	S-7/8/2010
RD-5265-BS2	Cypress Mountain Dr., Bridge 2	22.3	27.5	49C0468	C	Off	8.080	35° 38' 12.037	120° 54' 54.990	DBL. BOX CULVERT	Concrete		REINF CONC				2	9.5	1996	S-6/19/2013
RD-5265-BR3	Cypress Mtn. Rd., Bridge 3	28.6	15.4	49C0033	M	Off	5.080	35° 37' 01.144	120° 54' 54.414	WOOD	WOOD 4X12X20		ROCK	WD 6X16X20'			1	28.6	1953	S-5/5/2012
RD-5265-BR4	Cypress Mtn. Rd., Bridge 4	29	14	49C0032	M	Off	5.310	35° 37' 07.152	120° 54' 42.846	WOOD	WOOD 4X12X20		ROCK	WD 6X16X20'			1	27	1953	S-5/5/2012
RD-1065-BR2	Dana Foothill, Bridge 2	20	20	49C0134	M	Off	3.042	35° 3' 46.53	120° 28' 20.71	WD 20 6X12X20 STRING	WOOD 21 4X12X20	Yes		WOOD			1	17.3	2012	C-6/19/2012
RD-2311-BR1	Davenport Creek Road, Bridge 1	84	24	49C0152	M	Off	0.446	35° 13' 17.93	120° 38' 52.24	CONCRETE	REINFORCED CONCRETE		REINF CONC	Wood			4	21	1959	S-4/26/2013
RD-5154-BR1	Dover Canyon Rd., Bridge 1	62.3	17.4	49C0037	M	Off	1.582	35° 34' 40.47	120° 50' 05.337	STEEL TRUSS	WOOD	YES	REINF CONC	STEEL			1	60	1920	S-3/5/2012
RD-5551-BR1	East Centre Rd- BR1 - Shandon	260	30	49C0464	C	On	0.350	35° 39' 18"	120° 22' 12"	Steel Girder	REINFORCED CONCRETE		REINF CONC	STEEL	REINF CONC	NO	5	58.0	1941	S-11/01/2012-FC
RD-5189-BR1	Eddy St., Bridge 1 - Templeton	14	18.7	49C0183	M	Off	0.054	35° 33' 05.103	120° 42' 26.648	CONCRETE	AC over Concrete		REINF CONC	REINF CONC			1	12.6		C-11/08/2012
RD-3102-BR1	El Camino Real, Bridge 1	81.5	35	49C0310	C	On	8.819	35° 25' 43.355	120° 36' 20.580	CONCRETE	REINFORCED CONCRETE		REINF CONC	STEEL	STEEL		5	16	1930	S-7/8/2010
RD-1393-BR1	El Campo Rd., Bridge 1	65.0	22.3	49C0131	M	Off	2.510	35° 5' 37.49	120° 33' 44.71	WOOD	REINFORCED CONCRETE				WOOD	WOOD	3	20.3	1956	S-4/25/2013
RD-5203-BR1	EL Pomar Dr., Bridge 1	17.5	24	49C0185	C	Off	1.549	35° 33' 31.415	120° 41' 13.729	Bridge Structure	REINFORCED CONCRETE		REINF CONC				1	12		C-11/08/2012
RD-5203-BR2	EL Pomar Dr., Bridge 2	19.5	25	49C0186	C	Off	3.359	35° 33' 50.674	120° 39' 27.698	CONCRETE	REINFORCED CONCRETE		REINF CONC				1	18		C-11/08/2012
RD-5203-BR3	EL Pomar Dr., Bridge 3	19	26	49C0187	C	Off	3.705	35° 33' 45.659	120° 39' 06.331	CONCRETE	REINFORCED CONCRETE		REINF CONC				1	16		C-11/08/2012
RD-3109-BR1	Encina Ave., Bridge 1	36.1	28	49C0173	M	On	0.123	35° 23' 21.161	120° 36' 18.124	CONCRETE	REINFORCED CONCRETE		REINF CONC			REINF CONC	2	15	1984	S-7/16/2012

Object	Description	Bridge Length (ft)	Bridge Width (ft)	State Bridge Number	Road Class	Federal Aid System	Bridge Center Mile Post	Latitude at Center of Bridge	Longitude at Center of Bridge	Bridge Construction Type	Bridge Deck Covering	Load Limit Posted	Headwall/Abutment Construction	Structure Construction	Pier Construction	Piles	Number of Spans	Span Length (ft)	Year Constructed R-Rebuilt	Last Inspection Date
RD-5229-BR1	Estrella Rd., Bridge 1	59	22	49C0216	C	On	9.410	35° 43'03.959	120° 37'50.805	CONCRETE	REINFORCED CONCRETE		REINF CONC	REINF CONC	REINF CONC	STEEL	3	19	1940	S-7/6/2010
RD-5229-BR2	Estrella Rd., Bridge 2	301.8	29	49C0048	C	On	7.050	35° 42'08.996	120° 36'11.328	CONCRETE	REINFORCED CONC		REINF CONC		REINF CONC	STEEL	4	85	1978	S-5/5/2012
RD-5150-BR1	Ferrasci Road, Bridge 1	95.1	24.6	49C0455	M	Off	0.015	35° 34'5.78"	121° 03'54.06"	CONCRETE	REINFORCED CONCRETE		REINF CONC	REINF CONC		REINF CONC	1	93	2011	S-11/11/2012
RD-5179-BR1	Florence St., Bridge 1 -- Templeton	11.5	26		M	Off	0.240	35° 33' 00.731	120° 42' 35.223	WOOD	REINFORCED CONCRETE		REINF CONC	WOOD			1	11.3		C-11/08/2012
RD-3083-BR1	Foothill Blvd., Bridge 1	34	36	49C0222	A	On	0.399	35° 16' 47.74	120° 42' 34.53	Concrete box Structure	REINFORCED CONCRETE		REINF CONC	REINF CONC	REINF CONC		3	11	1959	S-8/17/2008
RD-5152-BR1	Green Valley Rd., Bridge 1 - N. branch	52.5	16	49C0291	M	Off	0.180	35° 32' 33.814	121° 00' 38.293	CONCRETE	REINFORCED CONCRETE		REINF CONC	WOOD		WOOD	3	20.8	1958	S-5/6/2012
RD-3204-BR1	H Street, Bridge 1 - Santa Margarita	32	27	49C0279	M	Off	0.428	35° 23'31.823	120° 36'14.877	CONCRETE	REINFORCED CONCRETE		REINF CONC				1	30.7	1971	S-7/8/2010
RD-2034-BR2	Hi Mountain Rd., Bridge 2	46	20	49C00122	M	Off	4.990	35°12' 12.39	120° 25' 17.62	WOOD	WOOD		WOOD	WOOD	WOOD	WOOD	3	15	1966	S-7/31/2013
RD-2034-BR1	Hi Mountain Rd., Bridge 1	57	25	49C0121	M	Off	2.782	35° 11' 24.13	120° 26' 3.90	CONCRETE	REINFORCED CONCRETE		REINF CONC	REINF CONC			1	55	1965	S-5/3/2011
RD-2092-BR1	Higuera Street, Bridge 1	267	29	49C0396	C	On	1.060	35° 53' .32	120° 41' 22.01	CONCRETE	REINFORCED CONCRETE						7	38	1928	S-4/26/2013
RD-5518-BR1	Hog Canyon Rd., Bridge 1	39.4	19	49C0215	M	Off	6.180	35° 43'55.018	120° 34'10.414	CONCRETE	REINFORCED CONCRETE		CONCRETE		Concrete		2	19	1960	S-7/16/2012
RD-2023-BR0	Huasna Rd. Bridge 0	45	21.32	49C0124	C	On	0.860	35° 8' 21.40	120° 32' 48.72	REINF CONC	REINFORCED CONCRETE		REINF CONC	REINF CONC	REINF CONC		1	42	1923	S-7/31/2013
RD-2023-BR1	Huasna Rd., Bridge 1	12.0	23.5	49C0144	C	On	2.250	35° 8' 12.51??	120° 35.55??	CONCRETE-BOX	CONCRETE		REINF CONC			unknown	1	12		C-6/14/2012
RD-2023-BR2	Huasna Rd., Bridge 2	14	25.5	49C0275	C	On	3.500	35° 8' 9.80	120°30' 50.01	CONCRETE	REINFORCED CONCRETE		REINF CONC	Bridge Structure			1	12		C-6/14/2012
RD-2023-BR3	Huasna Rd., Bridge 3	16	23	49C0145	C	On	4.810	35° 8' 3.61	120° 30' 22.14	CONCRETE	REINFORCED CONC		REINF CONC				1	16.5		C-6/14/2012
RD-2023-BR4	Huasna Rd., Bridge 4	12	21		C	On	7.160	35° 8' 1.73	120° 27' 8.34	CONCRETE	REINFORCED CONCRETE		REINF CONC				1	12		C-6/14/2012
RD-2023-BR5	Huasna Rd., Bridge 5	26.	21	49C0146	C	On	10.960	35° 7' 20.63	120° 23' 46.25	REINF CONC	REINFORCED CONCRETE		REINF CONC	REINF CONC			1	23	1930	S-7/31/2013
RD-1071-BR1	Huasna Townsite Rd., Bridge 1	173.5	12.8	49C0147	M	Off	0.008	35° 5' 12.61	120° 22' 9.92	WOOD	WOOD	Yes	WOOD	WOOD	WOOD	WOOD	9	21	1965	S-7/31/2013
RD-1514-BR1	Hutton Rd., Bridge 1	404	28.2	49C0404	A	On	0.691	35° 0' 10.64	120° 26' 22.19	REINF CONC.	REINFORCED CONCRETE		REINF CONC	REINF CONC	REINF CONC	REINF CONC	3	40	1957	S-10/18/2012
RD-3206-BR1	I Street, Bridge 1-- Santa Margarita	39.4	30	49C0172	M	On	0.814	35° 23'27.575	120° 36'13.952	REINF CONCRETE	REINFORCED CONCRETE		REINF CONC		REINF CONC		3	11.8	1950	S-7/8/2010
RD-6041-BR1	Indian Valley Rd., Bridge 1	110	28.5	49C0210	C	Off	1.894	35° 46'41.282	120° 46'59.881	CONCRETE	REINFORCED CONCRETE		REINF CONC		REINF CONC	STEEL	3	36	1980	S-7/16/2012
RD-5292-BR1	Jack Creek Rd., Bridge 1	204.6	26	49C0342	M	Off	0.072	35° 32' 54.623	120° 47' 34.492	STEEL	REINFORCED CONCRETE		REINF CONC	STEEL	REINF CONC	WOOD	11	19	1938	S-7/18/2012
RD-2064-BR1	Jesperson Rd., Bridge 1	94	18	49C0322	M	Off	1.148	35° 14' 3.18	120° 40' 0.71	WOOD	WOOD 97-4X12X20		REINF CONC	WD 48-6X16X20'		WOOD 15	4	23	1959	S-4/26/2013
RD-5153-BR5	Klau Mine Rd., Bridge 5	31	24.3	49C0029	C	Off	0.185	35° 37' 30.773	120° 53' 37.314	CONCRETE	REINFORCED CONCRETE		REINF CONC	REINF CONC			1	27.9	1940	S-5/5/2012
RD-1096-BR1	Lakeside Ave., Oceano- Bridge 1	144.3	20	49C0126	M	Off	0.236	35° 6' 15.92	120° 37' 38.79	WOOD	WOOD		REINF CONC	WOOD		WOOD	8	19	1940	S-10/19/2012
RD-3100-BR2	Las Pilitas Rd., Bridge 2	28	19	49C0191	M	Off	2.301	35° 20'58.226	120° 30'07.465	CONCRETE	REINFORCED CONCRETE		REINF CONC	STEEL		REINF CONC	2	14.5	1930	S-7/8/2010
RD-3100-BR3	Las Pilitas Rd., Bridge 3	28	18.4	49C0192	M	Off	3.688	35° 21'29.741	120° 28'54.716	CONCRETE	REINFORCED CONCRETE		REINF CONC	STEEL	REINF CONC		2	11.5	1930	S-7/8/2010
RD-3100-BR4	Las Pilitas Rd., Bridge 4	14	18		M	Off	4.940	35° 21'51.615	120° 27'47.729	CONCRETE	REINFORCED CONCRETE		REINF CONC				1	16		C-10/16/2012
RD-3100-BR5	Las Pilitas Rd., Bridge 5	250	25	49C0435	M	Off	1.600	35° 20'53.660	120° 30'47.868	CONCRETE	REINFORCED CONCRETE		REINF CONC	REINF CONC	REINF CONC	STEEL	2	125	2006	S-7/9/2009
RD-5163-BR1	Las Tablas Rd., Bridge 1	12	24	49C184	C	Off	0.070	35° 33' 14.551	120° 42' 14.168	CONCRETE	REINFORCED CONCRETE		REINF CONC	REINF CONC			1	12	1977	C-11/08/2012
RD-4405-BR1	Linden Ave., Bridge 1	71	22	49C0171	M	Off	0.035	35° 24'44.378	120° 36'21.295	CONCRETE	REINFORCED CONCRETE		REINF CONC	WOOD		WOOD 10	3	23	1955	S-7/8/2010
RD-5232-BR1	Linne Road, Bridge 1	205	28.5	49C0420	M	Off	3.166	35° 36'03.298	120° 36'12.222	CONCRETE	REINFORCED CONCRETE		REINF CONC	REINF CONC		STEEL	1	40	1996	S-2/24/2011
RD-2019-BR1	Lopez Drive, Bridge 1	71.8	34.1	49C0353	C	On	8.728	35° 11' 18.41	120° 29' 22.54	PC-PS Conc I Girders	REINFORCED CONCRETE		REINF CONC				1	65.28	1968	S-7/31/2013
RD-2019-BR2	Lopez Drive, Bridge 2	316.8	34.1	49C0354	C	On	13.006	35° 11' 15.26	120° 27' 29.58	PC-PS Conc I Girders	REINFORCED CONCRETE		REINF CONC	REINF CONC	REINF CONC	STEEL	3	103	1968	S-5/3/2011
RD-2088-BR1	Los Osos Valley Rd., Bridge 1	86.6	76.8	49C0238	A	On	3.787	35° 18' 21.42	120° 48' 42.28	REINF CONCRETE	REINFORCED CONCRETE		REINF CONC	STEEL	REINF CONC	STEEL	3	28	1991	S-5/6/2012
RD-5186-BR2	Main St., Bridge 2 - Templeton	22	57.4	49C0403	A	On	0.300	35° 33' 40.532	120° 42' 02.129	DBL. BOX CULVERT	REINFORCED CONCRETE		REINF CONC			REINF CONC	2	10	1929	S-8/30/2006
RD-5145-BR1	Main Street, Bridge 1 -- Cambria	91.8	23	49C0337	A	On	1.070	35° 33' 56.953	120° 04' 28.803	CONCRETE	REINFORCED CONCRETE		REINF CONC	REINF CONC	REINF CONC		2	45	1922	S-5/5/2012
RD-5186-BR1	Main Street, Bridge 1 -- Templeton	27	49.3	49C0402	A	On	0.300	35° 33' 43.415	120° 42' 01.718	DBL. BOX CULVERT	REINFORCED CONCRETE		REINF CONC		REINF CONC		3	8	1929	S-7/17/2012
RD-1062-BS1	Melschau Rd., BRIDGE 1	15	18	49C0132	M	Off	0.850	35°° 3' 38.35°°	120° 28' 32.45	CONCRETE	REINFORCED CONCRETE		REINF CONC	REINF CONC			1	13	1962	C-6/19/2012
RD-2065-BR1	Monte Rd., Bridge 1	32.6	18	49C0261	M	Off	0.910	35° 11' 33.38	120° 41' 34.78	WOOD	WOOD 4 X 12 X 18	Yes	REINF CONC	WOOD		4	2	15.8	1958	S-7/7/2009

Object	Description	Bridge Length (ft)	Bridge Width (ft)	State Bridge Number	Road Class	Federal Aid System	Bridge Center Mile Post	Latitude at Center of Bridge	Longitude at Center of Bridge	Bridge Construction Type	Bridge Deck Covering	Load Limit Posted	Headwall/Abutment Construction	Structure Construction	Pier Construction	Piles	Number of Spans	Span Length (ft)	Year Constructed R-Rebuilt	Last Inspection Date
RD-5128-BR1	Moonstone Beach Dr., Bridge 1	295	43.3	49C0448	C	On	1.350	35° 34' 53.64	121° 07' 9.12	CONCRETE	REINFORCED CONCRETE		REINF CONC	REINF CONC	REINF CONC	REINF CONC	3	131.2	2011	S-4/26/2013
RD-2037-BR1	Morretti Canyon Rd., Bridge 1	18	16	49C0386	M	Off	0.920	35° 13' 9.86	120° 34' 34.33	CONCRETE	REINFORCED CONCRETE	Yes	ROCK	WOOD			1	17		C-11/06/2012
RD-2037-BR2	Morretti Canyon Rd., Bridge 2	18	16	49C0387	M	Off	1.883	35° 13' 15.95	120° 34' 21.42	WOOD	WOOD	Yes	ROCK	WOOD			1	17		C-11/06/2012
RD-2037-BR3	Morretti Canyon Rd., Bridge 3	19	18	49C0111	M	Off	2.512	35° 13' 27.61	120° 34' 1.68	WOOD	WOOD	Yes	ROCK	WOOD			1	16		C-11/06/2012
RD-2037-BR4	Morretti Canyon Rd., Bridge 4	18	18	49C0202	M	Off	4.038	35° 14' 3.44	120° 33' 24.20	WOOD	WOOD	Yes	ROCK	WOOD			1	16.7		C-11/06/2012
RD-2037-BS1	Morretti Canyon Rd., Struct. 1	8	16		M	Off	3.485	35° 13' 52.93	120° 33' 40.49	WOOD	WOOD		ROCK	WOOD			1	6.7		C-11/06/2012
RD-5218-BR1	N. Bitterwater Rd., Bridge 1	138.0	32.8	49C0073	C	On	0.333	35 42'35.237	120 18'17.492	CONCRETE	REINFORCED CONCRETE		REINF CONC	REINF CONC	REINF CONC	STEEL	3	60	1979	S-8/4/2011
RD-5277-BR1	Nacimiento Lake Dr., Bridge 1	59	36	49C0355	C	On	5.528	35 41'17.223	120 45'47.777	Triple Box Culvert	AC over Concrete		REINF CONC		REINF CONC		3	18	1964	S-7/18/2012
RD-4309-BR1	Norte Rd., Bridge 1	23	16	49C0278	M	Off	0.003	35 25'07.5	120 36'29.711	WOOD	WOOD		WOOD	WOOD	WOOD	WOOD	1	19.7	1956	S-10/19/2012
RD-4256-BR1	North Ocean Ave., Bridge 1	192	36	49C0341	A	Off	1.080	35° 27' 00.057	120° 54' 25.644	CONCRETE	REINFORCED CONCRETE		REINF CONC		REINF CONC		7	29.7	1951	S-10/1/2008
RD-4217-BR1	Ocean Blvd., Bridge 1	26.2	21	49C0335	M	Off	0.564	35° 25' 42.678	120° 52' 52.080	CONCRETE	REINFORCED CONCRETE		REINF CONC	REINF CONC			1	70	1925	S-7/8/2010
RD-4072-BR3	O'Donovan Rd., Bridge 3	168	30	49C0427	C	Off	5.300	35 31'04.434	120 31'17.723	CONCRETE	REINFORCED CONCRETE		CONCRETE	REINF CONC	REINF CONC	STEEL	4	42	1999	S-5/4/2011
RD-4072-BR1	O'Donovan Road, Bridge 1	14.0	36		C	Off	0.072	35 27'07.505	120 28'47.954	DBL. BOX CULVERT	AC over Concrete		ROCK		ROCK		2	6	1996	C-7/05/2012
RD-4072-BR2	O'Donovan Road, Bridge 2	37.4	25	49C0282	C	Off	0.750	35 27'26.192	120 29'23.323	CONCRETE	REINFORCED CONCRETE		ROCK		ROCK		2	18	1974	S-5/6/2012
RD-4293-BR1	Old Creamery Rd., Bridge 1-- Harmony	29.9	50	49C0207	M	Off	0.120	35° 30' 32.193	120° 01' 24.751	CONCRETE	REINFORCED CONCRETE		REINF CONC	REINF CONC	Concrete arch		1	29.9	1906	S-9/29/2008
RD-4004-BR1	Old Morro Road West, Bridge No. 1	15.0	30.4	49C374	M	Off	0.150	35 27'31.190	120 44'10.356	CONCRETE	CONCRETE		CONCRETE	CONCRETE			1	12	1986	C-5/16/2012
RD-2066-BR1	Ontario Rd., Bridge 1	720.6	30.5	49C0410	M	Off	0.363	35° 35' 11' 2.76	120° 42' 12.56	CONCRETE	REINFORCED CONCRETE		REINF CONC	REINF CONC	REINF CONC	STEEL	15	80	1994	S-10/18/2012
RD-2039-BR1	Orcutt Rd., Bridge 1	34	26	49C0113	C	On	3.08??	35° 13' 3.33	120° 35' 44.62	CONCRETE	REINFORCED CONCRETE		Concrete				1	31	1949	S-7/31/2013
RD-2039-S7	Orcutt Rd., Structure 7	12	26		C	On	0.980			8x10 Conc Box Culvert	AC over Concrete		CONC.-ROCK				1	12		C-5/02/2012
RD-2039-S8	Orcutt Rd., Structure 8	18	54		C	On	3.790			Dbl. 8x8 Conc Box	AC over fill		Dbl-8x8RC Box				2	8	1970	C-5/02/2012
RD-2039-S9	Orcutt Rd., Structure 9	16	72		C	On	4.570			Concrete slab	AC over Concrete		PCC Slab				1	14		C-5/02/2012
RD-2010-BR3	Ormonde Rd., Bridge 3	137.8	28.5	49C0112	C	Off	0.030	35°10' 38.62	120° 37' 12.57	CONCRETE	REINFORCED CONCRETE		REINF CONC	REINF CONC	REINF CONC	STEEL	3	60	1978	S-4/26/2013
RD-3092-BR2	Park Hill Rd., Bridge 2	41	23	49C0194	C	Off	18.380	35 18'45.152	120 21'27.373	CONCRETE	REINFORCED CONCRETE		REINF CONC	STEEL			1	43	1956	S-7/16/2012
RD-2306-BR2	Pecho Rd., Bridge 2	45.9	28.9	49C0239	C	On	0.010	35° 16' 29.39	120° 53' 11.91	CONCRETE	REINFORCED CONCRETE		REINF CONC				1	42.5	1974	S-5/6/2012
RD-4296-BR1	Picachio Rd., Bridge 1	63	25.5	49C0443	M	Off	0.010	35° 28' 25.552	120° 54' 46.880	PC-PS Conc Box Girders	REINFORCED CONCRETE		REINF CONC	REINF CONC		CONCRETE	1	55	2007	S/10/16/2008
RD-4296-BR2	Picachio Rd., Bridge 2	44	17	49C0385	M	Off	0.978	35° 28' 55.435°	120° 55' 26.140	WOOD	WD 42 4X12X18 BOARDS		WOOD	WD 24-6X16X23'		WOOD	2	21	1960	S-7/18/2012
RD-1095-BR1	Pier Ave., Oceano - Bridge 1	63	58	49C0414	C	On	0.273	35° 6' 22.84	120° 37' 33.65	CONCRETE	REINFORCED CONCRETE		REINF CONC		Conc Piles	REINF CONC	3	24	1994	S-10/18/2012
RD-2086-BR1	Pippin Lane, Bridge 1	26	20	49C0391	M	Off	0.103	35° 12' 34.07	120° 43' 10.73	WOOD	WOOD 17-3X12X23		WOOD 3X12	CAPS 12X12-18'		8 PILES	1	26.9	1950	S-4/25/2013
RD-3089-BR1	Pozo Rd., Bridge 1	82	30.5	49C0302	C	Off	3.491	35 21'11.149	120 32'18.40	CONCRETE	REINFORCED CONCRETE		REINF CONC	REINF CONC		REINF CONC	3	24	1959	S-7/8/2010
RD-3089-BR2	Pozo Rd., Bridge 2	59	22	49C0303	C	On	14.071	35 17'55.156	120 24'19.623	WOOD	CORRUG STL WITH AC		REINF CONC	WOOD		WOOD	3	19	1941	S-7/17/2012
RD-3089-BR3	Pozo Rd., Bridge 3	239.4	28	49C0304	C	On	14.161	35 17'55.709	120 24'13.924	WOOD	WOOD		REINF CONC	STEEL		WOOD	6	121.8	1989	S-8/2/2004
RD-3089-BR4	Pozo Rd., Bridge 4	72	32	49C0305	C	On	15.829	35 18'13.157	120 22'37.028	CONCRETE	REINFORCED CONCRETE		REINF CONC		REINFORCED CONCRETE		3	28	1970	S-7/8/2010
RD-3089-BR5	Pozo Road, Bridge 5	20	21	49C0306	C	On	19.937	35 19'08.659	120 18'53.412	CONCRETE	CONCRETE		REINF CONC				1	19		C-10/30/2012
RD-2084-BR2	Prefumo Canyon Rd., Bridge 2	38	41	49C0228	C	Off	5.963	35° 15' 56.48	120° 43' 58.70	CONCRETE	REINFORCED CONCRETE		REINF CONC				1	35.8	1974	S-7/6/2009
RD-2084-BR3	Prefumo Cyn. Rd., Bridge 3	49	41	49C0227	C	Off	6.716	35° 15' 48.90	120° 43' 35.42	CONCRETE	REINFORCED CONCRETE		REINF CONC				1	43	1974	S-12/9/2008
RD-2084-BR4	Prefumo Cyn. Rd., Bridge 4	29.5	28	49C0226	C	Off	6.925	35° 15' 47.37	120° 43' 28.55	CONCRETE	REINFORCED CONCRETE		REINF CONC		REINF CONC		2	12	1969	S-12/9/2008
RD-2001-BR3	Price Canyon Rd., Bridge 3	151	32.5	49C0330	C	On	6.614	35° 11' 53.71	120° 36' 39.31	CONCRETE	REINFORCED CONCRETE		REINF CONC	REINF CONC	PCC Piles	REINF CONC	3	60	1963	S-4/26/2013
RD-2001-BR2	Price Cyn. Rd., Bridge 2	133.8	32.8	49C0329	C	On	6.382	35° 11' 47.28	120° 36' 44.20	CONCRETE	REINFORCED CONCRETE		REINF CONC	REINF CONC	REINF CONC		3	44	1963	S-4/26/2013
RD-8324-BR1	Quailwood Road - Bridge 1										REINFORCED CONCRETE		REINF CONC	REINF CONC		?	1	37		
RD-6052-BR4	Ranchita Canyon Rd., Bridge 4	42.6	24.6	49C0419	M	Off	2.900	35 46'53.661	120 35'22.077	CONCRETE	REINFORCED CONCRETE		REINF CONC		RC	STEEL	1	42.6	1997	S-7/7/2010

Object	Description	Bridge Length (ft)	Bridge Width (ft)	State Bridge Number	Road Class	Federal Aid System	Bridge Center Mile Post	Latitude at Center of Bridge	Longitude at Center of Bridge	Bridge Construction Type	Bridge Deck Covering	Load Limit Posted	Headwall/Abutment Construction	Structure Construction	Pier Construction	Piles	Number of Spans	Span Length (ft)	Year Constructed R-Rebuilt	Last Inspection Date
RD-6052-BR1	Ranchita Canyon Rd., Bridge 1	67.9	29.9	49C0416	M	Off	0.052	35 44'49.976	120 36'46.458	CONCRETE	REINFORCED CONCRETE		REINF CONC		RC	STEEL	3	25.9	1996	S-7/7/2010
RD-6052-BR2	Ranchita Canyon Rd., Bridge 2	62.3	24.6	49C0417	M	Off	1.799	35 46'05.938	120 35'56.873	CONCRETE	REINFORCED CONCRETE		REINF CONC		RC	STEEL	1	62.3	1997	S-7/7/2010
RD-6052-BR3	Ranchita Canyon Rd., Bridge 3	62.3	24.6	49C0418	M	Off	2.274	35 46'23.888	120 35'37.659	CONCRETE	REINFORCED CONCRETE		REINF CONC		RC	STEEL	1	62.3	1997	S-7/7/2010
RD-2038-BR1	Reggetti Rd., Bridge 1	16	18		M	Off	0.710	35° 14' 4.45	120° 35' 29.49	WOOD	WOOD		Concrete				1	16.5	1949	C-11/06/2012
RD-3118-BR1	Reservoir Canyon Rd., Bridge 1	60	24.6	49C0421	M	Off	0.134	35 17'40.502	120 37'47.589	CONCRETE	REINFORCED CONCRETE		REINF CONC	REINF CONC		REINF CONC	1	63	1998	S-7/7/2010
RD-5286-BR1	River Grove Dr., Bridge 1	160	25	49C0307	M	Off	0.148	35 39'11.056	120 30'28.439	CONCRETE	REINFORCED CONCRETE	Yes	REINF CONC	STEEL			1	153.8	1910	S-5/5/2012
RD-3091-BR1	River Rd., Bridge 1	18	21		M	Off	1.259	35 18'50.894	120 24'39.145	CONCRETE	REINFORCED CONCRETE		REINF CONC				1	18		C-10/30/2012
RD-5252-BR1	River Rd., Bridge 1-- San Miguel	97	22	49C0052	A	Off	3.430	35 40'29.772	120 41'12.171	CONCRETE	REINFORCED CONCRETE		WOOD	WOOD		WOOD	6	19	1950	S-7/6/2010
RD-3091-BR2	River Rd., Bridge 2	57.5	26	49C0259	M	Off	2.415	35 19'27.550	120 25'16.034	CONCRETE	REINFORCED CONCRETE		REINF CONC	REINF CONC	REINF CONC	STEEL	3	16.5	1986	S-7/17/2012
RD-5252-BR2	River Rd., Bridge 2 -- San Miguel	116	22.3	49C0346	A	On	3.500	35 40'31.470	120 41'11.214	CONCRETE	REINFORCED CONCRETE		WOOD	WOOD		WOOD	5	19	1965	S-7/7/2009
RD-5252-BR3	River Rd., Bridge 3 -- San Miguel	1106.3	34.8	49C0444	A	Off	9.420	35 45'12.038	120 41'16.318	CONCRETE	REINFORCED CONCRETE		REINF CONC		PCC Columns	REINF CONC	8	142	2005	S-7/17/2012
RD-2068-BR1	San Luis Bay Drive, Bridge 1	105	27	49C0328	M	Off	1.635	35° 11' 44.96	120° 41' 49.11	CONCRETE	CONC. WITH AC ON TOP		CONCRETE		CONCRETE		3	40	1964	S-10/19/2012
RD-2068-BR2	San Luis Bay Drive, Bridge 2	32.1	28	49C0150	A	On	0.661	35° 11' 39.90	120° 42' 49.03	CONCRETE							2	14.75	1940	S-4/25/2013
RD-2068-BR3	San Luis Bay Drive, Bridge 3	214	43	49C0438	A	On	1.640	35° 11' 17.88	120° 43' 7.81								2	108.25	2009	S-4/25/2013
RD-3210-BR1	San Luisito Creek Rd., Bridge 1	51.6	22	49C0235	M	Off	0.342	35° 21' 25.91	120° 46' 57.42	CONCRETE	Concrete			Wood			3	19	1957	S-7/7/2009
RD-5267-BR4	San Simeon Creek Rd. Bridge 4	77	18	49C0103	M	Off	5.468	35° 37' 38.254	121° 03' 12.569	CONCRETE	REINFORCED CONCRETE		REINF CONC	WD 6X16X20'	REINF CONC		3	24	1964	S-9/29/2008
RD-5267-BR1	San Simeon Creek Rd., Bridge 1	149.6	26.6	49C0437	M	Off	2.343	35° 36' 26.835	121° 05' 26.421	PC-PS Conc Box Girders	REINFORCED CONCRETE		REINF CONC	REINF CONC	REINF CONC	CIDH-Conc	1	139.7	2011	S-11/10/2012
RD-5267-BR2	San Simeon Creek Rd., Bridge 2	138.1	26.9	49C0436	M	Off	3.526	35° 36' 34.451	121° 04' 33.573	PC-PS Conc Box Girders	REINFORCED CONCRETE		REINF CONC	REINF CONC	REINF CONC	CIDH-Conc	3	55.1	2011	S-11/11/2012
RD-5267-BR3	San Simeon Creek Rd., Bridge 3	20	18	49C0102	M	Off	4.600	35° 37' 03.981	121° 04' 03.337	WOOD	WOOD 19- 4X12X20		REINF CONC	WD 13-6X16X20'			1	19	1971	C-11/15/2012
RD-4204-BR1	Santa Rita Rd., Bridge 1	105	22	49C0093	C	Off	0.274	35° 28' 20.302	120° 51' 07.626	CONCRETE	REINFORCED CONCRETE		REINF CONC	WOOD	WOOD		6	13.3	1940	S-9/28/2008
RD-4204-BR3	Santa Rita Rd., Bridge 3	145.5	27	49C0348	M	Off	13.993	35° 31' 18.982	120° 48' 03.258	CONCRETE T-Beams	REINFORCED CONCRETE		REINF CONC		REINF CONC		3	54.3	1971	S-7/18/2012
RD-5086-BR2	Santa Rosa Creek Rd., Bridge 2	10	42		C	Off	1.650			Concrete Box Culvert	AC over Concrete		REINF CONC				1	8		C-5/11/2012
RD-5086-BR3	Santa Rosa Creek Rd., Bridge 3	10	19		C	Off	2.700	Didn't find	Didn't find	10' Conc Arch	AC over Concrete		ROCK-Conc				1	10	1905	C-5/11/2012
RD-5086-BR4	Santa Rosa Creek Rd., Bridge 4	20	24.5	49C0343	C	Off	5.560	35° 34' 29.954	120° 59' 31.332	CONCRETE	AC over Concrete		ROCK-Conc				1	18	1948	C-5/11/2012
RD-5086-BR5	Santa Rosa Creek Rd., Bridge 5	33	31	49C0344	C	Off	9.330	35° 33' 46.108	120° 56' 36.943	CONCRETE	AC over Concrete		REINF CONC	spread footing			1	30.8	1947	S-5/5/2012
RD-5086-BR6	Santa Rosa Creek Rd., Bridge 6	20.3	35.1	49C0392	C	Off	9.900	35° 34' 01.377	120° 56' 20.844	DBL. BOX CULVERT	AC over Concrete		REINF CONC		REINF CONC		2	8		C-5/11/2012
RD-5086-BR7	Santa Rosa Creek Rd., Bridge 7	39.4	27	49C0345	C	Off	15.268	35° 32' 39.649	120° 52' 01.696	CONCRETE	REINFORCED CONCRETE		REINF CONC				1	36	1948	S-5/5/2012
RD-5155-BR1	Shadow Canyon Rd., Bridge 1	20.7	22.2	49C0181	M	Off	0.010	35° 32' 31.397	120° 49' 07.395	CONCRETE	REINFORCED CONCRETE		REINF CONC	WOOD			1	19.75	1940 - 1986	C-11/08/2012
RD-5155-BR2	Shadow Canyon Rd., Bridge 2	13.7	14		M	Off	0.800	35° 32' 57.930	120° 49' 42.965	WOOD	WOOD		REINF CONC	WOOD			1	12	???	C-11/08/2012
RD-1521-BR1	Sheehy Rd., BR1	17.75	25.7		M	Off	0.381	35° 4' 24.23	120° 30' 7.21	Concr. Br Struct	REINFORCED CONCRETE						1	11.75	1984	C-12/21/2012
RD-5274-BR1	SLO San Simeon Rd., Bridge 1	50.5	20.3	49C0254	M	Off	0.211	35° 38' 38.656	121° 11' 20.59	CONCRETE	REINFORCED CONCRETE		REINF CONC	REINF CONC			1	47.9	1916	S-9/29/2008
RD-1152-BR1	Soda Lake Rd., Bridge 1	36.1	32	49C0411	C	On	1.500			Concrete	AC over Concrete						3	11.7	1987	S-5/5/2012
RD-3125-BR1	South Bay Blvd., Bridge 1	190.2	33	49C0351	A	Off	2.912	35° 20' 6.25	120° 49' 23.18	CONCRETE	REINFORCED CONCRETE		REINF CONC	REINF CONC		REINF CONC	3	62.7	1966	S-8/30/2006
RD-3117-BR1	Stagecoach Rd., Bridge 1	15	30		M	On	0.147	35 19'08.840	120 37'19.010	CONCRETE	REINFORCED CONCRETE		REINF CONC-Arch				1	12	1930	C-8/02/2012
RD-3085-BR1	Stenner Creek Rd., Bridge 1	38.8	27	49C0084	M	Off	0.041	35° 18' 29.44	120° 40' 50.04	CONCRETE	REINFORCED CONCRETE		REINF CONC		REINF CONC		3	12	1959	S-5/4/2011
RD-3085-BR2	Stenner Creek Rd., Bridge 2	40.6	12	49C0085	M	Off	2.142	35° 19' 27.75	120° 40' 29.90	WOOD	WOOD		REINF CONC	STEEL			1	37	1970	S-5/4/2011
RD-1069-BR1	Suey Creek Rd., Bridge 1	20	15.33	49C0276	M	On	1.676	35° 1' 31.92	120° 22' 1.24	WD-12 6X16X20 STRING	WOOD- 16 4X12X20	Yes	REINF CONC	WOOD			1	17.5		C-8/22/2012
RD-1069-BR2	Suey Creek Rd., Bridge 2	16	20	49C0360	M	On	3.637	35° 2' 50.50	120° 23' 4.30	WOOD	WOOD-WITH AC ON TOP		REINF CONC	WD 13 6X8X16'			1	15		C-8/22/2012
RD-3120-BR1	Tassajara Creek Rd., Bridge 1	33.8	16	49C0281	M	Off	0.028	35 22'14.397	120 38'30.006	Wood	Wood		REINF CONC	STEEL			1	32.2	1940	S-7/18/2012
RD-3120-BR2	Tassajara Creek Rd., Bridge 2	26.9	13.8	49C0333	M	Off	2.066	35 22'59.123	120 40'17.544	WOOD	WOOD	Yes	REINF CONC	WOOD			1	25	1960	S-7/18/2012

Object	Description	Bridge Length (ft)	Bridge Width (ft)	State Bridge Number	Road Class	Federal Aid System	Bridge Center Mile Post	Latitude at Center of Bridge	Longitude at Center of Bridge	Bridge Construction Type	Bridge Deck Covering	Load Limit Posted	Headwall/Abutment Construction	Structure Construction	Pier Construction	Piles	Number of Spans	Span Length (ft)	Year Constructed R-Rebuilt	Last Inspection Date
RD-1018-BR3	Teft Street, Bridge 3	25	30.8	49C0461	A	On	2.500	35° 02' 20"	120° 28' 51"	Conc. ArchSpan	REINFORCED CONCRETE		CONC ARCH	Concrete			1	24.7	2009	S12/27/2012
RD-1018-BR1	Teft Street., Bridge 1	93.0	50	49C0142	A	On	2.188	35° 2' 19.38"	120° 28' 53.25	CONCRETE	REINFORCED CONCRETE		REINF CONC	REINF CONC	REINF CONC		2	6	1975	S-10/19/2012
RD-1018-BR2	Teft Street., Bridge 2	33	46.5	49C457	A	On	2.718	35° 2' 37.91"	120° 28' 28.59	Conc. ArchSpan	REINFORCED CONCRETE		CONC ARCH	Concrete			1	24	2009	S11/10/2012
RD-4083-BR1	Templeton Rd., Bridge 1	675	32	49C0177	C	On	0.129	35 32'35.887	120 42'27.269	CONCRETE	REINFORCED CONCRETE		REINF CONC		REINF CONC		7	102	1977	S-7/8/2010
RD-1516-BR2	Thompson Rd., Bridge 2	22	62.3	49C0309	C	On	4.784	35° 3' 1.77"	120° 29' 2.96"	CONCRETE	REINFORCED CONCRETE		REINF CONC	STEEL			1	20	1916	S-10/19/2012
RD-1516-BR1	Thompson Road, Bridge 1	10	100	49C0308	C	On	4.032	35° 2' 32.42"	120° 28' 31.64"	CONCRETE	New		CONC ARCH				1	8	1930	C-6/12/2002
RD-3203-BR1	Tomasini Road, Bridge 1	11.5	28	49C0082	M	Off	0.460			CONCRETE	Conc./AC		REINF CONC				1	10.0	???	C-5/28/2002
RD-4001-BR3	Toro Creek Rd. Cayucos, Bridge 3	57	16	49C0244	M	Off	2.550	35° 25' 53.42"	120° 50' 15.05"	WOOD	WOOD		WOOD	WOOD	WOOD	WOOD	4	14	1950-76	S-10/18/2012
RD-4001-BR1	Toro Creek Rd. Cayucos, Bridge 1	50	20	49C0087	M	Off	0.300	35° 24' 59.41"	120° 52' 6.27"	CONCRETE	REINFORCED CONCRETE		REINF CONC	WOOD		WOOD	2	25	1951	S-5/5/2012
RD-4001-BR2	Toro Creek Rd. Cayucos, Bridge 2	62.3	24.6	49C0422	M	Off	1.150	35° 25' 30.28"	120° 51' 35.94"	CONCRETE	REINFORCED CONCRETE		WOOD	WOOD		WOOD	2	25	1998	S-8/19/2010
RD-4003-BR1	Toro Creek Rd., Bridge 1	45.9	10	49C0384	M	Off	2.700	35 27'42.594	120 46'20.260	WOOD	WOOD		WOOD	STEEL			1	45	1950	S-5/5/2011
RD-2099-BR1	Trout Farm Rd., Bridge 1	134	25	49C00119	M	Off	0.062	35° 11' 6.94"	120° 29' 59.25"	CONCRETE	REINFORCED CONCRETE	YES	ROCK	STEEL		WOOD	7	19	1964	S-7/6/2009
RD-3082-BR1	Turri Rd., Bridge 1	42	27	49C0441	M	Off	7.229	35° 18' 8.10"	120° 46' 34.55"	CONCRETE	CONCRETE		REINF CONC	REINF CONC		STEEL	1	43	2007	S-5/5/2012
RD-1083-BR1	Twenty Second St. Oceano-Bridge 1	136.5	29	49C0128	C	Off	0.094	35° 5' 43.43"	120° 36' 26.32"	CONCRETE	REINFORCED CONCRETE		REINF CONC	REINF CONC		STEEL	4	38	1985	S-4/2/2007
RD-5230-BR2	Union Rd., Bridge 2	29	41.3	49C0428	C	Off	4.490	35 38'15.140	120 34'19.211	DBL. BOX CULVERT	REINFORCED CONCRETE		REINF CONC		REINF CONC		2	14	2000	S-5/5/2012
RD-5230-BR1	Union Road, Bridge 1	215.4	30	49C0297	C	Off	0.785	35 38'07.407	120 37'43.414	CONCRETE	REINFORCED CONCRETE		REINF CONC	REINF CONC	REINF CONC	STEEL	4	60	1994	S-5/5/2012
RD-1151-BR2	Upper Los Berros Rd. Bridge 2	22	24	49C0267	M	Off	0.011	35° 5' 18.26"	120° 30' 35.66"	CONCRETE	REINFORCED CONCRETE		ROCK				1	18	1960	C-7/16/2012
RD-1151-BR3	Upper Los Berros Rd., Bridge 3	42.6	24.6	49C0424	M	Off	0.690	35° 5' 40.60"	120° 30' 10.36"	CONCRETE	REINFORCED CONCRETE		REINF CONC	REINF CONC		STEEL	1	42.3	2000	S-2/22/2011
RD-1151-BR4	Upper Los Berros Rd., Bridge 4	22.5	16	49C0269	M	Off	0.782	35° 5' 42.50"	120° 30' 5.48"	WOOD	REINFORCED CONCRETE		ROCK	WOOD			1	17.8	1940	C-7/16/2012
RD-1151-BR5	Upper Los Berros Rd., Bridge 5	19.2	16		M	Off	1.415	35° 5' 53.68"	120° 29' 30.05"	WOOD	WOOD	Yes	ROCK	WD 20 4X12X20'			1	16.5		C-7/16/2012
RD-1151-BR6	Upper Los Berros Rd., Bridge 6	19	18	49C0270	M	Off	1.971	35° 6' 5.38"	120° 29' 10.94"	WOOD	WOOD 18 4X12X20	Yes	ROCK	WOOD			1	17		C-7/16/2012
RD-1151-BR7	Upper Los Berros Rd., Bridge 7	19.8	18	49C0271	M	Off	2.840	35° 5' 45.90"	120° 28' 14.27"	WOOD	WOOD	Yes	WOOD	WOOD			1	18.5		C-7/16/2012
RD-1151-BR8	Upper Los Berros Rd., Bridge 8	18.7	19	49C0272	M	Off	3.473	35°5' 27.31"	120° 27' 42.68"	WOOD	WOOD	Yes	WOOD	WOOD		WOOD	1	17.2	1965R	C-7/16/2012
RD-1140-BR1	Valley Rd., Bridge 1	91.8	29.8	49C0352	A	On	0.380	35° 6' 112.93"	120° 34' 53.27"	CONCRETE	REINFORCED CONCRETE		REINF CONC		REINF CONC	REINF CONC	3	36	1962	S-10/18/2012
RD-4292-BR2	Villa Creek Rd., Bridge 2	58	22	49C0094	M	Off	1.700	35 29'34.843	120 58'40.842	CONCRETE	REINFORCED CONCRETE		WOOD	WOOD		WOOD	3	19	1957	S-9/28/2008
RD-4063-BR1	Walnut Ave., Bridge 1	97	18	49C0170	M	Off	0.696	35 25'05.433	120 36'21.732	CONCRETE	REINFORCED CONCRETE		REINF CONC	WOOD		WOOD 24	5	19	1940	S-7/8/2010
RD-1073-BR1	Willow Road. Bridge 1	187.95	42.64	49C0454		Off	4.200	35° 3' 22.61"	120° 29' 59.09"	CONCRETE	CIP REINF-CONC. SLAB		REINF CONC	REINF CONC	PCC Piles	PCC Piles	5	46	2012	S-12-27-2012
RD-5108-BR1	Windsor Blvd., Bridge 1	122	36.5	49C0098	C	Off	0.065	35° 34' 43.995"	121° 06' 15.135"	CONCRETE	REINFORCED CONCRETE		REINF CONC	REINF CONC	REINF CONC		3	54	1963	S-5/6/2012

Total 187 Bridges + 1 pending

PED/BIKE BR - Non Vehicular- Ped Bridges

RD-1072-BR1	Beechnut Street, Ped-Bridge 1	?	?							STEEL	WOOD						1	50	2011	C-5/03/12
RD-1072-BR2	Beechnut Street, Ped-Bridge 2	?	?							STEEL	WOOD						2	100	2011	C-5/03/12
RD-4240-BR1	Cabrillo St., Bridge 1	25-30??	12							GLULAM BEAMS	WOOD						1	70	1989	C-11/15/12
RD-5179-BR2	Florence St., Bridge 2 - Templeton	??	??				0.240	35° 33' 00.731"	120° 42' 35.223"	GLULAM BEAMS	WOOD						1	60	2003	C-11/08/12
RD-3106-BR1	J St., BRIDGE NO 1 ,Santa Margarita	-	-	49C0280			0.050	35 23'24.101	120 36'11.626	STEEL I-BEAM	WOOD FOOT BRIDGE						1		1987	C-5/16/12
RD-3100-BR1	Las Pilitas Rd., Bridge 1-PED	249	18	49C0190	M	Off	1.612	35 20'53.660	120 30'47.868	CONCRETE	REINFORCED CONCRETE	Yes	REINF CONC	WOOD/STL	WD/CONC.	WD/CONC.	5	150.75	1916	S-1/11/2007



Object	Description	Bridge Length (ft)	Bridge Width (ft)	State Bridge Number	Road Class	Federal Aid System	Bridge Center Mile Post	Latitude at Center of Bridge	Longitude at Center of Bridge	Bridge Construction Type	Bridge Deck Covering	Load Limit Posted	Headwall/Abutment Construction	Structure Construction	Pier Construction	Piles	Number of Spans	Span Length (ft)	Year Constructed R-Rebuilt	Last Inspection Date
--------	-------------	--------------------	-------------------	---------------------	------------	--------------------	-------------------------	------------------------------	-------------------------------	--------------------------	----------------------	-------------------	--------------------------------	------------------------	-------------------	-------	-----------------	------------------	----------------------------	----------------------

CMP's- Misc

RD-5213-BR1	FEENSTRA RD BRIDGE NO 1M5214 B1						0.010			3-36" CMP's			CMP's							
RD-3084-B1	O' Connor Way, Structure 1		30				2.820			1-96" CMP	AC		CMP						1978	1978
RD-2039-S10	Orcutt Rd., Structure 10	6	??				5.020			6' CMP	AC over fill		CMP				1	6	???	C-???
RD-2039-S11	Orcutt Rd., Structure 11	10	??				6.000			2 - 48" CMP's	AC over fill		CMP				2	4	???	C-???
RD-2039-S5	Orcutt Rd., Structure 5	8.83	64				0.64??			8.83'x6' CMP Arch	AC over fill		8.83' CMP Arch				1	6	1979	C-??
RD-2039-S6	Orcutt Rd., Structure 6	12.5	74				0.710			8'x12.5' CMP Arch	AC over fill		12.5' CMP Arch				1	12.5	1979	C-??
RD-2033-BS1	Soda Lake Rd., Bridge Structure 1									66", 72", and 84" CMP's	AC		CMP's							03/14/2000
RD-1069-S1	Suey Creek Road, Structure	5	22.5				1.600			1/2box culvert-1/2 CMP	AC									2/26/2009
RD-4292-B1	Villa Creek Road-Structure 1												CMP							

Conc Box Culverts < 10'

RD-2039-S1	Orcutt Rd., Structure 1-City SLO	5	65				0.530			4x4 Conc Box Culvert	CONCRETE		4x4 RC Box				1	4	??	C-3/15/2000
RD-2039-S2	Orcutt Rd., Structure 2- City SLO	5	80				0.830			4x4 Conc Box Culvert	CONCRETE		4x4 RC Box				1	4	??	C-3/15/2000
RD-2039-S3	Orcutt Rd., Structure 3- City SLO	8	45				0.940			7x7Conc Box Culvert	CONCRETE		7x7 RC Box				1	7	??	C-3/15/2000
RD-5086-BR2	Santa Rosa Creek Rd., Struct 2	10	42				1.649	Didn't find	Didn't find	8x8 Box Culvert	REINFORCED CONCRETE		REINF CONC				1	10	1960+-	C-6/19/2002

**Appendix B: Caltrans Structure Maintenance and  
Investigations List (NBI)**



# Structure Maintenance & Investigations

## Local Agency Bridge List

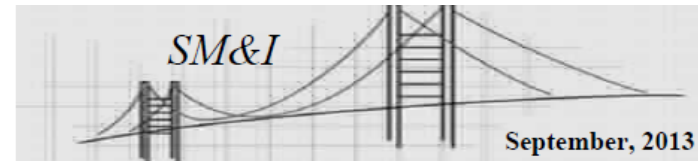

### San Luis Obispo County District 05

#### County of San Luis Obispo

Bridge Number	Feature Intersected	Facility Carried	Location	NBI Bridge	SD/FO	Suff Rating	Health Index	PCI	Year Built	ADT	Road Lanes	Road Width	Road Length	On/Off Federal Aid System	On/Off NHS Highway	Functional Class
49C0017	BRANCH OF LAS TABLAS CRK	CYPRESS MT DR	0.2 MI NW OF KLAU	NBI Bridge		74.4	94.89		1950	25	2	5.5	17	Off	Off	09 Rural Local
49C0029	LAS TABLAS CREEK	KLAU MINE RD	2.7 MI SW ADELAIDA	NBI Bridge		72.1	100		1940	93	2	6.7	9	Off	Off	08 Rural min Collector
49C0032	KLAU CREEK	CYPRESS MT DR	1.6 MI SW OF KLAU	NBI Bridge		59.4	94.24		1953	25	1	3.9	9	Off	Off	08 Rural min Collector
49C0033	KLAU CREEK	CYPRESS MT RD	1.9 MI SW KLAU	NBI Bridge	SD	28.4	95.77		1953	25	1	4.3	9	Off	Off	08 Rural min Collector
49C0037	JACK CREEK	DOVER CANYON RD	1.3 MI SW OF VINEYARD DR	NBI Bridge	SD	19.2	51.84	50	1920	151	1	4.8	19	Off	Off	09 Rural Local
49C0048	ESTRELLA RIVER	ESTRELLA ROAD	AT ESTRELLA RD	NBI Bridge		97.7	99.63		1978	249	2	8.5	92	On	Off	07 Rural Mjr Collector
49C0052	HUER HUERO CREEK	RIVER ROAD	1.5 MI S WELLONA AVE	NBI Bridge		78.1	99.41		1950	269	2	6.1	30	Off	Off	09 Rural Local
49C0063	HUER HUERO CREEK	CRESTON RD	0.1 MI S GENESEO RD	NBI Bridge		91.0	100		1960	1731	2	9.2	56	On	Off	07 Rural Mjr Collector
49C0070	CHOLAME CREEK	CHOLAME VALLEY RD	1.4 MI NW SR 46	NBI Bridge		66.3	91.39		1948	130	2	6.2	24	Off	Off	08 Rural min Collector
49C0073	CHOLAME CREEK	BITTERWATER ROAD	WEST OF SH 46	NBI Bridge		99.8	100		1979	112	2	9.8	42	On	Off	07 Rural Mjr Collector
49C0084	STENNER CREEK	STENNER CREEK RD	0.05 MI N SR 1	NBI Bridge		90.6	100		1959	150	2	8.5	12	Off	Off	09 Rural Local
49C0085	STENNER CREEK	STENNER CREEK RD	1.25 MI N SR 1	NBI Bridge	FO	57.8	63.86	50	1970	150	1	3.8	13	Off	Off	09 Rural Local
49C0087	TORO CREEK	TORO CREEK RD	0.3 MI E SR 1	NBI Bridge		65.5	95.34		1951	247	2	6.1	16	Off	Off	09 Rural Local
49C0093	OLD CREEK	SNTA RTA OLD CR RD	0.3 MI E CYPRESS MTN DR	NBI Bridge	SD	68.1	93.46		1940	249	2	6.7	32	Off	Off	08 Rural min Collector
49C0094	VILLA CREEK	VILLA CREEK RD	1.8 MI N SR 1	NBI Bridge		82.0	95.76		1957	100	2	6.1	18	Off	Off	09 Rural Local
49C0097	SANTA ROSA CREEK	BURTON RD	0.15 MI S MAIN ST CAMBRI	NBI Bridge		55.5	98.58		1968	4125	2	8.5	37	Off	Off	09 Rural Local
49C0098	SANTA ROSA CREEK	WINDSOR BLVD	200' SOUTH OF SR 1	NBI Bridge		61.0	98.89		1963	3416	2	8.6	37	Off	Off	09 Rural Local
49C0103	SAN SIMEON CREEK	SAN SIMEON CRK RD	5.7 MI E OF SR 1	NBI Bridge	FO	71.1	97.34		1964	670	1	4.9	24	Off	Off	09 Rural Local
49C0105	E BR SAN LUIS OBISPO CRK	BUCKLEY RD	0.5 MI S HIGUERA ST	NBI Bridge		52.3	91.31		1915	4717	2	8.6	8	Off	Off	08 Rural min Collector
49C0106	E BR SAN LUIS OBISPO CRK	BUCKLEY ROAD	1.5 MI E OF US 101	NBI Bridge		78.9	93.02	50	1956	4396	2	8.5	25	On	Off	16 Urban Minor Arterial
49C0112	PISMO CREEK	ORMONDE RD	0.1 MI E PRICE CANYON RD	NBI Bridge		96.8	100		1978	590	2	8.5	42	Off	Off	08 Rural min Collector
49C0113	WEST CORRAL DE PIEDRA CR	ORCUTT ROAD	0.25 MI SE BIDDLE ROAD	NBI Bridge	FO	73.4	97.46		1949	2438	2	7.3	10	On	Off	07 Rural Mjr Collector
49C0119	ARROYO GRANDE CREEK	TROUT FARM RD	6.9 MI N OF SR 101	NBI Bridge		75.7	75.62	75	1964	100	2	7.3	42	Off	Off	09 Rural Local



# Structure Maintenance & Investigations

## Local Agency Bridge List

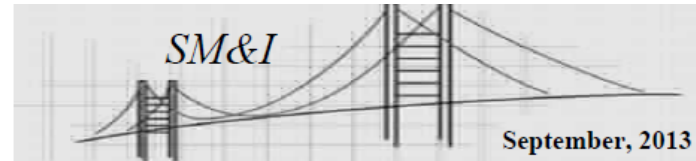

### San Luis Obispo County District 05

#### County of San Luis Obispo

Bridge Number	Feature Intersected	Facility Carried	Location	NBI Bridge	SD/FO	Suff Rating	Health Index	PCI	Year Built	ADT	Road Lanes	Road Width	Road Length	On/Off Federal Aid System	On/Off NHS Highway	Functional Class
49C0121	ARROYO GRANDE CREEK	HI MOUNTAIN RD	1.5 MI E LOPEZ CYN RD	NBI Bridge	FO	60.1	75.86		1965	50	2	7.4	17	Off	Off	09 Rural Local
49C0122	SAUCELITO CREEK	HI MOUNTAIN RD	2.5 MI E LOPEZ CANYON RD	NBI Bridge	FO	74.9	99.53		1966	487	2	6.0	14	Off	Off	09 Rural Local
49C0124	ARROYO GRANDE CREEK	HUASNA RD	0.04 MI SE LOPEZ DR	NBI Bridge	FO	54.7	87.18		1923	966	2	6.0	14	On	Off	07 Rural Mjr Collector
49C0125	OCEANO BEACH LAGOON	AIR PARK DR	0.1 MI SE OF PIER AVE	NBI Bridge	SD	21.5	89.83		1940	448	2	5.8	24	On	Off	17 Urban Collector
49C0126	OCEANO BEACH LAGOON	LAKESIDE AVE	0.1 MI S OF PIER AVE	NBI Bridge		89.0	99.73		1940	100	2	5.9	44	Off	Off	19 Urban Local
49C0128	ARROYO GRANDE CREEK	22ND STREET	0.2 MI SOUTH OF SR-1	NBI Bridge		87.7	100		1985	663	2	8.5	42	Off	Off	09 Rural Local
49C0131	LOS BERROS CREEK	EL CAMPO RD	0.1 MI NE LS BRS-ARY G RD	NBI Bridge	FO	71.4	98.98		1956	1161	2	6.1	20	Off	Off	09 Rural Local
49C0142	NIPOMO CREEK	W TEFFT ST	0.25 MI E SR 101	NBI Bridge		92.8	100		1975	8796	2	12.2	28	On	Off	16 Urban Minor Arterial
49C0143	TAR SPRINGS CREEK	BRANCH MILL RD	0.25 MI SW/O HUASNA RD	NBI Bridge	SD	47.8	60.97	50	1949	1240	2	6.8	28	Off	Off	08 Rural min Collector
49C0146	WEST BRANCH HUASNA CREEK	HUASNA RD	HUASNA TOWNSITE RD	NBI Bridge	FO	56.9	98.74		1930	401	2	6.4	8	On	Off	07 Rural Mjr Collector
49C0147	HUASNA RIVER	HUASNA TOWNSITE RD	3.1 MI SE OF HUASNA	NBI Bridge	SD	33.7	96.95		1965	288	1	3.9	53	Off	Off	09 Rural Local
49C0150	SEE CANYON CREEK	SAN LUIS BAY DR	0.9 MI W OF US 101	NBI Bridge	FO	75.9	94.06		1940	6830	2	8.4	10	On	Off	07 Rural Mjr Collector
49C0152	DAVENPORT CREEK	DAVENPORT CREEK RD	0.7 MI S BUCKLEY RD	NBI Bridge	FO	50.3	96.15		1959	1373	2	6.7	26	Off	Off	09 Rural Local
49C0155	QUIEN SABE CREEK	CORBETT CANYON RD	0.8 MI SE SR 227	NBI Bridge		67.0	100		1938	1433	2	7.3	7	On	Off	07 Rural Mjr Collector
49C0169	TROUT CREEK	ASUNCION ROAD	0.25 MI NE EL CAMINO REAL	NBI Bridge		88.5	100		1969	371	2	9.1	8	Off	Off	09 Rural Local
49C0170	SANTA MARGARITA CREEK	WALNUT AVE	BTWN PINE AV & CHSTNUT AV	NBI Bridge	FO	83.6	95.01		1940	271	1	5.4	29	Off	Off	19 Urban Local
49C0171	SANTA MARGARITA CREEK	LINDEN AVE	0.05 MI W EL CAMINO REAL	NBI Bridge		71.5	98.95		1955	341	2	6.1	21	Off	Off	19 Urban Local
49C0172	YERBA BUENA CREEK	I STREET	0.05 MI SW OF S.R. 58	NBI Bridge		97.0	100		1950	100	2	9.3	12	On	Off	17 Urban Collector
49C0173	YERBA BUENA CREEK	ENCINA AVE	0.5 MI SE/O I ST	NBI Bridge		69.2	100		1984	1365	2	8.6	11	On	Off	17 Urban Collector
49C0177	SALINAS RIVER	VINEYARD DR	0.3 MI E OF U.S. 101	NBI Bridge		92.5	100		1977	4119	2	9.8	205	On	Off	06 Rural Minor Arterial
49C0191	PILITAS CREEK	LAS PILITAS RD	2.4 MI E SANTA MARG RD	NBI Bridge	FO	54.5	70.5	50	1930	189	2	5.5	9	Off	Off	09 Rural Local
49C0192	PILITAS CREEK	LAS PILITAS RD	3.8 MI E SANTA MARG RD	NBI Bridge	FO	79.0	74.06	50	1930	262	1	5.3	8	Off	Off	09 Rural Local



# Structure Maintenance & Investigations

Local Agency Bridge List

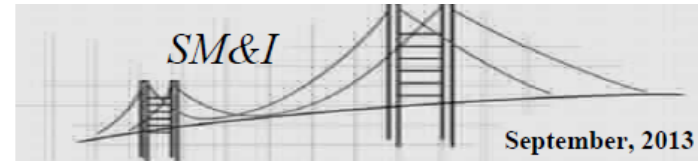

## San Luis Obispo County District 05

County of San Luis Obispo

Bridge Number	Feature Intersected	Facility Carried	Location	NBI Bridge	Suff SD/FO	Health Rating	Index	PCI	Year Built	ADT	Road Lanes	Width	Length	On/Off Federal Aid System	On/Off NHS Highway	Functional Class
49C0194	POZO CREEK	PARKHILL RD	0.15 MI N POZO RD	NBI Bridge		79.6	81.06	50	1956	170	2	7.3	13	Off	Off	08 Rural min Collector
49C0207	HARMONY CREEK	SLO-SAN SIMEON RD	IN HARMONY	NBI Bridge		69.5	50.75		1906	20	1	0.0	9	Off	Off	09 Rural Local
49C0210	VINEYARD CREEK	INDIAN VALLEY RD	1.91 MI N OF CROSS CYN RD	NBI Bridge		98.1	100		1980	631	2	8.5	34	Off	Off	08 Rural min Collector
49C0215	HOG CANYON CREEK	HOG CANYON RD	3.4 MI NE OF ESTRELLA RD	NBI Bridge	FO	59.0	96.17		1960	1267	2	5.9	12	Off	Off	08 Rural min Collector
49C0216	RANCHITA CANYON CREEK	ESTRELLA RD	0.5 MI E PLEASANT RD	NBI Bridge	FO	76.6	100		1940	529	2	6.2	18	On	Off	07 Rural Mjr Collector
49C0222	LAGUNA CREEK	FOOTHILL ROAD	0.3 MI N LOS OSOS VALY RD	NBI Bridge		90.4	100		1959	8654	2	10.7	11	On	Off	16 Urban Minor Arterial
49C0226	PREFUMO CANYON CREEK	PREFUMO CANYON RD	1.8 MI SW LOS OSOS VLY RD	NBI Bridge		93.9	100		1969	300	2	8.6	9	Off	Off	08 Rural min Collector
49C0227	PREFUMO CANYON CREEK	PREFUMO CANYON RD	2.0 MI W LOS OSOS VLLY RD	NBI Bridge		94.8	100		1974	300	2	8.5	14	Off	Off	08 Rural min Collector
49C0228	PREFUMO CANYON CREEK	PREFUMO CANYON RD	2.45 MI W LOS OSOS VLY RD	NBI Bridge		93.6	100		1974	300	2	8.5	12	Off	Off	08 Rural min Collector
49C0235	SAN LUISITO CREEK	SAN LUISITO RD	0.15 MI N SR 1	NBI Bridge		78.6	100		1957	100	2	6.1	16	Off	Off	09 Rural Local
49C0238	LOS OSOS CREEK	LOS OSOS VALLEY RD	LOS OSOS VALLEY ROAD	NBI Bridge		88.3	100		1991	16105	4	23.2	27	On	Off	16 Urban Minor Arterial
49C0239	ISLAY CREEK	PECHO VALLEY RD	4.9 MI SW BAYWOOD PARK	NBI Bridge		68.5	97.97		1974	1790	2	8.6	14	On	Off	07 Rural Mjr Collector
49C0244	TORO CREEK	TORO CREEK RD	2.5 MI NE OF SR 1	NBI Bridge	FO	79.5	96.01		1965	30	1	4.9	18	Off	Off	09 Rural Local
49C0246	COTTONTAIL CREEK	COTTONTAIL CR RD	2.67 MI W OF CYPRESS MT R	NBI Bridge	FO	62.0	99.53		1940	100	1	5.1	10	Off	Off	09 Rural Local
49C0247	CAYUCOS CREEK	CAYUCOS CR RD	THUNDER CANYON RD	NBI Bridge	FO	46.0	79.97		1928	276	2	5.4	6	Off	Off	09 Rural Local
49C0254	HEARST RANCH CREEK	SLO-SAN SIMEON RD	JUST W/O SR 1	NBI Bridge		79.0	98.99		1916	100	2	5.5	16	Off	Off	09 Rural Local
49C0259	TORO CREEK	RIVER RD	2.4 MI N OF POSO RD	NBI Bridge		97.9	100		1986	100	2	7.9	18	Off	Off	09 Rural Local
49C0261	SQUIRE CREEK	MONTE RD	0.25 MI S/O SAN LUIS B DR	NBI Bridge	FO	51.8	100		1958	200	1	5.4	9	Off	Off	09 Rural Local
49C0274	HUASNA RIVER	HUASNA RD	2.55 MI E OF HUASNA	NBI Bridge	FO	58.5	99.48		1940	401	1	4.8	59	Off	Off	09 Rural Local
49C0278	BRA SANTA MARGARITA CRK	NORTE RD	WEST OF OAK RD	NBI Bridge	FO	72.0	99.38		1956	50	1	4.8	7	Off	Off	09 Rural Local
49C0279	YERBA BUENA CREEK	H STREET	0.02 MI S/W OF SH 58	NBI Bridge		96.0	100		1971	100	2	8.5	9	Off	Off	19 Urban Local
49C0281	SANTA MARGARITA CREEK	TASSAJARA CR RD	WEST OF RTE 101	NBI Bridge	FO	61.8	69.99	43.9	1940	228	1	5.2	10	Off	Off	09 Rural Local
49C0282	E BRANCH HUER HUERO CRK	O'DONOVAN RD	0.7 MI NW OF S.R. 58	NBI Bridge		87.4	97.75		1942	535	2	7.7	12	Off	Off	08 Rural min Collector



# Structure Maintenance & Investigations

## Local Agency Bridge List

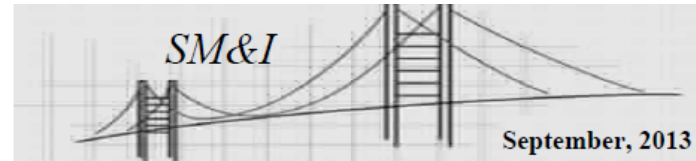

September, 2013

### San Luis Obispo County District 05

#### County of San Luis Obispo

Bridge Number	Feature Intersected	Facility Carried	Location	NBI Bridge	Suff SD/FO	Health Rating	PCI	Year Built	ADT	Road Lanes	Width	Length	On/Off Federal Aid System	On/Off NHS Highway	Functional Class
49C0291	N BR GREEN VALLEY CREEK	GREEN VALLEY RD	0.3 MI N SR 46	NBI Bridge	FO	75.1 98.84		1958	50	1	4.9	16	Off	Off	09 Rural Local
49C0297	HUER HUERO CREEK	UNION RD	1.5 MI S OF SR 46	NBI Bridge		78.3 99.6		1994	5032	2	9.1	66	Off	Off	08 Rural min Collector
49C0302	RINCONADA CREEK	POZO ROAD	LAS PILITAS RD	NBI Bridge		90.4 100		1959	1112	2	9.1	25	Off	Off	08 Rural min Collector
49C0303	DRY CREEK	POZO ROAD	0.3 MI W RIVER RD	NBI Bridge		67.1 81.97		1941	787	2	6.7	18	On	Off	07 Rural Mjr Collector
49C0304	SALINAS RIVER	POZO RD	RIVER ROAD	NBI Bridge		88.6 100		1989	787	2	8.5	73	On	Off	07 Rural Mjr Collector
49C0305	POZO CREEK	POZO ROAD	HI MOUNTAIN ROAD	NBI Bridge		97.3 100		1970	787	2	9.8	22	On	Off	07 Rural Mjr Collector
49C0307	ESTRELLA RIVER	GROVE DR	0.15 MI E OF ESTRELLA RD	NBI Bridge	SD	25.1 65.91 57.89		1910	100	1	4.8	49	Off	Off	09 Rural Local
49C0309	DELEISSIGUES CREEK	THOMPSON RD	0.75 MI NW TEFPT ST	NBI Bridge		73.7 72.81		1916	5834	2	14.8	7	On	Off	16 Urban Minor Arterial
49C0310	SANTA MARGARITA CREEK	EL CAMINO REAL	AT ASUNCION RD	NBI Bridge	SD	48.4 59.07	50	1930	5046	2	10.2	25	On	Off	17 Urban Collector
49C0319	LAS TABLAS CREEK	LAKEVIEW DR	3.8 MI N CHIMNEY ROCK RD	NBI Bridge		57.1 59.6 44.2		1959	260	2	6.7	65	On	Off	07 Rural Mjr Collector
49C0320	LITTLE CAYUCOS CREEK	ASH ST	D ST & E ST IN CAYUCOS	NBI Bridge		97.9 100		1990	638	2	12.2	20	Off	Off	19 Urban Local
49C0322	E BR SAN LUIS OBISPO CRK	JESPERSEN RD	0.2 MI S BUCKEY RD	NBI Bridge	FO	79.3 100		1959	80	1	5.0	29	Off	Off	09 Rural Local
49C0327	SAN LUIS OBISPO CREEK	AVILA BEACH DR	AVILA RD	NBI Bridge		61.0 98.79		1967	7434	2	8.5	146	On	Off	16 Urban Minor Arterial
49C0328	SAN LUIS OBISPO CREEK	SAN LUIS BAY DRIVE	0.15 MI E S.R. 1	NBI Bridge	FO	76.7 99.94		1964	7475	2	8.6	32	Off	Off	09 Rural Local
49C0329	UP RR & AMTRAK	PRICE CANYON ROAD	0.35 MI SW/O SR 227	NBI Bridge	SD	65.1 99.23		1963	6003	2	8.6	41	On	Off	07 Rural Mjr Collector
49C0330	W BR CORRAL DE PIEDRA CR	PRICE CYN RD	0.2 MI SW OF SR 227	NBI Bridge	SD	66.3 100		1963	6003	2	8.5	46	On	Off	07 Rural Mjr Collector
49C0333	TASSAJARA CREEK	TASSAJARA RD	2.1 MI W US 101	NBI Bridge	FO	68.2 87.34		1960	228	1	4.1	8	Off	Off	09 Rural Local
49C0335	WILLOW CREEK	OCEAN BLVD	0.1 MI S CYPRESS MTN DR	NBI Bridge	FO	65.5 97.58		1925	1044	2	7.0	8	Off	Off	19 Urban Local
49C0337	SANTA ROSA CREEK	MAIN ST	1.2 MI N OF SR 1	NBI Bridge	FO	50.4 99.73		1922	3509	2	6.5	28	On	Off	16 Urban Minor Arterial
49C0341	CAYUCOS CREEK	OCEAN BLVD	CAYUCOS	NBI Bridge		81.3 100		1951	635	2	7.9	59	Off	Off	19 Urban Local
49C0342	PASO ROBLES CREEK	JACK CREEK RD	0.2 MI N STATE RTE 46	NBI Bridge	SD	50.8 86		1938	151	2	7.4	62	Off	Off	09 Rural Local
49C0344	SANTA ROSA CREEK	SANTA ROSA CR RD	3.0 MI W CYPRESS MTN DR	NBI Bridge		80.6 100		1947	128	2	7.9	11	Off	Off	08 Rural min Collector



# Structure Maintenance & Investigations

## Local Agency Bridge List

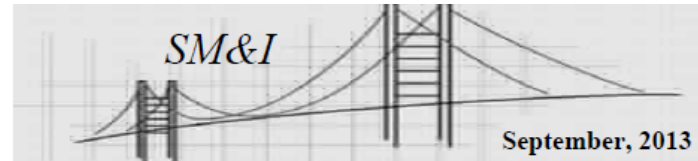

### San Luis Obispo County District 05

#### County of San Luis Obispo

Bridge Number	Feature Intersected	Facility Carried	Location	NBI Bridge	SD/FO	Suff Rating	Health Index	PCI	Year Built	ADT	Road Lanes	Road Width	Road Length	On/Off Federal Aid System	On/Off NHS Highway	Functional Class
49C0345	ROCKY CREEK	SANTA ROSA CR RD	1.0 MI NW SR 46	NBI Bridge		61.1	100		1948	1204	2	7.9	12	Off	Off	08 Rural min Collector
49C0346	HUER HUERO CREEK	RIVER RD	1.55 MI S WELLSONA AVE	NBI Bridge	FO	74.7	98.92		1965	569	2	6.2	35	On	Off	07 Rural Mjr Collector
49C0348	PASO ROBLES CREEK	SNTA RITA OLD CK R	0.9 MI SWVINEYARD DR	NBI Bridge		93.1	100		1971	538	2	8.5	45	Off	Off	08 Rural min Collector
49C0351	LOS OSOS CREEK	SOUTH BAY BLVD	2.15 MI SOUTH OF SR 1	NBI Bridge	FO	68.1	99.28		1966	15232	2	9.1	58	On	Off	06 Rural Minor Arterial
49C0352	LOS BERROS CRK DIV CHNL	VALLEY RD	0.4 MI N SR 1	NBI Bridge	FO	59.5	100		1962	5167	2	8.5	28	On	Off	17 Urban Collector
49C0353	LOPEZ LAKE SPILLWAY	LOPEZ DR	2.64 MI N/E ORCUTT RD	NBI Bridge		73.2	92.75		1968	2728	2	9.8	22	On	Off	07 Rural Mjr Collector
49C0354	LOPEZ LAKE	LOPEZ DR	4.8 MI NE OF ORCUTT RD	NBI Bridge		92.8	99.22		1968	1857	2	9.8	97	On	Off	07 Rural Mjr Collector
49C0355	SAN MARCOS CREEK	NACIMIENTO LAKE DR	0.05 MI S SAN MARCOS RD	NBI Bridge		83.0	66.67		1964	4973	2	0.0	18	On	Off	06 Rural Minor Arterial
49C0379	E BR SAN LUIS OBISPO CRK	BUCKLEY RD	1.5 MI E US 101	NBI Bridge		78.9	100		1978	4396	2	8.6	10	Off	Off	08 Rural min Collector
49C0384	TORO CREEK	TORO CREEK RD	2.7 MI W SR 41	NBI Bridge	FO	43.2	50.73	38.4	1950	262	1	2.7	14	Off	Off	09 Rural Local
49C0385	W BRANCH OF CAYUCOS CRK	CO. RD. M4296	1 MI NW CAYUCOS RD	NBI Bridge	FO	68.0	97.1		1960	100	1	5.2	13	Off	Off	09 Rural Local
49C0391	SEE CANYON CREEK	PIPPEN LANE	.1 MI N/O SEE CANYON RD	NBI Bridge	FO	65.8	100		1950	30	1	3.3	9	Off	Off	09 Rural Local
49C0396	SAN LUIS OBISPO CREEK	HIGUERA ST	AT SR 101	NBI Bridge	SD	74.2	93.39		1928	4927	2	9.1	81	On	Off	07 Rural Mjr Collector
49C0402	TEMPLETON CREEK	MAIN ST	0.35 MI SOUTH RAMADA DR	NBI Bridge		71.6	67.31		1929	6836	2	13.9	8	On	Off	16 Urban Minor Arterial
49C0403	NORTH FORK TEMPLETON CRK	MAIN ST	0.3 MI SOUTH RAMADA DR	NBI Bridge		71.6	100		1929	6836	2	16.6	7	On	Off	16 Urban Minor Arterial
49C0404	NIPOMO CREEK	HUTTON ROAD	0.55 MI N CUYAMA LANE	NBI Bridge	FO	50.7	100		1957	6688	2	7.3	31	On	Off	16 Urban Minor Arterial
49C0410	SAN LUIS OBISPO CREEK	ONTARIO ROAD	0.3 MI N AVILA ROAD	NBI Bridge		93.4	100		1994	1620	2	9.1	220	Off	Off	19 Urban Local
49C0411	DRAINAGE CHANNEL	SODA LAKE RD	1.5 miles south of SR 58	NBI Bridge		94.7	100		1987	202	2	9.1	11	On	Off	07 Rural Mjr Collector
49C0412	MCMILLAN CANYON CREEK	McMILLAN CANYON RD	0.25 MI SOUTH OF SR 46	NBI Bridge		95.5	100		1996	2086	2	9.4	14	Off	Off	09 Rural Local
49C0413	ESTRELLA RIVER	McMILLAN CANYON RD	0.5 MI SOUTH OF SR 46	NBI Bridge		94.5	100		1996	2086	2	9.4	129	Off	Off	09 Rural Local
49C0414	OCEANO BEACH LAGOON	PIER AVE	0.2 MI W OF SR 1	NBI Bridge		91.5	100		1994	5037	4	17.8	19	On	Off	17 Urban Collector
49C0416	RANCHITA CREEK	RANCHITA CANYON RD	0.5 MI S CROSS CANYONS RD	NBI Bridge		95.2	100		1996	655	2	8.5	21	Off	Off	09 Rural Local



# Structure Maintenance & Investigations

## Local Agency Bridge List

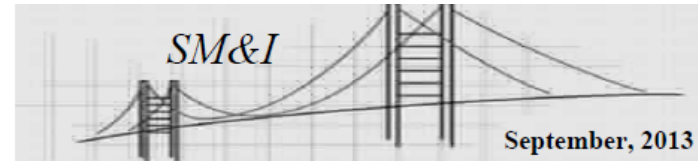

### San Luis Obispo County District 05

#### County of San Luis Obispo

Bridge Number	Feature Intersected	Facility Carried	Location	NBI Bridge	SD/FO	Suff Rating	Health Index	PCI	Year Built	ADT	Road Lanes	Road Width	Road Length	On/Off Federal Aid System	On/Off NHS Highway	Functional Class
49C0417	RANCHITA CREEK	RANCHITA CANYON RD	1.7 MI N CROSS CYN RD	NBI Bridge		89.0	100		1997	655	2	7.5	19	Off	Off	09 Rural Local
49C0418	RANCHITA CREEK	RANCHITA CANYON RD	2.5 MI N CROSS CYN RD	NBI Bridge		87.3	100		1997	655	2	7.3	19	Off	Off	09 Rural Local
49C0419	RANCHITA CREEK	RANCHITA CANYON RD	2.9 MI N CROSS CYN RD	NBI Bridge		88.3	100		1997	655	2	7.3	13	Off	Off	09 Rural Local
49C0420	HUER HUERO CREEK	LINNE RD	4 MI E SR101	NBI Bridge		91.9	100		1996	1568	2	8.7	63	Off	Off	09 Rural Local
49C0421	SAN LUIS OBISPO CREEK	RESERVOIR CANYN RD	0.1 miles S. of US 101	NBI Bridge		97.8	100		1998	100	2	7.3	18	Off	Off	09 Rural Local
49C0422	TORO CREEK	TORO CREEK ROAD	1.15 miles NE of HWY 1	NBI Bridge		87.0	100		1998	247	2	7.3	19	Off	Off	09 Rural Local
49C0424	LOS BERROS CREEK	UPPER LOS BERROS R	1 MI NE DANA FOOTHILL	NBI Bridge		90.2	100		2000	328	2	7.5	13	Off	Off	19 Urban Local
49C0425	LOS BERROS CREEK	CENTURY LANE	JEO LOS BANOS RD	NBI Bridge		97.0	100		1996	250	2	0.0	20	Off	Off	09 Rural Local
49C0427	HUER HUERO CREEK	O'DONOVAN ROAD	Huer Huero Creek	NBI Bridge		99.8	100		1999	100	2	8.7	51	Off	Off	09 Rural Local
49C0428	DRY CREEK	UNION ROAD	Between Branch & Geneseo	NBI Bridge		99.7	100		2000	801	2	0.0	13	Off	Off	08 Rural min Collector
49C0429	CHORRO CREEK	CANET ROAD	0.3 MI SW OF SR 1	NBI Bridge	FO	74.3	100		2000	150	1	3.9	8	Off	Off	09 Rural Local
49C0435	SALINAS RIVER	LAS PILITAS RD	SLO CTY	NBI Bridge		88.5	100		2006	500	2	7.3	76	Off	Off	09 Rural Local
49C0436	SAN SIMEON CREEK	SAN SIMEON CRK RD	3.5 MI EAST OF SR 1	NBI Bridge		98.8	100		2012	250	2	8.2	42	Off	Off	09 Rural Local
49C0437	SAN SIMEON CREEK	SAN SIMEON CRK RD	2.65 MI EAST OF HWY 1	NBI Bridge		92.1	100		2011	500	2	8.1	45	Off	Off	09 Rural Local
49C0438	SAN LUIS OBISPO CREEK	SAN LUIS BAY DR	AVILA RD	NBI Bridge		97.9	100		2009	500	2	13.4	67	On	Off	06 Rural Minor Arterial
49C0441	N BR LOS OSOS CREEK	TURRI RD	.16 MI N OF LOS OSOS V RD	NBI Bridge		95.9	100		2007	414	2	8.5	13	Off	Off	09 Rural Local
49C0443	CAYUCOS CREEK	PICACHIO ROAD	1.9 MI N OF CAYUCOS	NBI Bridge		92.1	100		2007	100	2	7.0	19	Off	Off	09 Rural Local
49C0444	SALINAS RIVER	RIVER ROAD	0.5 MI E MISSION ST	NBI Bridge		99.3	100		2005	500	2	9.7	337	Off	Off	09 Rural Local
49C0448	LEFFINGWELL CREEK	MOONSTONE BEACH DR	SOUTH OF STATE PARK RD	NBI Bridge		100.0	100		2011	500	2	12.2	90	On	On	02 Rural Other Princ
49C0454	NIPOMO CREEK	WILLOW ROAD	0.2 MI EAST OF US 101	NBI Bridge		99.8	99.98		2012	1000	2	12.2	57	Off	Off	09 Rural Local
49C0455	SANTA ROSA CREEK	FERRASCI ROAD	.1 MI E. OF S. ROSA CRK RD	NBI Bridge		85.4	100		2011	150	2	6.8	29	Off	Off	09 Rural Local
49C0456	SAN LUISITO CREEK	ADOBE ROAD	0.1 MI W. OF SAN LUISITO	NBI Bridge		75.8	100		1948	101	2	9.3	8	Off	Off	09 Rural Local
49C0457	EAST BRANCH NIPOMO CREEK	W TEFFT STREET	W TEFT ST AT S BURTON ST	NBI Bridge		99.5	100		2009	9800	2	14.1	10	Off	Off	19 Urban Local
49C0461	EAST BRANCH NIPOMO CREEK	EAST TEFFT STREET	AT AVOCADO AVENUE	NBI Bridge		94.4	100		2009	1000	2	9.4	8	On	Off	16 Urban Minor Arterial
49C0464	SAN JUAN CREEK	CENTRE STREET	160 FT E/O 5TH STREET	NBI Bridge		89.7	100	100	1941	750	2	7.9	79	On	Off	07 Rural Mjr Collector





# Structure Maintenance & Investigations

Local Agency Bridge List

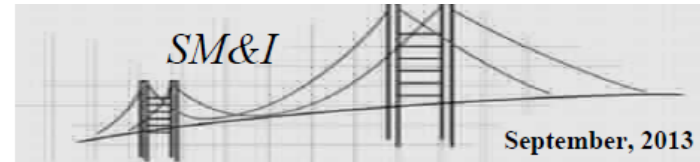

## San Luis Obispo County District 05

County of San Luis Obispo

Bridge Number	Feature Intersected	Facility Carried	Location	NBI Bridge	Suff SD/FO Rating	Health Index	PCI	Year Built	ADT	Road Lanes	Width	Length	On/Off Federal Aid System	On/Off NHS Highway	Functional Class
49C0468	BRANCH LAS TABLAS CREEK	CYPRESS MOUNTAIN	1.3 MI. NW KLAU MINE RD	NBI Bridge	83.0	100		1996	200	2	6.4	7	Off	Off	09 Rural Local

## **Appendix C: Total Bridges per County**

# Map 1: Total Bridges Per County

## 11,653 Total Local Agency Bridges

Numbers Shown for each County:

- **Total Bridges**
- Total Off System
- % Rehabilitation Eligible (SR ≤80.0)
- % Replacement Eligible (SR <50.0)
- Bridge Projects

	<b>1-49</b>
	<b>50-99</b>
	<b>100-199</b>
	<b>200-399</b>
	<b>400 or more</b>

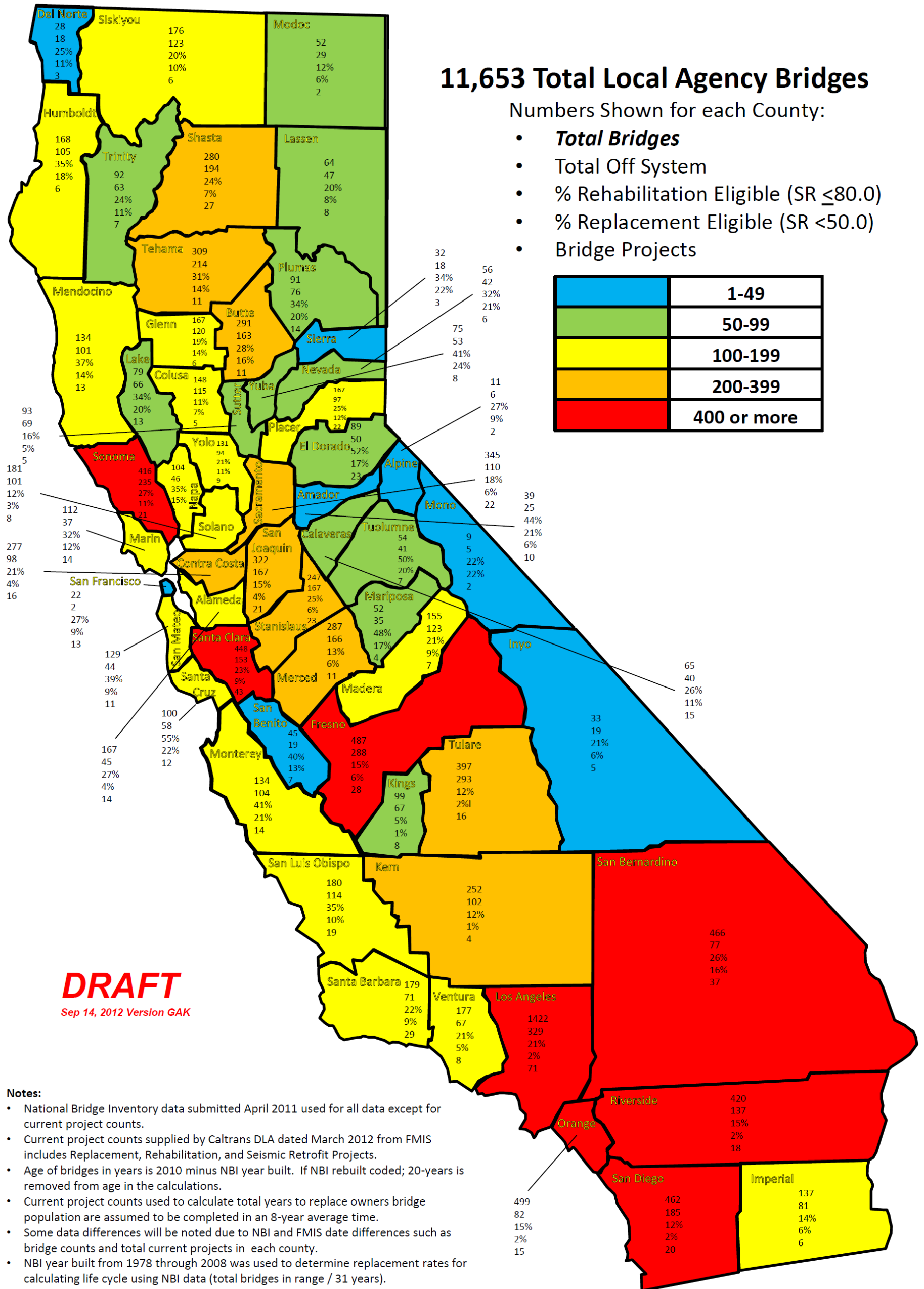

**DRAFT**  
Sep 14, 2012 Version GAK

### Notes:

- National Bridge Inventory data submitted April 2011 used for all data except for current project counts.
- Current project counts supplied by Caltrans DLA dated March 2012 from FMIS includes Replacement, Rehabilitation, and Seismic Retrofit Projects.
- Age of bridges in years is 2010 minus NBI year built. If NBI rebuilt coded; 20-years is removed from age in the calculations.
- Current project counts used to calculate total years to replace owners bridge population are assumed to be completed in an 8-year average time.
- Some data differences will be noted due to NBI and FMIS date differences such as bridge counts and total current projects in each county.
- NBI year built from 1978 through 2008 was used to determine replacement rates for calculating life cycle using NBI data (total bridges in range / 31 years).
- Total bridges in the county include NBI owner codes 2, 3, and 4 (county, town, and city owners). Other local agency owned bridges are uncommon.
- NBI function class 08, 09, and 19 define bridges off Federal-aid routes. All other function class codes are on Federal-aid routes.

**Appendix D: Average Age of Bridge Populations by  
County in California**

# Map 11: Average Age (Yrs) of Bridge Populations

**Nationwide Average Age: 40**  
**California LA Average Age: 46\***  
**Numbers Shown for each County:**

- Total County/City Bridges
- **Average Age of Bridge Population**
- Bridges Built/Year (1978-2008) for 2010
- Years to Replace Bridge Population at Built/Year Rate
- Total FMIS Bridge Projects (March 2012)
- Years to Replace Bridge Population using Current Project Numbers (8-Yr Project Life)

	<b>35 and Less</b>
	<b>36-40</b>
	<b>41-45</b>
	<b>46-50</b>
	<b>More than 50</b>

• Without rehab consideration:  
 Average age is 48 years.

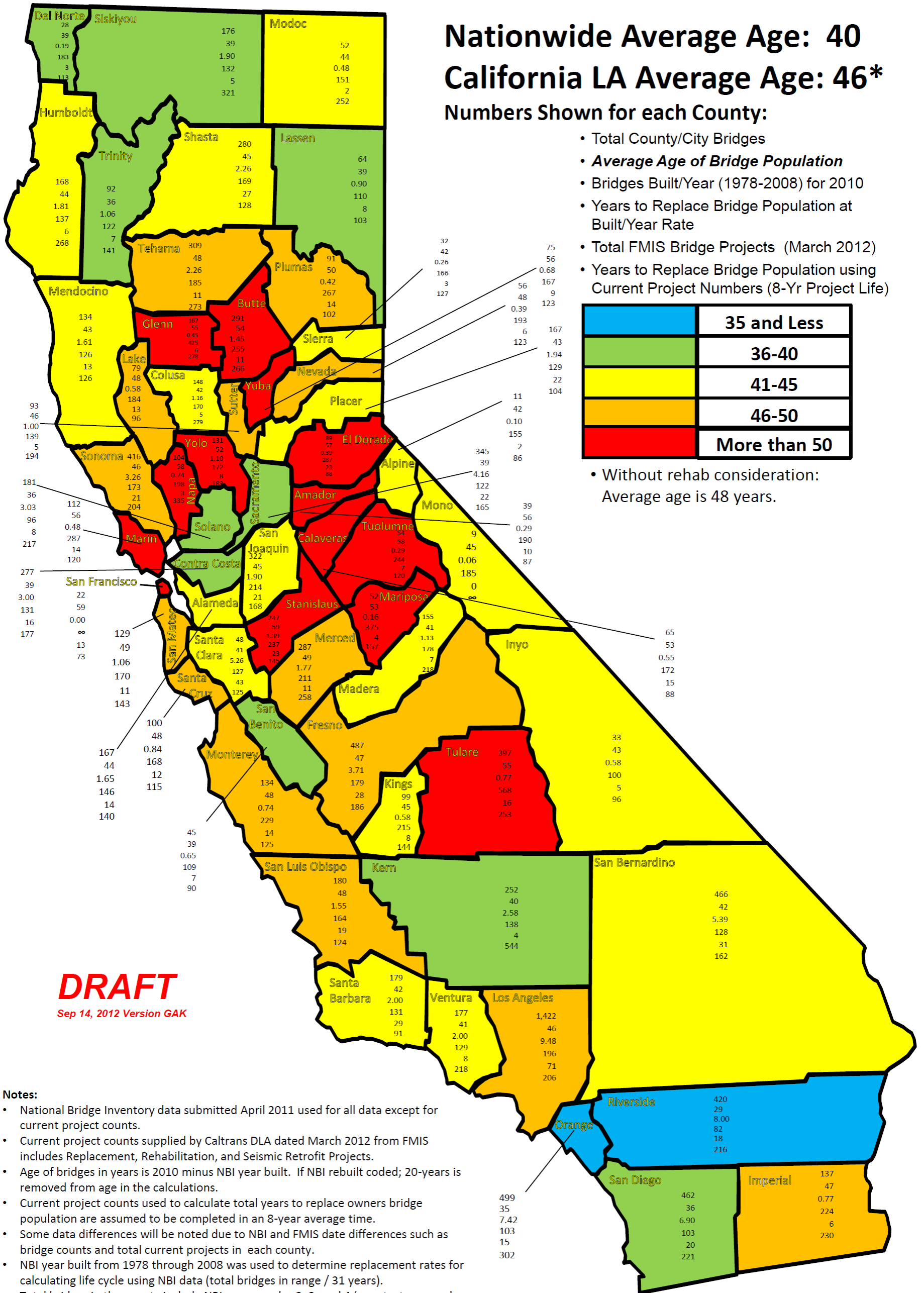

**DRAFT**  
 Sep 14, 2012 Version GAK

- Notes:**
- National Bridge Inventory data submitted April 2011 used for all data except for current project counts.
  - Current project counts supplied by Caltrans DLA dated March 2012 from FMIS includes Replacement, Rehabilitation, and Seismic Retrofit Projects.
  - Age of bridges in years is 2010 minus NBI year built. If NBI rebuilt coded; 20-years is removed from age in the calculations.
  - Current project counts used to calculate total years to replace owners bridge population are assumed to be completed in an 8-year average time.
  - Some data differences will be noted due to NBI and FMIS date differences such as bridge counts and total current projects in each county.
  - NBI year built from 1978 through 2008 was used to determine replacement rates for calculating life cycle using NBI data (total bridges in range / 31 years).
  - Total bridges in the county include NBI owner codes 2, 3, and 4 (county, town, and city owners). Other local agency owned bridges are uncommon.
  - NBI function class 08, 09, and 19 define bridges off Federal-aid routes. All other function class codes are on Federal-aid routes.

## **Appendix E: Bridge Replacement Program**



**Appendix F: List of Weight-Restricted Bridges and Strategy**



SLO County Posted Bridges		Crossing	Load Restriction (tons for 1/2/3 axels)	Comments and Existing Conditions	Replacement Strategy / Plan
1	Dover Canyon Road	Jack Creek	14/23/28	Single span truss - replace in 2018/19	FTIP - programmed for replacement 2019
2	Huasna Townsite Road	Huasna River	13/21/26	Multi-span wood - structurally deficient	SR = 33.7 to be programmed in FTIP
3	Monte Road	Squire Creek	12/19/23	Two-span - wood	SR = 51.6 to be programmed in FTIP
4	Trout Farm Road	Arroyo Grande Creek	11/16/20	Concrete deck - steel stringers - wood bents	Pending State post-rehab inspection
5	Air Park Drive	Oceano Beach Lagoon	8/12/16	Multi-span wood - structurally deficient	FTIP - programmed for replacement 2017
6	Suey Creek Road	Suey Creek	10/17/17	S. span - wood-w/Temp. Bents-Conc Abut&WW	#3 candidate - replace w/ PC/PS Conc Slab
7	Upper Los Berros Road	Los Berros Creek	10/16/16	L=19.2' - 6x16@15" oc - Wood -SS Abutments	#4 candidate-replace w/ PC/PS conc slab-notposted?
8	Upper Los Berros Road	Los Berros Creek	10/16/16	L=16.8' 3x12@12" oc - Wood -SS Abutments	#5 candidate-replace w/ PC/PS conc slab
9	Upper Los Berros Road	Los Berros Creek	13/20/20	L=17.3' - W.O.??? - - Wood -Wood Abutments	#6 candidate-replace w/ PC/PS conc slab
10	Upper Los Berros Road	Los Berros Creek	17/27/27	L=18.7- 4x12@12" oc - Wood -Wood Abutments	#7 candidate-1998 W.O.- replace w/ PC/PS conc slab
11	Morretti Canyon Road, B1	Cattle Crossing	15/25/30	Replace w/1or2-72" HDPE 30'-single span-wood	#2 candidate for County-funded replacement
12	Morretti Canyon Road, B2	Cattle Crossing	15/25/30	Replace w/24" HDPE 30' - single span - wood	#1 candidate for County-funded replacement
13	Morretti Canyon Road, B3	Cattle Crossing	15/26/26	L=18.5' 4x16@12" oc - wood - SS abutments	#8 candidate - replace w/ PC/PS conc slab
14	Arroyo Grande - Huasna Road	Huasna River	20/32/32	Multi-span wd- Str Def-F.O. replace 2018	FTIP - programmed for replacement 2019
15	Dana Foothill Road	Deleissigues Creek	20/32/32	Single span - wood-conc abut and WW	#9 candidate - replace w/ PC/PS conc slab
16	River Grove Drive	Estrella River	12/14/15	Single span truss - replace in 2018/19	FTIP - under review by consultants
17	Las Pilitas Pedestrian Bridge	Salinas River	20/32/32	Single span truss - multi-span wood	now a pedestrian/bike bridge only

**Appendix G: Sample State Bridge Inspection Report (BIR)**



DEPARTMENT OF TRANSPORTATION  
Structure Maintenance & Investigations

LD 154-BR1

Page 1 of 5

Bridge Number : 49C0037  
Facility Carried: DOVER CANYON RD  
Location : 1.3 MI SW OF VINEYARD DR  
City :  
Inspection Date : 08/01/2013

Bridge Inspection Report

Inspection Type  
Routine FC Underwater Special Other

STRUCTURE NAME: JACK CREEK

CONSTRUCTION INFORMATION

Year Built : 1920 Skew (degrees): 0  
Year Widened: N/A No. of Joints : 0  
Length (m) : 19.2 No. of Hinges : 0

Structure Description: Timber plank deck on rolled steel stringers (8) on rolled steel floor beams on riveted steel Warren pony truss on RC abutments on unknown foundations.

Span Configuration : 1@18.3 m

SAFE LOAD CAPACITY AND RATINGS

Design Live Load: M-9 OR H-10  
Inventory Rating: RF=0.35 =>11.3 metric tons Calculation Method: LOAD FACTOR  
Operating Rating: RF=0.49 =>15.9 metric tons Calculation Method: ALLOWABLE STRESS  
Permit Rating : XXXXX  
Posting Load : Type 3: 14 U.S. Tons Type 3S2: 23 U.S. Tons Type 3-3: 28 U.S. Tons

DESCRIPTION ON STRUCTURE

Deck X-Section: 0.25 m br, 4.8 m, 0.25 m br  
Total Width: 5.3 m Net Width: 4.8 m No. of Lanes: 1 Speed: 25 mph  
Min. Vertical Clearance: Unimpaired  
Rail Code: 0000 Rail Description: steel angle

DESCRIPTION UNDER STRUCTURE

Channel Description: gravel

INSPECTION COMMENTARY

SCOPE AND ACCESS

The structure was fully accessible for this routine inspection. The channel was dry at the time of this inspection.

This report serves as part of the routine inspection only and does not replace the independent fracture critical inspection conducted separately (see Fracture Critical Member Inspection Plan, dated 11/11/2008). The next Fracture Critical Member Inspection is scheduled in September 2013.

A Fracture Critical Member Inspection was last performed on 11/07/2012 by the Office of Specialty Investigations and Bridge Management. See the 11/07/2012 report for further fracture critical inspection details. The next fracture critical inspection is due in November 2014.

DECK AND ROADWAY

Surface corrosion is prevalent on the metal bridge rail.

The timber deck continues to exhibit distress in the form of split transverse planks. Longitudinal deck running boards are in place to protect the transverse deck planks, however, those members also exhibit moderate distress. No work is required at this time.

Printed on: Wednesday 11/20/2013 12:03 PM

49C0037/AAAK/27459

INSPECTION COMMENTARY

## SUPERSTRUCTURE

The top chord of the left truss is displaced laterally toward the center of the bridge up to 2 inches when measured from end post to end post along the left truss line (archived photo). This condition will continue to be monitored every 12 months during regular inspection cycles. The displacement has remained unchanged since the 2008 inspection when it was first reported, and appears stable at this time.

There is freckled and light rust throughout all steel elements of this structure including the top and bottom chords, floor beams and steel stringers as previously reported.

Pack rust is evident at the end plates and the end post connections as well as a few other areas of the truss. The distress appears to have remained relatively stable since the November 2010 routine inspection.

Stringers 3, 5 and 6 in Bay 3 continue to exhibit slight bowing without buckling. It does not appear to be structurally significant at this time, and does not warrant analysis. This condition was previously reported and has remained stable.

## SUBSTRUCTURE

The bearings exhibit light corrosion.

There is an area of concrete below the left bearing at Abutment 1 that is missing. Approximately 3 inches of section is spalled off. There appears to be sufficient bearing at this time and the remaining concrete is sound. This condition has had no change since the 2010 inspection and will continue to be monitored during subsequent inspections.

The abutments exhibit typical cracking and abrasion associated with structures of this age. The distress is not structurally significant.

The wingwalls exhibit heavy abrasion without loss of effectiveness.

No scour was observed.

## SAFE LOAD CAPACITY

A Load Rating Summary Sheet dated 10/12/2012 is on file for this structure.

The rating analysis dated 10/16/08 for this structure indicate increases in the Inventory and Operating Ratings to 11.3 tonnes and 15.9 tonnes respectively, and increases in the posting load capacity to 16, 26 and 31 tons for legal truck combinations. The controlling elements for those ratings are truss members L2U3 and L6U5, with the exception of the Inventory Rating which is controlled by the stringers.

Based on the age and condition of the structure, particularly in light of the findings along the left truss line, the existing posting dated 6 June 1986 will remain in effect.

## OPERATIONAL SIGNS

Signs indicating the following load restrictions are in place at both approaches:

14 Tons per vehicle  
23 Tons per semi-trailer  
28 Tons per truck and full trailer

## EXISTING POSTING

Printed on: Wednesday 11/20/2013 12:03 PM

49C0037/AAAK/27459

INSPECTION COMMENTARY

A Posting Order dated 6 June 1986 established the following load limits:

14 Tons per vehicle  
 23 Tons per semi-trailer  
 28 Tons per truck and full trailer

RECOMMENDED POSTING

Retain existing posting.

STEEL INVESTIGATIONS

This structure qualifies for an in-depth Steel investigation because it possesses the following fracture critical or fatigue prone details :

Floor Beams: FC Members,  
 Truss: FC Members

Fracture Critical: Yes                      Inspection Freq.: 24                      Next Inspection: 11/07/2014

<u>ELEMENT INSPECTION RATINGS</u>									
Elem No.	Element Description	Env	Total		Qty in each Condition State				
			Qty	Units	St. 1	St. 2	St. 3	St. 4	St. 5
31	Timber Deck - Bare	2	90	sq.m.	0	90	0	0	0
113	Painted Steel Stringer	2	146	m.	0	0	146	0	0
121	Painted Steel Bottom Chord Thru Truss	2	37	m.	0	0	37	0	0
126	Painted Steel Thru Truss (excl. bottom chord)	2	37	m.	0	0	37	0	0
152	Painted Steel Floor Beam	2	26	m.	0	0	26	0	0
215	Reinforced Conc Abutment	2	10	m.	0	10	0	0	0
311	Moveable Bearing (roller, sliding, etc.)	2	2	ea.	0	2	0	0	0
313	Fixed Bearing	2	2	ea.	0	2	0	0	0
330	Metal Bridge Railing - coated or uncoated	2	37	m.	0	0	37	0	0
357	Pack Rust	2	1	ea.	0	1	0	0	0

WORK RECOMMENDATIONS

RecDate: 11/11/2008                      EstCost:                      Closely monitor the top chord of the left  
 Action : Bridge-Misc                      StrTarget:                      truss for any increase in lateral  
 Work By: LOCAL AGENCY                      DistTarget:                      displacement. Suggest every 3 months as a  
 Status : PROPOSED                      EA:                      minimum.

RecDate: 08/30/2006                      EstCost:                      Monitor bearing location at Abutment 1  
 Action : Bridge-Misc                      StrTarget:                      left periodically between compliance  
 Work By: LOCAL AGENCY                      DistTarget:                      inspections (suggest every 6 months  
 Status : PROPOSED                      EA:                      minimum).

Team Leader : Anthony Fernandes  
Report Author : Anthony Fernandes  
Inspected By : A.Fernandes/R.Nand



11/20/13

Anthony Fernandes (Registered Civil Engineer) (Date)



STRUCTURE INVENTORY AND APPRAISAL REPORT

```

***** IDENTIFICATION *****
(1) STATE NAME- CALIFORNIA                                069
(8) STRUCTURE NUMBER                                     49C0037
(5) INVENTORY ROUTE(ON/UNDER)- ON 140000000
(2) HIGHWAY AGENCY DISTRICT                             05
(3) COUNTY CODE 079 (4) PLACE CODE 00000
(6) FEATURE INTERSECTED- JACK CREEK
(7) FACILITY CARRIED- DOVER CANYON RD
(9) LOCATION- 1.3 MI SW OF VINEYARD DR
(11) MILEPOINT/KILOMETERPOINT 0
(12) BASE HIGHWAY NETWORK- NOT ON NET 0
(13) LRS INVENTORY ROUTE & SUBROUTE
(16) LATITUDE 35 DEG 34 MIN 39.96 SEC
(17) LONGITUDE 120 DEG 50 MIN 05.83 SEC
(98) BORDER BRIDGE STATE CODE % SHARE %
(99) BORDER BRIDGE STRUCTURE NUMBER

***** STRUCTURE TYPE AND MATERIAL *****
(43) STRUCTURE TYPE MAIN:MATERIAL- STEEL
      TYPE- TRUSS - THRU CODE 310
(44) STRUCTURE TYPE APPR:MATERIAL- OTHER/NA
      TYPE- OTHER/NA CODE 000
(45) NUMBER OF SPANS IN MAIN UNIT 1
(46) NUMBER OF APPROACH SPANS 0
(107) DECK STRUCTURE TYPE- TIMBER CODE 8
(108) WEARING SURFACE / PROTECTIVE SYSTEM:
  A) TYPE OF WEARING SURFACE- TIMBER CODE 7
  B) TYPE OF MEMBRANE- NONE CODE 0
  C) TYPE OF DECK PROTECTION- NONE CODE 0

***** AGE AND SERVICE *****
(27) YEAR BUILT 1920
(106) YEAR RECONSTRUCTED 0000
(42) TYPE OF SERVICE: ON- HIGHWAY 1
      UNDER- WATERWAY 5
(28) LANES:ON STRUCTURE 01 UNDER STRUCTURE 00
(29) AVERAGE DAILY TRAFFIC 151
(30) YEAR OF ADT 2007 (109) TRUCK ADT 1 %
(19) BYPASS, DETOUR LENGTH 199 KM

***** GEOMETRIC DATA *****
(48) LENGTH OF MAXIMUM SPAN 18.3 M
(49) STRUCTURE LENGTH 19.2 M
(50) CURB OR SIDEWALK: LEFT 0.0 M RIGHT 0.0 M
(51) BRIDGE ROADWAY WIDTH CURB TO CURB 4.8 M
(52) DECK WIDTH OUT TO OUT 5.3 M
(32) APPROACH ROADWAY WIDTH (W/SHOULDERS) 4.0 M
(33) BRIDGE MEDIAN- NO MEDIAN 0
(34) SKEW 0 DEG (35) STRUCTURE FLARED NO
(10) INVENTORY ROUTE MIN VERT CLEAR 99.99 M
(47) INVENTORY ROUTE TOTAL HORIZ CLEAR 4.8 M
(53) MIN VERT CLEAR OVER BRIDGE RDWY 99.99 M
(54) MIN VERT UNDERCLEAR REF- NOT H/RR 0.00 M
(55) MIN LAT UNDERCLEAR RT REF- NOT H/RR 0.0 M
(56) MIN LAT UNDERCLEAR LT 0.0 M

***** NAVIGATION DATA *****
(38) NAVIGATION CONTROL- NO CONTROL CODE 0
(111) PIER PROTECTION- CODE
(39) NAVIGATION VERTICAL CLEARANCE 0.0 M
(116) VERT-LIFT BRIDGE NAV MIN VERT CLEAR M
(40) NAVIGATION HORIZONTAL CLEARANCE 0.0 M

***** SUFFICIENCY RATING *****
SUFFICIENCY RATING = 19.2
STATUS STRUCTURALLY DEFICIENT
HEALTH INDEX 51.8
PAINT CONDITION INDEX = 50.0

***** CLASSIFICATION ***** CODE
(112) NBIS BRIDGE LENGTH- YES Y
(104) HIGHWAY SYSTEM- NOT ON NHS 0
(26) FUNCTIONAL CLASS- LOCAL RURAL 09
(100) DEFENSE HIGHWAY- NOT STRAHNET 0
(101) PARALLEL STRUCTURE- NONE EXISTS N
(102) DIRECTION OF TRAFFIC- 1 LANE, 2 WAY 3
(103) TEMPORARY STRUCTURE-
(105) FED.LANDS HWY- NOT APPLICABLE 0
(110) DESIGNATED NATIONAL NETWORK - NOT ON NET 0
(20) TOLL- ON FREE ROAD 3
(21) MAINTAIN- COUNTY HIGHWAY AGENCY 02
(22) OWNER- COUNTY HIGHWAY AGENCY 02
(37) HISTORICAL SIGNIFICANCE- NOT ELIGIBLE 5

***** CONDITION ***** CODE
(58) DECK 6
(59) SUPERSTRUCTURE 4
(60) SUBSTRUCTURE 6
(61) CHANNEL & CHANNEL PROTECTION 7
(62) CULVERTS N

***** LOAD RATING AND POSTING ***** CODE
(31) DESIGN LOAD- M-9 OR H-10 1
(63) OPERATING RATING METHOD- ALLOWABLE STRESS 2
(64) OPERATING RATING- 15.9
(65) INVENTORY RATING METHOD- LOAD FACTOR 1
(66) INVENTORY RATING- 11.3
(70) BRIDGE POSTING- > 39.9% BELOW 0
(41) STRUCTURE OPEN, POSTED OR CLOSED-
      DESCRIPTION- POSTED FOR LOAD P

***** APPRAISAL ***** CODE
(67) STRUCTURAL EVALUATION 4
(68) DECK GEOMETRY 3
(69) UNDERCLEARANCES, VERTICAL & HORIZONTAL N
(71) WATER ADEQUACY 9
(72) APPROACH ROADWAY ALIGNMENT 4
(36) TRAFFIC SAFETY FEATURES 0000
(113) SCOUR CRITICAL BRIDGES 5

***** PROPOSED IMPROVEMENTS *****
(75) TYPE OF WORK- REPLACE FOR DEFICIENC CODE 31
(76) LENGTH OF STRUCTURE IMPROVEMENT 19.2 M
(94) BRIDGE IMPROVEMENT COST $232,300
(95) ROADWAY IMPROVEMENT COST $46,460
(96) TOTAL PROJECT COST $390,264
(97) YEAR OF IMPROVEMENT COST ESTIMATE 2010
(114) FUTURE ADT 205
(115) YEAR OF FUTURE ADT 2034

***** INSPECTIONS *****
(90) INSPECTION DATE 08/13 (91) FREQUENCY 12 MO
(92) CRITICAL FEATURE INSPECTION: (93) CPI DATE
  A) FRACTURE CRIT DETAIL- YES 24 MO A) 11/12
  B) UNDERWATER INSP- NO MO B)
  C) OTHER SPECIAL INSP- NO MO C)

```

**Appendix H: Sample SLO County Bridge Inspection Form**



**SLO COUNTY – BRIDGE INSPECTION FORM (Bridges ≤ 20' long)**

Date _____	Structure Name _____
Temperature _____	Structure No. _____
Inspected By _____	Structure Type _____
	Location _____
	ADT/Year _____
	Functional Classification _____

**58 OVERALL DECK CONDITION RATING: 10 9 8 7 6 5 4 3 2 1 0 x 2 = 20 pts possible \_\_\_\_\_**

Comments: \_\_\_\_\_  
 \_\_\_\_\_  
 \_\_\_\_\_

<u>Deck Elements</u>	<u>Rating</u> <small>Good/Fair/Poor/Not Applicable)</small>				<u>Remarks</u>
Wearing Surface	G	F	P	N/A	_____
Deck – Topside	G	F	P	N/A	_____
Deck – Soffit	G	F	P	N/A	_____
Curbs	G	F	P	N/A	_____
Medians	G	F	P	N/A	_____
Sidewalks	G	F	P	N/A	_____
Parapets	G	F	P	N/A	_____
Railing	G	F	P	N/A	_____
Expansion Joints	G	F	P	N/A	_____
Drainage System	G	F	P	N/A	_____
Utilities (Overhead)	G	F	P	N/A	_____
_____	G	F	P	N/A	_____
_____	G	F	P	N/A	_____

**59 OVERALL SUPERSTRUCTURE CONDITION RATING: 10 9 8 7 6 5 4 3 2 1 0 x 2 = 20 pts possible \_\_\_\_\_**

Comments: \_\_\_\_\_  
 \_\_\_\_\_  
 \_\_\_\_\_

<u>Superstructure Elements</u>	<u>Rating</u>				<u>Remarks</u>
Stringers	G	F	P	N/A	_____
Floor beams	G	F	P	N/A	_____
Floor System Bracing	G	F	P	N/A	_____
Multi beams	G	F	P	N/A	_____
Girders	G	F	P	N/A	_____
Trusses - General	G	F	P	N/A	_____
Upper Chords	G	F	P	N/A	_____
Web Members	G	F	P	N/A	_____
Lower Chords	G	F	P	N/A	_____
Lateral Bracing	G	F	P	N/A	_____
Sway Bracing	G	F	P	N/A	_____
Portals	G	F	P	N/A	_____
Arches	G	F	P	N/A	_____
Cables	G	F	P	N/A	_____
PCI – Paint – PCI ( )	G	F	P	N/A	_____
Bearing Devices	G	F	P	N/A	_____
Connections	G	F	P	N/A	_____
Welds	G	F	P	N/A	_____
_____	G	F	P	N/A	_____
_____	G	F	P	N/A	_____
_____	G	F	P	N/A	_____

**60 OVERALL SUBSTRUCTURE CONDITION RATING: 10 9 8 7 6 5 4 3 2 1 0 x 2 = 20 pts possible \_\_\_\_\_**

Comments: \_\_\_\_\_  
 \_\_\_\_\_

<u>Substructure Elements</u>	<u>Rating</u>				<u>Remarks</u>
Abutments	G	F	P	N/A	_____
Piles	G	F	P	N/A	_____
Footing	G	F	P	N/A	_____
Stem	G	F	P	N/A	_____
Bearing Seat	G	F	P	N/A	_____
Back wall	G	F	P	N/A	_____
Wing walls	G	F	P	N/A	_____
Piers and Bents	G	F	P	N/A	_____
Piles	G	F	P	N/A	_____
Footing	G	F	P	N/A	_____
Columns(s)/Stem	G	F	P	N/A	_____
Cap	G	F	P	N/A	_____
Lateral Bracing	G	F	P	N/A	_____
Longitudinal Bracing	G	F	P	N/A	_____
(113)-Scour/Undermining ( )	G	F	P	N/A	_____
PCI – Paint – PCI ( )	G	F	P	N/A	_____

**61 OVERALL CHANNEL AND CHANNEL PROTECTION CONDITION RATING: 10 9 8 7 6 5 4 3 2 1 0 \_\_\_\_\_**

Comments: \_\_\_\_\_  
 \_\_\_\_\_

<u>Channel Elements</u>	<u>Remarks</u>
Channel	_____
Streambed (align, scour, etc.)	_____
Embankments (vegetation, etc.)	_____
Stream flow (velocity, etc.)	_____
Drift and Debris	_____

	<u>Rating</u>				<u>Remarks</u>
Channel Protection	G	F	P	N/A	_____
Riprap	G	F	P	N/A	_____
Guide banks or Spur Dikes	G	F	P	N/A	_____
Gabions	G	F	P	N/A	_____
Slope Protection	G	F	P	N/A	_____
Footing Aprons	G	F	P	N/A	_____

**71 WATERWAY ADEQUACY APPRAISAL RATING: 10 9 8 7 6 5 4 3 2 1 0 \_\_\_\_\_**

Comments: \_\_\_\_\_  
 \_\_\_\_\_

<u>Waterway Elements</u>	<u>Remarks</u>
Hydraulic Opening	_____
Freeboard	_____
Span	_____
Floodplain	_____
Chance of Overtopping	_____
Remote	_____
Slight	_____
Occasional	_____
Frequent	_____
Overtopping Traffic Delays	_____
Insignificant	_____
Significant	_____
Severe	_____

**72 APPROACH ROADWAY ALIGNMENT APPRAISAL RATING: 10 9 8 7 6 5 4 3 2 1 0 \_\_\_\_\_**

Comments: \_\_\_\_\_  
 \_\_\_\_\_  
 \_\_\_\_\_

<u>Approach Elements</u>	<u>Rating</u>				<u>Remarks</u>
Pavement Condition	G	F	P	N/A	_____
Vertical Alignment (Abut 1)	G	F	P	N/A	_____
Horizontal Alignment (Abut 1)	G	F	P	N/A	_____
Vertical alignment (Abut 2)	G	F	P	N/A	_____
Horizontal Alignment (Abut 2)	G	F	P	N/A	_____
Speed Limit = _____ MPH					
Weight Restrictions = _____ Tons _____ Tons/Comb.					

**75 RECOMMENDED WORK RATING = Maint. Cost Estimate (MC), Replacement Cost Estimate (RC)**  
**RATING =  $\frac{RC - MC}{10}$  (10) = \_\_\_\_\_ 10 pts possible**  
**RC**

\_\_\_\_\_  
 \_\_\_\_\_  
 \_\_\_\_\_  
 \_\_\_\_\_  
 \_\_\_\_\_  
 \_\_\_\_\_  
 \_\_\_\_\_

**\* OVERALL BRIDGE CONDITION RATING: (Sufficiency Rating) \***

- 58 \_\_\_\_\_ (20 pts possible)
- 59 \_\_\_\_\_ (20 pts possible)
- 60 \_\_\_\_\_ (20 pts possible)
- 61 \_\_\_\_\_ (10 pts possible)
- 71 \_\_\_\_\_ (10 pts possible)
- 72 \_\_\_\_\_ (10 pts possible)
- 75 \_\_\_\_\_ (10 pts possible)

**TOTAL \_\_\_\_\_ (100 pts possible)**

## **Appendix I: Post-Earthquake Bridge Inspections Memorandum**

September 28, 2012

**PROCEDURAL MEMORANDUM M-40**

**TO:** Engineering/Road Maintenance Staff  
**FROM:** Dave Flynn, Deputy Director – Public Works  
**SUBJECT:** Post-Earthquake Bridge Inspections

Objective: The following procedure outlines bridge inspector’s actions for assigned staff to be performed subsequent to a significant earthquake event as defined in this memo. The goal is to provide timely assessment of critical structures, centralize information for deployment of resources, direct outside assistance as needed, and to catalog damage for potential emergency declaration.

1. Introduction

The maintenance and repair of the County Roadway System is the responsibility of the Department of Public Works. After a seismic event, there is a potential for widespread damage to occur which may strain the resources available at the time of the event. In order to assess situations on the ground and deploy resources to the priority locations, it is necessary to establish field teams to assess bridge conditions for structural adequacy. Creation of these teams will provide for a report to a central source achieving the following:

- Determine viability of critical routes
- Deploy available resources to the most critical need
- Notice public of roadway conditions
- Focus subsequent Caltrans inspection on key locations
- Document damage for emergency declarations and subsequent action

- Prioritize repairs
- Assure system integrity post-event; barricade any routes of concern

## 2. Scope

The County Public Works Department is comprised of multiple divisions. Existing staff from these divisions are already assigned to the Public Works Department Operations Center (PWDOC)/Storm Center to provide coordinated response during emergency events due to flooding, tsunamis, earthquakes, or Diablo Canyon Nuclear Power Plant incidents. In addition to the PWDOC/Storm Center staffing, there is a need to have sufficient staff assigned to review conditions in the field, assess any immediate actions, report status, and document damage. While field road staff may conduct these assessments for the County's roughly 200 bridges, it is necessary to engage trained office staff to make the evaluation in the event of a major seismic event. In the event that the major seismic event creates an implementation of the Nuclear Power Plant Emergency Response Plan, this evaluation will enhance Public Works primary role of emergency road repair and in coordination of evacuation routes with Sheriff and CHP.

## 3. Responsibilities

The following Public Works staff will be involved in the Bridge Inspection response:

### 3.1 Transportation Program Manager

The Transportation Program Manager (TPM) will play the central role in initiation of inspection and the central receiving point for bridge damage reports. The TPM will be posted adjacent to PWDOC.

- 3.1.1 Implement the Bridge Inspection Response Plan upon notification conditions noted in Section 4 "Operations Plan"
- 3.1.2 Deploy inspection teams
- 3.1.3 Receive and track bridge inspection reports
- 3.1.4 Provide central clearinghouse of bridge status
- 3.1.5 Notice Director of Public Works (DPW), Transportation Manager, Roads Manager, and PWDOC Director of status
- 3.1.6 Establish documentation of damage via SAP reporting and field evidence received from the teams
- 3.1.7 Direct State Bridge Inspectors to key locations
- 3.1.8 Assure assigned staff is trained on procedure and drill is run biannually

### 3.2 Roads Manager (RM)

The Roads Manager will oversee field operations in response to situations on the ground, which develop during the event. The RM may be located at the County EOC depending on the emergency conditions and any site declaration from Diablo Canyon. The RM will:

- 3.2.1 Deploy field crews as warranted
- 3.2.2 Direct barricades be placed at structures deemed to be unsound
- 3.2.3 Acquire additional field resources, as needed, to respond to site conditions
- 3.2.4 Request Public Works Mutual Aid Agreement Resource if conditions warrant

### 3.3 Bridge Inspector Team Leaders (BITL)

The Bridge Inspection Team Leader (BITL) will each be assigned one of three areas (North Coast, North County, South County) which will be their responsibility for review of the structures listed within that zone. The BITL will:

- 3.3.1 Direct the deployment for inspection of themselves and the assigned Assistant Bridge Inspector
- 3.3.2 Assure Response Inspection sheet is completed for each structure (future electronic format via tablet)
- 3.3.3 Assess bridges for continued operation
- 3.3.4 Assure information is reported timely to the TPM as inspections are completed
- 3.3.5 Document damage with photographs and detailed notes
- 3.3.6 Recommend repair or emergency stabilization work to the TPM and the RM
- 3.3.7 Complete log of status of bridges in assigned zones

### 3.4 Assistant Bridge Inspectors (ABI)

For each BITL, there will be at least one assigned ABI. Their responsibility will be to work at the BITL's direction which may be as a field partner or as an independent inspector for the bridge assigned. The ABI will:

- 3.4.1 Complete forms of bridge inspections as assigned by BITL
- 3.4.2 Report status of bridges to the BITL or if delegated by the BITL to the TPM
- 3.4.3 Document any damage of structures
- 3.4.4 Assist Road field crews, if directed by the BITL, to respond at specific locations

Staffing will require participation of the Transportation, Design, and Construction Divisions and the current assignments are shown as Attachment A.

## 4. Operations Plan

### 4.1 General Operations

The plan will be initiated based on the following conditions:

- 1. A magnitude 6.0 earthquake on the Richter scale which occurs in either San Luis Obispo, Monterey or Santa Barbara Counties.
- 2. Receipt of call, subsequent to a noticeable seismic event, which indicates damage to a bridge.
- 3. As directed by the Director of Public Works.

### 4.2 Seismic Alert

The following individuals shall have USGS seismic alert function attached to their cell phones meeting the aforementioned criteria:

- 1. Roads Manager
- 2. Transportation Manager
- 3. Transportation Programs Manger
- 4. Deputy Director of Public Works, Engineering Services

4.2.2 The Transportation Manager or Deputy Director shall notify the Director of Public Works when the Inspection Operations Plan initiated.



4.2.3 The TPM will alert the BITL and ABI to report immediately to the courthouse for deployment.

4.2.4 Command responsibility will reside with the TPM.

4.2.5 The TPM will contact Caltrans Structure Maintenance to request assistance in evaluating structures.

4.2.6 Unless known site **conditions** would direct forces to a specific location, inspection teams will begin assessments as follows:

4.2.6.a ***The inspection team assigned to South County shall inspect all bridges in the Avila Beach area first, urbanized area second and rural areas third.***

4.2.6.b ***The inspection team assigned to North Coast shall inspect all bridges in the Los Osos area first, urbanized area second and rural areas third.***

4.2.6.c ***The inspection team assigned to North County shall inspect the Templeton Road Bridge over the Salinas River first, urbanized area second and rural areas third.***

#### 4.3 Equipment Available

4.3.1 Field Kit: There will be three prepackaged Field bags for the field inspection teams and they will be located in the Construction Division office at Monterey and Toro Streets. The kits will contain:

- a. Two flashlights
- b. Small First Aid Kit
- c. Copies of Inspection Logs
- d. Map of area
- e. Overall list of bridges in area
- f. Digital cameras
- g. Clipboards
- h. Warning tape
- i. Closed signs

These kits will be checked by TPM biannually.

4.3.2 Vehicles Available to BITL/ABI:

Construction Division trucks will be made available to the inspection teams. Keys are located in the Construction Division office.

4.3.3 Equipment Rental:

BITL/ABI will be allowed to rent equipment they deem necessary to either close structure or provide emergency stabilization or for further structure investigations.

4.4 Actions/Response

Field staff may take any of the following actions:

4.4.1 Clear structure for use, relay clearance to TPM.

4.4.2 Mark bridge as requiring additional assessment but leave open, note to TPM.

4.4.3 Request RM deploy barricades to close bridge. Note to TPM.

4.4.4 In rare instances, recommend that actions be made by others to stabilize the structure.

4.5 Follow-up Actions

The TPM will continue to act post event to follow-up on actions undertaken by the BITL's. This would include:

4.5.1 Deploy Caltrans structure inspectors to site of critical structures.

4.5.2 Release list of bridge status to PWDOC, EOS, DPW.

4.5.3 Compile inspection reports and photographs and establish SAP work orders for locations of damage.

4.5.4 Develop estimate of damage costs.

4.5.5 Develop report of field repair costs for each site, via SAP, with the Accounting Division. Define for on-system and off-system locations.

The latter action anticipates declaration of local emergency and subsequent federal emergency aid. Early documentation of damages and labor costs is an essential element to this response plan.

#### 4.6 Termination of Plan

The Transportation Manager or Deputy Director of Public Works shall terminate Plan at recommendation of the TPM and will notify the Director of Public Works.

#### 4.7 Training

The TPM will gather the inspection team together at least biannually and conduct a training session on post-earthquake bridge inspections, what to look for and document Determination of Actions.

#### Attachments:

- A. Staffing Plan
- B. North Coast Structure Map/List
- C. North County Structure Map/List
- D. South County Structure Map/List
- E. Inspection Form
- F. Fault Map and 100 Mile Radius Map
- G. Bridge Definitions Guide

c: Construction Division Manager

R:\Bridges\Earthquake Bridge Inspections\DRAFT Procedural Memorandum M-40(Post Earthquake Bridge Inspections).doc.DF:mac/lc

**Attachment A**

***“Proposed”***

Post-Earthquake Bridge Inspection Teams

(July 15, 2012)

Transportation Program Manager - Don Spagnolo  
Road Manager – Tim Cate

North County Bridges

BITL - Cori Marsalek  
ABI - Jason Rath  
(Alternate – Vacant)

North Coast Bridges

BITL - Frank Cunningham  
ABI - Tiburcio Perez  
(Alternate – Jason Rath)

South County Bridges

BITL – Kidd Immel  
ABI - Matt Reinhart  
(Alternate – Genaro Diaz)

## **Appendix J: List of Stream Crossing Locations and Potential Mitigation Barriers**

## San Luis Obispo County-Fish Passage Evaluation

**Table 3.** Site ID numbers for 50 San Luis Obispo County stream crossing locations and potential migration barriers (in alphabetical order by stream).

<u>Site ID#</u>	<u>Stream Name</u>	<u>Road Name/Site Location</u>
5	Arroyo Grande Creek	Cechetti Rd.
6	Arroyo Grande Creek	Unnamed Rd (Biddle Park)
166	Atascadero Creek	Gas encasement 0.1 m from Curbaril
19	Brizzolari Creek	Unnamed Road (Cal Poly)
21	Brizzolari Creek	Highland Dr.
22	Brizzolari Creek Poly	Canyon Rd.
130	Coon Creek Pechos	Valley Rd.
4	Corbit Canyon Ck (a.k.a. Tally Ho Creek)	East Branch St.
38	Curti Creek	Santa Rosa Creek Rd.
92	Davenport Creek	Jespersion Rd.
97	Dry Creek	Santa Fe Rd.
98	Dry Creek	Santa Fe Rd.
57	Graves Creek	Santa Ana Rd.
121	Little Morro Creek	Little Morro Rd.
122	Little Morro Creek	Little Morro Rd.
196	Los Berros Creek	Valley Rd. (nearest)
8	N. Fork Graves Creek	N. Fork Graves Creek
90	Paloma Creek	El Camino Real
91	Pismo Creek	Unnamed Road (Unpaved)
31	Prefumo Creek	Los Osos Valley Rd.
32	Prefumo Creek	Madonna Rd.
30	San Luis Obispo Creek	Los Osos Valley Rd.
195	San Luis Obispo Creek	Marsh St.
67	Santa Margarita Creek	El Camino Real
34	Santa Rosa Creek	Burton Dr.
36	Santa Rosa Creek	Ferrasci Rd.
81	See Canyon Creek	San Luis Bay Dr.
82	See Canyon Creek	Black Walnut
83	See Canyon Creek	Black Walnut
41	South Fork Santa Rosa Creek	Santa Rosa Creek Rd.
13	Stenner Creek	Stenner Creek Rd.
14	Stenner Creek	Stenner Creek Rd.
18	Stenner Creek	Highland Dr.
23	Stenner Creek	Foothill Blvd.
24	Stenner Creek	Murray St.
68	Trout Creek	Asuncion Rd.
46	Unnamed	San Simeon Creek Rd.
76	Unnamed	Toro Creek Rd.
79	Unnamed	Toro Creek Rd.

<u>Site ID#</u>	<u>Stream Name</u>	<u>Road Name/Site Location</u>
101	Unnamed	Poinsetta St.
104	Unnamed	Poinsetta St.
105	Unnamed	Spanish Oaks Dr.
106	Unnamed	Railroad Crossing- Spanish Oaks Dr.
125	Unnamed	Santa Rosa Creek Rd.
145	Unnamed	Santa Rosa Creek Rd.
167	Van Gordon Creek	San Simeon Creek Rd.
88	West Corral de Piedra Creek	Righetti Rd.
127	Yerba Buena Creek	I St.
129	Yerba Buena Creek	El Camino Real
165	Yerba Buena Creek	Railroad Crossing- El Camino Real

Note: See San Luis County Stream Crossing Inventory and Fish Passage Evaluation, published March 2005, for additional information regarding site ID #, site ranking and comments about each site.